

WESTAR
EST. 1986



2022 APPLICATION **CATALOG & INTERCHANGE**

| Air Suspension | Coil Spring Conversion Kit | Strut Mount |

DOMESTIC & IMPORT CARS & TRUCKS



This combined catalog incorporates all suspension related products that Westar manufactures, including:

Air Springs:

Our air springs are manufactured and tested to guarantee performance exceeding the OE design. Westar offers a 12 month /12,000 mile warranty on these units. Packed and sold 1 per box.

Air Struts:

Westar Air Struts are packed individually. Our catalog calls for either 1 or 2 per car. In some applications the right side is different from the left side. Westar is backing these with a 12 month/12,000 mile warranty.

Compressor – Dryer Assembly:

Assembled and ready to install. All units come with vibration dampeners and all necessary brackets. Efficient design guarantees minimal amperage draw.

Dryers:

Dryers are manufactured to meet or exceed the demands on the system. ALWAYS REPLACE THE DRYER WHENEVER THE SYSTEM IS OPENED TO THE ATMOSPHERE TO PREVENT MOISTURE DAMAGE.

Solenoids:

Air spring solenoids are an exact fit to the Air Spring. They come with a complete O-Ring seal kit.

Conversion Kits:

Conversion kits are sometimes desired to change the vehicle to a conventional coil spring suspension. For those car owners, Westar offers a kit to do just that. The kits include all parts necessary to do the job right and come with a complete set of instructions. Kits are sold either by axle set or complete 4 wheel set. Some kits include an optional set of shock absorbers to replace the tired old shocks that are on the car.

East Coast Warehouse

350 Winmeyer Ave
Suite: B
Odenton, MD 21113
P: (301)490-0010
F: (866)730-9718

West Coast Warehouse

1566 S. Archibald Ave.
Ontario, CA 91761
P: (301)490-0010 ext. 270
or
Local: (714)909-8030



Table of Contents

Air Suspension Parts

<u>Make</u>	<u>Page</u>	<u>Make</u>	<u>Page</u>
Audi	1	Lexus	26
Bently.....	3	Lincoln	27
BMW	3	Maserati	31
Buick	7	Maybach	31
Cadillac	8	Mercedes Benz .	32
Chevrolet	15	Mercury	46
Chrysler.....	17	Nissan	47
Dodge.....	17	Oldsmobile	47
Ford	17	Pontiac	49
GMC	20	Porsche	49
Hummer.....	21	RAM Truck	50
Infiniti.....	22	SAAB	50
IHC	22	Saturn	50
Isuzu	22	Tesla	51
Jaguar	22	Toyota	51
Jeep	23	Volkswagen	51
KIA	23	Volvo	52
Land Rover	23		
		Medium Heavy Duty Truck / Universal	53

Suspension Shock and Strut Mounts

<u>Make</u>	<u>Page</u>	<u>Make</u>	<u>Page</u>
Acura	55	GEO	74
Audi	56	GMC	75
BMW	57	Honda	75
Buick	60	Hyundai	77
Cadillac	62	Infinity	78
Chevrolet	63	Isuzu	79
Chrysler	65	Jaguar	79
Daihatsu	68	Jeep	79
Dodge	68	Kia	79
Eagle.....	71	Land Rover	81
Ford	72	Lexus	81

<u>Make</u>	<u>Page</u>
Lincoln	82
Mazda	82
Mercedes Benz .	84
Mercury	85
Mini	87
Mitsubishi	87
Nissan	88
Oldsmobile	91
Plymouth	92
Pontiac	94
Porsche	96
RAM Truck	96

<u>Make</u>	<u>Page</u>
Renault	96
SAAB	96
Saturn	96
Scion	97
Seat	97
Subaru	98
Suzuki	99
Tesla	99
Toyota	99
Volkswagen	102
Volvo	103

Buyers Guide... 105

Interchanges.... 184

Air Spring Suspension

Part Type	Year	Location	Description	Part No.	Std Pack	Qty/Car
AUDI PASSENGER CAR						
A6						
ALL						
AIR COMPRESSOR	2012-18			CD-7748	Each	1
	2006-11			CD-7733	Each	1
AIR SPRING-REAR	2006-11	Rear		AS-7027	Each	2
AIR STRUT - FRONT LEFT	2006-11	Front Left		AS-7364	Each	1
AIR STRUT - FRONT RIGHT	2006-11	Front Right		AS-7365	Each	1
CONTROL VALVE	2012-18			CV-0012	Each	1
	2006-11			CV-0004	Each	1
Front	2012-18	Front		HS-8509	Each	1
		Front		HS-8508	Each	1
Mexico						
AIR COMPRESSOR	2005			CD-7733	Each	1
AIR SPRING-REAR	2005	Rear		AS-7027	Each	2
AIR STRUT - FRONT LEFT	2005	Front Left		AS-7364	Each	1
AIR STRUT - FRONT RIGHT	2005	Front Right		AS-7365	Each	1
CONTROL VALVE	2005			CV-0004	Each	1
A6 QUATTRO						
ALL						
AIR COMPRESSOR	2012-18			CD-7748	Each	1
	2005-11			CD-7733	Each	1
AIR SPRING-REAR	2005-11	Rear		AS-7027	Each	2
AIR STRUT - FRONT LEFT	2005-11	Front Left		AS-7364	Each	1
AIR STRUT - FRONT RIGHT	2005-11	Front Right		AS-7365	Each	1
CONTROL VALVE	2012-18			CV-0012	Each	1
	2005-11			CV-0004	Each	1
Front	2012-18	Front		HS-8509	Each	1
		Front		HS-8508	Each	1
A7 QUATTRO						
ALL						
AIR COMPRESSOR	2012-18			CD-7748	Each	1
AIR SPRING-REAR LEFT	2012-18	Rear Left		AS-7084	Each	1
AIR SPRING-REAR RIGHT	2012-18	Rear Right		AS-7085	Each	1
CONTROL VALVE	2012-18			CV-0012	Each	1
Front	2012-18	Front		HS-8509	Each	1
		Front		HS-8508	Each	1
A8 QUATTRO						
ALL						
AIR COMPRESSOR	2012-18			CD-7748	Each	1
AIR STRUT - FRONT LEFT	2002-10	Front Left	w/ Standard Suspension	AS-7325	Each	1
		Front Left	w/ Sport Suspension	AS-7358	Each	1
AIR STRUT - FRONT RIGHT	2002-10	Front Right	w/ Standard Suspension	AS-7326	Each	1
		Front Right	w/ Sport Suspension	AS-7359	Each	1
AIR STRUT - REAR LEFT	2002-10	Rear Left	w/ Standard Suspension	AS-7352	Each	1
AIR STRUT - REAR RIGHT	2002-10	Rear Right	w/ Standard Suspension	AS-7353	Each	1
COMPRESSOR - DRYER	2005-09		W12 Engine	CD-7735	Each	1
	2002-10		V8 Engine	CD-7734	Each	1
CONTROL VALVE	2012-18			CV-0012	Each	1
	2002-10			CV-0004	Each	1
A8						
ALL						
Front	2015-16	Front		HS-8509	Each	1
		Front		HS-8508	Each	1
A8 QUATTRO						
ALL						
Front	2012-18	Front		HS-8509	Each	1
		Front		HS-8508	Each	1

Air Spring Suspension

Part Type	Year	Location	Description	Part No.	Std Pack	Qty/Car
AUDI PASSENGER CAR (continued)						
ALLROAD QUATTRO						
ALL						
AIR SPRING-FRONT	2001-05	Front	Aftermarket Design	AS-7052	Each	2
		Front	OEM Design	AS-7070	Each	2
AIR SPRING-REAR LEFT	2001-05	Rear Left	OEM Design	AS-7071	Each	1
AIR SPRING-REAR RIGHT	2001-05	Rear Right	OEM Design	AS-7072	Each	1
AIR STRUT - FRONT	2001-05	Front		AS-7322	Each	2
AIR STRUT - REAR LEFT	2001-05	Rear Left	Left Side	AS-7323	Each	1
AIR STRUT - REAR RIGHT	2001-05	Rear Right	Right Side	AS-7324	Each	1
AIR-COIL SPRING CONV KT [FRONT & REAR]	2001-05	Front and Rear	Coil Over Strut	CK-7854	Kit	1
AIR-COIL SPRING CONVERSION KT [FRONT]	2001-05	Front	Coil Over Strut	CK-7852	Kit	1
AIR-COIL SPRING CONVERSION KT [REAR]	2001-05	Rear	Coil Over Strut	CK-7853	Kit	1
COMPRESSOR - DRYER	2001-05			CD-7732	Each	1
CONTROL VALVE	2001-05			CV-0004	Each	1
STRUT - FRONT	2001-05	Front		SH-2000	Each	2
STRUT - REAR LEFT	2001-05	Rear Left		SH-2001	Each	1
STRUT - REAR RIGHT	2001-05	Rear Right		SH-2002	Each	1
RS7						
ALL						
AIR COMPRESSOR	2014-18			CD-7748	Each	1
Front	2014-18	Front		HS-8509	Each	1
		Front		HS-8508	Each	1
S6						
ALL						
AIR COMPRESSOR	2013-18			CD-7748	Each	1
	2007-11			CD-7733	Each	1
AIR SPRING-REAR	2007-11	Rear		AS-7027	Each	2
CONTROL VALVE	2013-18			CV-0012	Each	1
	2007-11			CV-0004	Each	1
Front	2013-18	Front		HS-8509	Each	1
		Front		HS-8508	Each	1
S7						
ALL						
CONTROL VALVE	2013-18			CV-0012	Each	1
Front	2013-18	Front		HS-8509	Each	1
		Front		HS-8508	Each	1
S8						
ALL						
CONTROL VALVE	2013-18			CV-0012	Each	1
CONTROL VALVE	2007-10			CV-0004	Each	1
Front	2013-18	Front		HS-8509	Each	1
		Front		HS-8508	Each	1
AUDI SPORTS UTILITY						
Q7						
ALL						
AIR COMPRESSOR	2007-15			CD-7736	Each	1
AIR SPRING-FRONT LEFT	2007-15	Front Left		AS-7043	Each	1
AIR SPRING-FRONT RIGHT	2007-15	Front Right		AS-7044	Each	1
AIR SPRING-REAR LEFT	2016-17	Rear Left		AS-7086	Each	1
	2007-15	Rear Left		AS-7045	Each	1
AIR SPRING-REAR RIGHT	2016-17	Rear Right		AS-7087	Each	1
	2007-15	Rear Right		AS-7046	Each	1
AIR STRUT - FRONT LEFT	2007-15	Front Left		AS-7354	Each	1
AIR STRUT - FRONT RIGHT	2007-15	Front Right		AS-7355	Each	1

Air Spring Suspension

Part Type	Year	Location	Description	Part No.	Std Pack	Qty/Car
AUDI SPORTS UTILITY (continued)						
Q7 (continued)						
ALL						
AIR STRUT - REAR LEFT	2007-15	Rear Left		AS-7356	Each	1
AIR STRUT - REAR RIGHT	2007-15	Rear Right		AS-7357	Each	1
AIR-COIL SPRING CONV KT [FRONT & REAR]	2007-15	Front and Rear	Suspension Light Removal Tool Not Included	CK-7873	Kit	1
CONTROL VALVE	2007-15			CV-0005	Each	1
BENTLEY						
CONTINENTAL						
ALL						
AIR COMPRESSOR	2003-12			CD-7744	Each	1
AIR STRUT - FRONT LEFT	2003-12	Front Left		AS-7367	Each	1
AIR STRUT - FRONT RIGHT	2003-12	Front Right		AS-7366	Each	1
AIR STRUT - REAR LEFT	2003-12	Rear Left		AS-7338	Each	1
AIR STRUT - REAR RIGHT	2003-12	Rear Right		AS-7339	Each	1
MULSANNE						
ALL						
CONTROL VALVE	2011-15			CV-0012	Each	1
BMW PASSENGER CAR						
525I						
ALL						
AIR COMPRESSOR	2001-03			CD-7724	Each	1
AIR SPRING-REAR LEFT	2001-03	Rear Left	Wagon	AS-7012	Each	1
AIR SPRING-REAR RIGHT	2001-03	Rear Right	Wagon	AS-7013	Each	1
528I						
ALL						
AIR COMPRESSOR	1999-00			CD-7724	Each	1
AIR SPRING-REAR LEFT	1999-00	Rear Left	Wagon	AS-7012	Each	1
AIR SPRING-REAR RIGHT	1999-00	Rear Right	Wagon	AS-7013	Each	1
530XI						
ALL						
AIR SPRING-REAR	2006-07	Rear	Wagon	AS-7015	Each	2
535I						
ALL						
AIR COMPRESSOR	2011-16		Sedan	CD-7745	Each	1
	2009-10		Sedan	CD-7745	Each	1
AIR SPRING-REAR	2011-16	Rear	Sedan	AS-7030	Each	2
	2009-10	Rear	Wagon	AS-7015	Each	2
		Rear	Sedan	AS-7030	Each	2
CONTROL VALVE	2011-16		Sedan	CV-0001	Each	1
	2009-10		Sedan	CV-0001	Each	1
				Wagon	CV-0001	Each
535I GT						
ALL						
AIR COMPRESSOR	2010-17			CD-7745	Each	1
AIR SPRING-REAR	2010-17	Rear		AS-7030	Each	2
CONTROL VALVE	2010-17			CV-0001	Each	1
535I GT XDRIVE						
ALL						
AIR COMPRESSOR	2011-17			CD-7745	Each	1
AIR SPRING-REAR	2011-17	Rear		AS-7030	Each	2
CONTROL VALVE	2011-17			CV-0001	Each	1

Air Spring Suspension

Part Type	Year	Location	Description	Part No.	Std Pack	Qty/Car
BMW PASSENGER CAR (continued)						
535I XDRIVE						
ALL						
AIR COMPRESSOR	2011-16			CD-7745	Each	1
	2009-10		Sedan	CD-7745	Each	1
AIR SPRING-REAR	2011-16	Rear		AS-7030	Each	2
	2009-10	Rear	Wagon	AS-7015	Each	2
		Rear	Sedan	AS-7030	Each	2
CONTROL VALVE	2011-16			CV-0001	Each	1
	2009-10			CV-0001	Each	1
535XI						
ALL						
AIR SPRING-REAR	2008	Rear	Wagon	AS-7015	Each	2
540I						
ALL						
AIR COMPRESSOR	1999-03			CD-7724	Each	1
AIR SPRING-REAR LEFT	1999-03	Rear Left	Wagon	AS-7012	Each	1
AIR SPRING-REAR RIGHT	1999-03	Rear Right	Wagon	AS-7013	Each	1
550I						
ALL						
AIR COMPRESSOR	2009-16			CD-7745	Each	1
AIR SPRING-REAR	2009-16	Rear		AS-7030	Each	2
CONTROL VALVE	2009-16			CV-0001	Each	1
550I GT						
ALL						
AIR COMPRESSOR	2010-15			CD-7745	Each	1
AIR SPRING-REAR	2010-15	Rear		AS-7030	Each	2
CONTROL VALVE	2010-15			CV-0001	Each	1
550I XDRIVE						
ALL						
AIR COMPRESSOR	2011-16			CD-7745	Each	1
550I GT XDRIVE						
ALL						
AIR COMPRESSOR	2010-17			CD-7745	Each	1
550I XDRIVE						
ALL						
AIR SPRING-REAR	2011-16	Rear		AS-7030	Each	2
550I GT XDRIVE						
ALL						
AIR SPRING-REAR	2010-17	Rear		AS-7030	Each	2
550I XDRIVE						
ALL						
CONTROL VALVE	2011-16			CV-0001	Each	1
550I GT XDRIVE						
ALL						
CONTROL VALVE	2010-17			CV-0001	Each	1
740I						
ALL						
AIR COMPRESSOR	2013-15			CD-7745	Each	1
	2010-12			CD-7745	Each	1
AIR SPRING-REAR	2010-12	Rear		AS-7095	Each	2
CONTROL VALVE	2013-15			CV-0001	Each	1
	2010-12			CV-0001	Each	1

Air Spring Suspension

Part Type	Year	Location	Description	Part No.	Std Pack	Qty/Car
BMW PASSENGER CAR (continued)						
740LD XDRIVE						
ALL						
AIR COMPRESSOR	2015			CD-7745	Each	1
740LI						
ALL						
AIR COMPRESSOR	2013-15			CD-7745	Each	1
	2011-12			CD-7745	Each	1
AIR SPRING-REAR	2011-12	Rear		AS-7095	Each	2
CONTROL VALVE	2013-15			CV-0001	Each	1
	2011-12			CV-0001	Each	1
740LI XDRIVE						
ALL						
AIR COMPRESSOR	2013-15			CD-7745	Each	1
CONTROL VALVE	2013-15			CV-0001	Each	1
745I						
ALL						
AIR COMPRESSOR	2002-05			CD-7724	Each	1
AIR STRUT - REAR LEFT	2002-05	Rear Left	w/ Electronic Damper Contr	AS-7385	Each	1
		Rear Left	w/o Electronic Suspension	AS-7394	Each	1
AIR STRUT - REAR RIGHT	2002-05	Rear Right	w/ Electronic Damper Contr	AS-7386	Each	1
		Rear Right	w/o Electronic Suspension	AS-7395	Each	1
745LI						
ALL						
AIR COMPRESSOR	2002-05			CD-7724	Each	1
AIR STRUT - REAR LEFT	2002-05	Rear Left	w/ Electronic Damper Contr	AS-7385	Each	1
		Rear Left	w/o Electronic Suspension	AS-7394	Each	1
AIR STRUT - REAR RIGHT	2002-05	Rear Right	w/ Electronic Damper Contr	AS-7386	Each	1
		Rear Right	w/o Electronic Suspension	AS-7395	Each	1
750I						
ALL						
AIR COMPRESSOR	2013-15			CD-7745	Each	1
	2009-12			CD-7745	Each	1
	2006-08			CD-7724	Each	1
AIR SPRING-REAR	2009-12	Rear		AS-7095	Each	2
AIR STRUT - REAR LEFT	2006-08	Rear Left	w/ Electronic Damper Contr	AS-7385	Each	1
		Rear Left	w/o Electronic Suspension	AS-7394	Each	1
AIR STRUT - REAR RIGHT	2006-08	Rear Right	w/ Electronic Damper Contr	AS-7386	Each	1
		Rear Right	w/o Electronic Suspension	AS-7395	Each	1
CONTROL VALVE	2013-15			CV-0001	Each	1
	2009-12			CV-0001	Each	1
750I XDRIVE						
ALL						
AIR COMPRESSOR	2010-15			CD-7745	Each	1
CONTROL VALVE	2010-15			CV-0001	Each	1
750LI						
ALL						
AIR COMPRESSOR	2013-15			CD-7745	Each	1
	2009-12			CD-7745	Each	1
	2006-08			CD-7724	Each	1
AIR SPRING-REAR	2009-12	Rear		AS-7095	Each	2
AIR STRUT - REAR LEFT	2006-08	Rear Left	w/ Electronic Damper Contr	AS-7385	Each	1
		Rear Left	w/o Electronic Suspension	AS-7394	Each	1
AIR STRUT - REAR RIGHT	2006-08	Rear Right	w/ Electronic Damper Contr	AS-7386	Each	1
		Rear Right	w/o Electronic Suspension	AS-7395	Each	1
CONTROL VALVE	2013-15			CV-0001	Each	1
	2009-12			CV-0001	Each	1

Air Spring Suspension

Part Type	Year	Location	Description	Part No.	Std Pack	Qty/Car
BMW PASSENGER CAR (continued)						
750Li XDRIVE						
ALL						
AIR COMPRESSOR	2010-15			CD-7745	Each	1
CONTROL VALVE	2010-15			CV-0001	Each	1
760I						
ALL						
AIR COMPRESSOR	2004-06			CD-7724	Each	1
AIR STRUT - REAR LEFT	2004-06	Rear Left	w/ Electronic Damper Contr	AS-7385	Each	1
		Rear Left	w/o Electronic Suspension	AS-7394	Each	1
AIR STRUT - REAR RIGHT	2004-06	Rear Right	w/ Electronic Damper Contr	AS-7386	Each	1
		Rear Right	w/o Electronic Suspension	AS-7395	Each	1
760Li						
ALL						
AIR COMPRESSOR	2010-15			CD-7745	Each	1
	2003-09			CD-7724	Each	1
AIR STRUT - REAR LEFT	2003-09	Rear Left	w/ Electronic Damper Contr	AS-7385	Each	1
		Rear Left	w/o Electronic Suspension	AS-7394	Each	1
AIR STRUT - REAR RIGHT	2003-09	Rear Right	w/ Electronic Damper Contr	AS-7386	Each	1
		Rear Right	w/o Electronic Suspension	AS-7395	Each	1
CONTROL VALVE	2010-15			CV-0001	Each	1
ACTIVEHYBRID 7						
ALL						
AIR COMPRESSOR	2013-15			CD-7745	Each	1
CONTROL VALVE	2013-15			CV-0001	Each	1
ALPINA B7						
ALL						
AIR COMPRESSOR	2011-15			CD-7745	Each	1
CONTROL VALVE	2011-15			CV-0001	Each	1
ALPINA B7 XDRIVE						
ALL						
AIR COMPRESSOR	2011-15			CD-7745	Each	1
CONTROL VALVE	2011-15			CV-0001	Each	1
ALPINA B7L						
ALL						
AIR COMPRESSOR	2011-15			CD-7745	Each	1
CONTROL VALVE	2011-15			CV-0001	Each	1
ALPINA B7L XDRIVE						
ALL						
AIR COMPRESSOR	2011-15			CD-7745	Each	1
CONTROL VALVE	2011-15			CV-0001	Each	1
BMW SPORT UTILITY						
X5						
ALL						
AIR COMPRESSOR	2007-13			CD-7726	Each	1
	2000-06		w/ Auto Rear Leveling	CD-7724	Each	1
				w/ 4 Wheel Auto Leveling	CD-7725	Each
AIR SPRING-FRONT LEFT	2000-06	Front Left		AS-7028	Each	1
AIR SPRING-FRONT RIGHT	2000-06	Front Right		AS-7029	Each	1
AIR SPRING-REAR	2007-13	Rear	Exc. M Model	AS-7014	Each	2
AIR SPRING-REAR LEFT	2000-06	Rear Left	w/ Auto Rear Leveling Comfort Suspension	AS-7058	Each	1
		Rear Left	w/ Auto Rear Leveling; Spor Suspension	AS-7066	Each	1
AIR SPRING-REAR RIGHT	2000-06	Rear Right	w/ Auto Rear Leveling Comfort Suspension	AS-7059	Each	1
		Rear Right	w/ Auto Rear Leveling; Spor Suspension	AS-7067	Each	1

Air Spring Suspension

Part Type	Year	Location	Description	Part No.	Std Pack	Qty/Car
BMW SPORT UTILITY (continued)						
X5 (continued)						
ALL						
AIR STRUT - FRONT LEFT	2000-06	Front Left	w/ 4 Wheel Auto Leveling	AS-7318	Each	1
AIR STRUT - FRONT RIGHT	2000-06	Front Right	w/ 4 Wheel Auto Leveling	AS-7317	Each	1
AIR-COIL SPRING CONV KT [FRONT & REAR]	2000-06	Front and Rear	Coil Over Strut + Coil Spring and Shocks	CK-7855WS	Kit	1
AIR-COIL SPRING CONVERSION KT [FRONT]	2000-06	Front	w/ 4 Wheel Auto Leveling	CK-7856WS	Kit	1
AIR-COIL SPRING CONVERSION KT [REAR]	2007-13	Rear	Exc. M Model	CK-7858	Kit	1
	2000-06	Rear	Coil Springs plus any necessary adapters	CK-7857	Kit	1
		Rear	Incl. Rear Springs & Shocks	CK-7857WS	Kit	1
CONTROL VALVE	2007-13			CV-0002	Each	1
X6						
ALL						
AIR COMPRESSOR	2008-14			CD-7726	Each	1
AIR SPRING-REAR	2008-14	Rear	Exc. M Model	AS-7014	Each	2
AIR-COIL SPRING CONVERSION KT [REAR]	2008-14	Rear	Exc. M Model	CK-7858	Kit	1
CONTROL VALVE	2008-14			CV-0002	Each	1
BUICK PASSENGER CAR						
ELECTRA						
ALL						
AIR-COIL SPRING CONVERSION KT [FRONT]	1985-90	Front		CK-7632	Kit	1
AIR-COIL SPRING CONVERSION KT [REAR]	1985-90	Rear		CK-7613	Kit	1
LESABRE						
ALL						
AIR-COIL SPRING CONVERSION KT [FRONT]	1986-90	Front		CK-7632	Kit	1
AIR-COIL SPRING CONVERSION KT [REAR]	2000-05	Rear	Passive Air System; Exc. Magna-Ride Control Suspension	CK-7615	Kit	1
		Rear	Coil Over Shock; Exc. Magna-Ride Suspension	CK-7616	Kit	1
	1996-99	Rear		CK-7613	Kit	1
COMPRESSOR - DRYER	2000-05			CD-7714	Each	1
	1996-99			CD-7720	Each	1
	1991-95			CD-7719	Each	1
DRYER	2000-05			DR-7909	Each	1
	1996-99			DR-7908	Each	1
	1991-95			DR-7908	Each	1
LUCERNE						
ALL						
AIR-COIL SPRING CONVERSION KT [REAR]	2006-11	Rear	Passive Air System; Exc. Magna-Ride Control Suspension	CK-7615	Kit	1
		Rear	Coil Over Shock; Exc. Magna-Ride Suspension	CK-7616	Kit	1
COMPRESSOR - DRYER	2006-11			CD-7718	Each	1
DRYER	2006-11			DR-7909	Each	1
PARK AVENUE						
ALL						
AIR-COIL SPRING CONVERSION KT [REAR]	1997-05	Rear	Passive Air System; Exc. Magna-Ride Control Suspension	CK-7615	Kit	1

Air Spring Suspension

Part Type	Year	Location	Description	Part No.	Std Pack	Qty/Car
BUICK PASSENGER CAR (continued)						
PARK AVENUE (continued)						
ALL						
AIR-COIL SPRING CONVERSION KT [REAR]	1997-05	Rear	Coil Over Shock; Exc. Magn Ride Suspension	CK-7616	Kit	1
	1996	Rear		CK-7613	Kit	1
	1991-95	Rear		CK-7613	Kit	1
COMPRESSOR - DRYER	1997-05			CD-7714	Each	1
	1996			CD-7720	Each	1
	1991-95			CD-7719	Each	1
DRYER	1997-05			DR-7909	Each	1
	1996			DR-7908	Each	1
	1991-95			DR-7908	Each	1
REATTA						
ALL						
AIR-COIL SPRING CONVERSION KT [FRONT]	1989-91	Front		CK-7633	Kit	1
RIVIERA						
ALL						
AIR-COIL SPRING CONVERSION KT [FRONT]	1990-93	Front		CK-7633	Kit	1
AIR-COIL SPRING CONVERSION KT [REAR]	1997-99	Rear	Passive Air System; Exc. Magna-Ride Control Suspension	CK-7615	Kit	1
		Rear	Coil Over Shock; Exc. Magn Ride Suspension	CK-7616	Kit	1
	1995-96	Rear	Passive Air System; Exc. Magna-Ride Control Suspension	CK-7615	Kit	1
		Rear	Coil Over Shock; Exc. Magn Ride Suspension	CK-7616	Kit	1
COMPRESSOR - DRYER	1997-99			CD-7714	Each	1
DRYER	1997-99			DR-7909	Each	1
	1995-96			DR-7909	Each	1
ROADMASTER						
ALL						
DRYER	1995-96			DR-7908	Each	1
BUICK SPORT UTILITY						
RAINIER						
ALL						
AIR SPRING-REAR	2004-07	Rear		AS-7056	Each	2
AIR-COIL SPRING CONVERSION KT [REAR]	2004-07	Rear	Springs & Adapters	CK-7626	Kit	1
		Rear	Incl. Rear Springs & Shocks	CK-7626WS	Kit	1
BUICK VAN						
TERRAZA						
ALL						
AIR SHOCK - REAR	2005-07	Rear		AS-7404	Each	2
COMPRESSOR - DRYER	2005-07			CD-7712	Each	1
CADILLAC PASSENGER CAR						
60 SPECIAL						
ALL						
AIR-COIL SPRING CONV KT [FRONT & REAR]	1993	Front and Rear	FWD; Passive Air System-Relay Kit RK-7560 Required	CK-7622	Kit	1
AIR-COIL SPRING CONVERSION KT [FRONT]	1993	Front	Exc Elec Adj Suspension	CK-7625	Kit	1

Air Spring Suspension

Part Type	Year	Location	Description	Part No.	Std Pack	Qty/Car
CADILLAC PASSENGER CAR (continued)						
60 SPECIAL (continued)						
ALL						
AIR-COIL SPRING CONVERSION KT [REAR]	1993	Rear	FWD; Coil Over Shock	CK-7613	Kit	1
		Rear	FWD; Passive Air System-Relay Kit RK-7560 Required	CK-7614	Kit	1
RELAY KIT	1993		FWD	RK-7560	Kit	1
ALLANTE						
ALL						
AIR-COIL SPRING CONVERSION KT [FRONT]	1989-92	Front	Relay Kit RK-7560 Required	CK-7633	Kit	1
AIR-COIL SPRING CONVERSION KT [REAR]	1993	Rear	Passive Air System	CK-7608	Kit	1
	1989-92	Rear	Hydraulic Units; Relay Kit Required.	CK-7611	Kit	1
		Rear	Passive Air System, Relay K Required	CK-7612	Kit	1
RELAY KIT	1989-92			RK-7560	Kit	1
BROUGHAM						
ALL						
AIR-COIL SPRING CONVERSION KT [REAR]	1991-92	Rear	Passive Air System	CK-7621	Kit	1
	1987-90	Rear	Passive Air System	CK-7620	Kit	1
CTS						
ALL						
AIR SHOCK - REAR	2009-15	Rear		AS-7410	Each	2
COMPRESSOR - DRYER	2008-09			CD-7752	Each	1
CATERA						
ALL						
AIR-COIL SPRING CONVERSION KT [REAR]	1997-01	Rear	Passive Air System	CK-7623	Kit	1
COMMERCIAL CHASSIS						
ALL						
AIR-COIL SPRING CONV KT [FRONT & REAR]	1992-93	Front and Rear	FWD; Passive Air System-Relay Kit RK-7560 Required	CK-7622	Kit	1
	1991	Front and Rear	FWD; Passive Air System-Relay Kit RK-7560 Required	CK-7622	Kit	1
AIR-COIL SPRING CONVERSION KT [FRONT]	1992-93	Front	Exc Elec Adj Suspension	CK-7625	Kit	1
	1991	Front	Exc Elec Adj Suspension	CK-7625	Kit	1
	1985-90	Front	FWD; Relay Kit RK-7560 Required	CK-7632	Kit	1
AIR-COIL SPRING CONVERSION KT [REAR]	1994-96	Rear	RWD; Passive Air System	CK-7621	Kit	1
	1992-93	Rear	FWD; Coil Over Shock	CK-7613	Kit	1
		Rear	FWD; Passive Air System-Relay Kit RK-7560 Required	CK-7614	Kit	1
		Rear	Brougham; RWD; Passive A System	CK-7621	Kit	1
	1991	Rear	FWD; Coil Over Shock	CK-7613	Kit	1
		Rear	FWD; Passive Air System-Relay Kit RK-7560 Required	CK-7614	Kit	1
	1985-90	Rear	FWD; Coil Over Shock	CK-7613	Kit	1

Air Spring Suspension

Part Type	Year	Location	Description	Part No.	Std Pack	Qty/Car
CADILLAC PASSENGER CAR (continued)						
COMMERCIAL CHASSIS (continued)						
ALL						
AIR-COIL SPRING CONVERSION KT [REAR]	1985-90	Rear	FWD; Passive Air System-Relay Kit RK-7560 Required	CK-7614	Kit	1
RELAY KIT	1992-93		FWD	RK-7560	Kit	1
	1991		FWD	RK-7560	Kit	1
	1985-90		FWD	RK-7560	Kit	1
DTS						
ALL						
AIR SPRING-REAR LEFT	2006-11	Rear Left	Limousine Package	AS-7342	Each	1
AIR SPRING-REAR RIGHT	2006-11	Rear Right	Limousine Package	AS-7343	Each	1
AIR-COIL SPRING CONVERSION KT [REAR]	2006-11	Rear	Passive Air System; Exc. Magna-Ride Control Suspension	CK-7615	Kit	1
		Rear	Coil Over Shock; Exc. Magn Ride Suspension	CK-7616	Kit	1
COMPRESSOR - DRYER	2006-11		Sedan	CD-7718	Each	1
			Limousine Package	CD-7738	Each	1
DRYER	2006-11			DR-7909	Each	1
DEVILLE						
ALL						
AIR-COIL SPRING CONVERSION KT [FRONT]	2000-05	Front	w/ Springs	CK-7634	Kit	1
	1999	Front	w/o Springs	CK-7617	Kit	1
		Front	w/ Springs	CK-7636	Kit	1
	1997-98	Front	w/o Springs	CK-7617	Kit	1
		Front	w/ Springs	CK-7636	Kit	1
	1994-95	Front	Relay Kit Required	CK-7633	Kit	1
	1991-93	Front	Exc Elec Adj Suspension	CK-7625	Kit	1
1985-90	Front	FWD; Relay Kit RK-7560 Required	CK-7632	Kit	1	
AIR-COIL SPRING CONVERSION KT [REAR]	2000-05	Rear	Passive Air System; Exc. Magna-Ride Control Suspension	CK-7615	Kit	1
		Rear	Coil Over Shock; Exc. Magn Ride Suspension	CK-7616	Kit	1
	1999	Rear	Passive Air System	CK-7609	Kit	1
		Rear	Coil Over Shock	CK-7624	Kit	1
	1997-98	Rear	Passive Air System	CK-7609	Kit	1
		Rear	Coil Over Shock	CK-7610	Kit	1
	1996	Rear	Passive Air System	CK-7609	Kit	1
		Rear	Coil Over Shock	CK-7610	Kit	1
	1994-95	Rear	Passive Air System, Relay K Required	CK-7608	Kit	1
		Rear	Coil Over Shock, Relay Kit Required	CK-7610	Kit	1
	1991-93	Rear		CK-7613	Kit	1
1985-90	Rear		CK-7613	Kit	1	
COMPRESSOR - DRYER	2000-05			CD-7714	Each	1
	1999		exc. Heavy Duty Susp.	CD-7717	Each	1
	1997-98		exc. Heavy Duty Susp.	CD-7717	Each	1
	1996			CD-7717	Each	1
	1994-95			CD-7717	Each	1
	1991-93			CD-7719	Each	1
	1985-90			CD-7719	Each	1
DRYER	2000-05			DR-7909	Each	1
	1999			DR-7909	Each	1
	1997-98			DR-7909	Each	1

Air Spring Suspension

Part Type	Year	Location	Description	Part No.	Std Pack	Qty/Car
CADILLAC PASSENGER CAR (continued)						
DEVILLE (continued)						
ALL						
DRYER	1996			DR-7909	Each	1
	1994-95			DR-7909	Each	1
	1991-93			DR-7908	Each	1
	1985-90			DR-7908	Each	1
RELAY KIT	1994-95			RK-7560	Kit	1
ELDORADO						
ALL						
AIR-COIL SPRING CONVERSION KT [FRONT]	2001-02	Front	w/o Springs	CK-7617	Kit	1
		Front	w/ Springs	CK-7636	Kit	1
	1999-00	Front	w/o Springs	CK-7617	Kit	1
		Front	w/ Springs	CK-7636	Kit	1
	1997-98	Front	w/o Springs	CK-7617	Kit	1
		Front	w/ Springs	CK-7636	Kit	1
	1994-96	Front	w/ Springs	CK-7633	Kit	1
	1993	Front	Relay Kit Required	CK-7633	Kit	1
1990-92	Front	Relay Kit Required	CK-7633	Kit	1	
AIR-COIL SPRING CONVERSION KT [REAR]	2001-02	Rear	Coil Over Shock	CK-7610	Kit	1
		Rear	Passive Air System	CK-7615	Kit	1
	1999-00	Rear	Coil Over Shock	CK-7610	Kit	1
		Rear	Passive Air System	CK-7615	Kit	1
	1997-98	Rear	Passive Air System	CK-7609	Kit	1
		Rear	Coil Over Shock	CK-7610	Kit	1
	1994-96	Rear	Passive Air System	CK-7609	Kit	1
		Rear	Coil Over Shock	CK-7610	Kit	1
	1993	Rear	Passive Air System, Relay K Required	CK-7608	Kit	1
	1990-92	Rear	Hydraulic Units; Relay Kit Required.	CK-7611	Kit	1
Rear		Passive Air System, Relay K Required	CK-7612	Kit	1	
COMPRESSOR - DRYER	2001-02			CD-7717	Each	1
	1999-00			CD-7717	Each	1
	1997-98			CD-7717	Each	1
	1994-96			CD-7717	Each	1
	1993			CD-7717	Each	1
DRYER	2001-02			DR-7909	Each	1
	1999-00			DR-7909	Each	1
	1997-98			DR-7909	Each	1
	1994-96			DR-7909	Each	1
	1993			DR-7909	Each	1
RELAY KIT	1993			RK-7560	Kit	1
	1990-92			RK-7560	Kit	1
ETC						
AIR-COIL SPRING CONVERSION KT [FRONT]	1999-00	Front	w/o Springs	CK-7617	Kit	1
		Front	w/ Springs	CK-7636	Kit	1
	1997-98	Front		CK-7617	Kit	1
AIR-COIL SPRING CONVERSION KT [REAR]	1999-00	Rear	Passive Air System	CK-7609	Kit	1
		Rear	Coil Over Shock	CK-7610	Kit	1
	1997-98	Rear	Passive Air System	CK-7609	Kit	1
		Rear	Coil Over Shock	CK-7610	Kit	1

Air Spring Suspension

Part Type	Year	Location	Description	Part No.	Std Pack	Qty/Car
CADILLAC PASSENGER CAR (continued)						
FLEETWOOD						
ALL						
AIR-COIL SPRING CONV KT [FRONT & REAR]	1991-92	Front and Rear	Passive Air System-Relay Ki RK-7560 Required	CK-7622	Kit	1
AIR-COIL SPRING CONVERSION KT [FRONT]	1991-92	Front	Exc Elec Adj Suspension	CK-7625	Kit	1
	1988-90	Front	FWD; Relay Kit RK-7560 Required	CK-7632	Kit	1
	1987	Front	FWD; Relay Kit RK-7560 Required	CK-7632	Kit	1
	1986	Front	FWD; Relay Kit RK-7560 Required	CK-7632	Kit	1
	1985	Front	FWD; Relay Kit RK-7560 Required	CK-7632	Kit	1
AIR-COIL SPRING CONVERSION KT [REAR]	1993-96	Rear	RWD; Passive Air System	CK-7621	Kit	1
	1991-92	Rear	Coil Over Shock	CK-7613	Kit	1
		Rear	Passive Air System-Relay Ki RK-7560 Required	CK-7614	Kit	1
	1988-90	Rear	FWD; Coil Over Shock	CK-7613	Kit	1
		Rear	FWD; Passive Air System-Relay Kit RK-7560 Required	CK-7614	Kit	1
	1987	Rear	FWD; Coil Over Shock	CK-7613	Kit	1
		Rear	FWD; Passive Air System-Relay Kit RK-7560 Required	CK-7614	Kit	1
	1986	Rear	FWD; Coil Over Shock	CK-7613	Kit	1
		Rear	FWD; Passive Air System-Relay Kit RK-7560 Required	CK-7614	Kit	1
		Rear	Brougham, Brougham d'Elegance; RWD; Passive System	CK-7620	Kit	1
	1985	Rear	FWD; Coil Over Shock	CK-7613	Kit	1
		Rear	FWD; Passive Air System-Relay Kit RK-7560 Required	CK-7614	Kit	1
		Rear	Brougham, Brougham d'Elegance; RWD; Passive System	CK-7620	Kit	1
COMPRESSOR - DRYER	1991-92			CD-7719	Each	1
	1988-90			CD-7719	Each	1
	1987			CD-7719	Each	1
	1986		FWD	CD-7719	Each	1
	1985		FWD	CD-7719	Each	1
DRYER	1993-96			DR-7908	Each	1
	1991-92			DR-7908	Each	1
	1988-90			DR-7908	Each	1
	1987			DR-7908	Each	1
	1986			DR-7908	Each	1
1985			DR-7908	Each	1	
RELAY KIT	1991-92		FWD	RK-7560	Kit	1
	1988-90		FWD	RK-7560	Kit	1
	1987		FWD	RK-7560	Kit	1
	1986		FWD	RK-7560	Kit	1
	1985		FWD	RK-7560	Kit	1

Air Spring Suspension

Part Type	Year	Location	Description	Part No.	Std Pack	Qty/Car
CADILLAC PASSENGER CAR (continued)						
SEVILLE						
ALL						
AIR-COIL SPRING CONVERSION KT [FRONT]	1998-04	Front	w/o Magnetic Ride Control Suspension	CK-7635	Kit	1
	1997	Front	w/o Springs	CK-7617	Kit	1
		Front	w/ Springs	CK-7636	Kit	1
	1994-96	Front	Relay Kit Required	CK-7633	Kit	1
	1993	Front	Relay Kit Required	CK-7633	Kit	1
1991-92	Front	Relay Kit Required	CK-7633	Kit	1	
AIR-COIL SPRING CONVERSION KT [REAR]	1998-04	Rear	Passive Air System; Exc. Magna-Ride Control Suspension	CK-7615	Kit	1
		Rear	Coil Over Shock; Exc. Magn Ride Suspension	CK-7616	Kit	1
	1997	Rear	Passive Air System	CK-7609	Kit	1
		Rear	Coil Over Shock	CK-7610	Kit	1
	1994-96	Rear	Passive Air System	CK-7609	Kit	1
		Rear	Coil Over Shock	CK-7610	Kit	1
	1993	Rear	Passive Air System, Relay K Required	CK-7608	Kit	1
	1991-92	Rear	Hydraulic Units; Relay Kit Required.	CK-7611	Kit	1
		Rear	Passive Air System, Relay K Required	CK-7612	Kit	1
	1986-90	Rear	Hydraulic Units; Relay Kit Required.	CK-7611	Kit	1
Rear		Passive Air System, Relay K Required	CK-7612	Kit	1	
COMPRESSOR - DRYER	1998-04			CD-7714	Each	1
	1997			CD-7717	Each	1
	1994-96			CD-7717	Each	1
	1993			CD-7717	Each	1
DRYER	1998-04			DR-7909	Each	1
	1997			DR-7909	Each	1
	1994-96			DR-7909	Each	1
	1993			DR-7909	Each	1
RELAY KIT	1993			RK-7560	Kit	1
	1991-92			RK-7560	Kit	1
	1986-90			RK-7560	Kit	1
STS						
ALL						
AIR COMPRESSOR	2005-11			CD-7752	Each	1
AIR SHOCK - REAR	2005-11	Rear		AS-7410	Each	2
XTS						
ALL						
AIR SPRING-REAR	2013-19	Rear		AS-7077	Each	2
CADILLAC SPORT UTILITY						
SRX						
ALL						
AIR COMPRESSOR	2004-09			CD-7752	Each	1
AIR SHOCK - REAR	2004-09	Rear	w/ Sport Suspension	AS-7410	Each	2
ESCALADE						
ALL						
AIR COMPRESSOR	2015-19			CD-7760	Each	1
	2007-14			CD-7713	Each	1
	2002-06			CD-7713	Each	1
AIR SHOCK - REAR	2015-19	Rear	Exc. Magnaride Susp.	AS-7408	Each	2
	2007-14	Rear	Electronic Adjustable Unit	AS-7405	Each	1

Air Spring Suspension

Part Type	Year	Location	Description	Part No.	Std Pack	Qty/Car
CADILLAC SPORT UTILITY (continued)						
ESCALADE (continued)						
ALL						
AIR SHOCK - REAR	2007-14	Rear	Passive Air System	AS-7406	Each	2
	2002-06	Rear	Electronic Adjustable Unit	AS-7405	Each	1
		Rear	Passive Air System	AS-7406	Each	2
AIR-COIL SPRING CONV KT [FRONT & REAR]	2007-14	Front and Rear	Incl. Front Coil Over Struts Rear Passive Air Shocks	CK-7628	Kit	1
	2002-06	Front and Rear	Incl. Front Hydraulic Shocks Rear Air Shocks	CK-7627	Kit	1
AIR-COIL SPRING CONVERSION KT [FRONT]	2007-14	Front		CK-7639	Each	1
AIR-COIL SPRING CONVERSION KT [REAR]	2007-14	Rear	Passive Air Shock	CK-7640	Each	1
	1999-00	Rear	Air Shocks	CK-7619	Kit	1
DRYER	2007-14			DR-7912	Each	1
	2002-06			DR-7912	Each	1
SHOCK ABSORBER - FRONT	2002-06	Front	Converts Electronic Ride to Non-Electronic	AS-7407	Each	2
STRUT - FRONT	2015-19	Front	OEM (Electronic) Style; Bar	AS-7203	Each	2
		Front	OEM (Electronic) Style Complete Unit	AS-7203WS	KIT	2
	2007-14	Front	Aftermaket Design; Bare	SH-2004	Each	2
ESCALADE ESV						
ALL						
AIR COMPRESSOR	2015-19			CD-7760	Each	1
AIR SHOCK - REAR	2015-19	Rear	Exc. Magnaride Susp.	AS-7408	Each	2
	2007-14	Rear	Electronic Adjustable Unit	AS-7405	Each	1
		Rear	Passive Air System	AS-7406	Each	2
	2003-06	Rear	Electronic Adjustable Unit	AS-7405	Each	1
		Rear	Passive Air System	AS-7406	Each	2
AIR-COIL SPRING CONV KT [FRONT & REAR]	2007-14	Front and Rear	Incl. Front Coil Over Struts Rear Passive Air Shocks	CK-7628	Kit	1
	2003-06	Front and Rear	Incl. Front Hydraulic Shocks Rear Air Shocks	CK-7627	Kit	1
AIR-COIL SPRING CONVERSION KT [FRONT]	2007-14	Front		CK-7639	Each	1
AIR-COIL SPRING CONVERSION KT [REAR]	2007-14	Rear	Passive Air Shock	CK-7640	Each	1
COMPRESSOR - DRYER	2007-14			CD-7713	Each	1
	2003-06			CD-7713	Each	1
DRYER	2007-14			DR-7912	Each	1
	2003-06			DR-7912	Each	1
SHOCK ABSORBER - FRONT	2003-06	Front	Converts Electronic Ride to Non-Electronic	AS-7407	Each	2
STRUT - FRONT	2015-19	Front	OEM (Electronic) Style; Bar	AS-7203	Each	2
		Front	OEM (Electronic) Style Complete Unit	AS-7203WS	KIT	2
	2007-14	Front	Aftermaket Design; Bare	SH-2004	Each	2
ESCALADE EXT						
ALL						
AIR SHOCK - REAR	2007-13	Rear	Electronic Adjustable Unit	AS-7405	Each	1
		Rear	Passive Air System	AS-7406	Each	2
	2003-06	Rear	Electronic Adjustable Unit	AS-7405	Each	1
		Rear	Passive Air System	AS-7406	Each	2
AIR-COIL SPRING CONV KT [FRONT & REAR]	2007-13	Front and Rear	Incl. Front Coil Over Struts Rear Passive Air Shocks	CK-7628	Kit	1
	2003-06	Front and Rear	Incl. Front Hydraulic Shocks Rear Air Shocks	CK-7627	Kit	1
AIR-COIL SPRING CONVERSION KT [FRONT]	2007-13	Front		CK-7639	Each	1

Air Spring Suspension

Part Type	Year	Location	Description	Part No.	Std Pack	Qty/Car
CADILLAC SPORT UTILITY (continued)						
ESCALADE EXT (continued)						
ALL						
AIR-COIL SPRING CONVERSION KT [REAR]	2007-13	Rear	Passive Air Shock	CK-7640	Each	1
COMPRESSOR - DRYER	2007-13			CD-7713	Each	1
	2003-06			CD-7713	Each	1
DRYER	2007-13			DR-7912	Each	1
	2003-06			DR-7912	Each	1
SHOCK ABSORBER - FRONT	2003-06	Front	Converts Electronic Ride to Non-Electronic	AS-7407	Each	2
STRUT - FRONT	2007-13	Front	Aftermarket Design; Bare	SH-2004	Each	2
CHEVROLET PASSENGER CAR						
CAPRICE						
ALL						
DRYER	1995-96			DR-7908	Each	1
CHEVROLET SPORT UTILITY						
AVALANCHE						
ALL						
AIR SHOCK - REAR	2007-13	Rear	Electronic Adjustable Unit	AS-7405	Each	1
		Rear	Passive Air System	AS-7406	Each	2
AIR-COIL SPRING CONV KT [FRONT & REAR]	2007-13	Front and Rear	Incl. Front Coil Over Struts Rear Passive Air Shocks	CK-7628	Kit	1
AIR-COIL SPRING CONVERSION KT [FRONT]	2007-13	Front		CK-7639	Each	1
AIR-COIL SPRING CONVERSION KT [REAR]	2007-13	Rear	Passive Air Shock	CK-7640	Each	1
COMPRESSOR - DRYER	2007-13			CD-7713	Each	1
DRYER	2007-13			DR-7912	Each	1
STRUT - FRONT	2007-13	Front	Aftermarket Design; Bare	SH-2004	Each	2
AVALANCHE 1500						
ALL						
AIR SHOCK - REAR	2002-06	Rear	Electronic Adjustable Unit	AS-7405	Each	1
		Rear	Passive Air System	AS-7406	Each	2
AIR-COIL SPRING CONV KT [FRONT & REAR]	2002-06	Front and Rear	Incl. Front Hydraulic Shocks Rear Air Shocks	CK-7627	Kit	1
COMPRESSOR - DRYER	2002-06			CD-7713	Each	1
DRYER	2002-06			DR-7912	Each	1
SHOCK ABSORBER - FRONT	2002-06	Front	Converts Electronic Ride to Non-Electronic	AS-7407	Each	2
SUBURBAN						
ALL						
AIR COMPRESSOR	2015-19			CD-7760	Each	1
AIR SHOCK - REAR	2015-19	Rear	Exc. Magnaride Susp.	AS-7408	Each	2
STRUT - FRONT	2015-19	Front	OEM (Electronic) Style; Bar	AS-7203	Each	2
		Front	OEM (Electronic) Style Complete Unit	AS-7203WS	KIT	2
SUBURBAN 1500						
ALL						
AIR SHOCK - REAR	2007-14	Rear	Electronic Adjustable Unit	AS-7405	Each	1
		Rear	Passive Air System	AS-7406	Each	2
	2000-06	Rear	Electronic Adjustable Unit	AS-7405	Each	1
		Rear	Passive Air System	AS-7406	Each	2
AIR-COIL SPRING CONV KT [FRONT & REAR]	2007-14	Front and Rear	Incl. Front Coil Over Struts Rear Passive Air Shocks	CK-7628	Kit	1
	2000-06	Front and Rear	Incl. Front Hydraulic Shocks Rear Air Shocks	CK-7627	Kit	1
AIR-COIL SPRING CONVERSION KT [FRONT]	2007-14	Front		CK-7639	Each	1

Air Spring Suspension

Part Type	Year	Location	Description	Part No.	Std Pack	Qty/Car
CHEVROLET SPORT UTILITY (continued)						
SUBURBAN 1500 (continued)						
ALL						
AIR-COIL SPRING CONVERSION KT [REAR]	2007-14	Rear	Passive Air Shock	CK-7640	Each	1
COMPRESSOR - DRYER	2007-14			CD-7713	Each	1
	2000-06			CD-7713	Each	1
DRYER	2007-14			DR-7912	Each	1
	2000-06			DR-7912	Each	1
SHOCK ABSORBER - FRONT	2000-06	Front	Converts Electronic Ride to Non-Electronic	AS-7407	Each	2
STRUT - FRONT	2007-14	Front	Aftermaket Design; Bare	SH-2004	Each	2
TAHOE						
ALL						
AIR COMPRESSOR	2015-19			CD-7760	Each	1
AIR SHOCK - REAR	2015-19	Rear	Exc. Magnaride Susp.	AS-7408	Each	2
	2007-14	Rear	Electronic Adjustable Unit	AS-7405	Each	2
		Rear	Passive Air System	AS-7406	Each	2
	2000-06	Rear	Electronic Adjustable Unit	AS-7405	Each	1
		Rear	Passive Air System	AS-7406	Each	2
AIR-COIL SPRING CONV KT [FRONT & REAR]	2007-14	Front and Rear	Incl. Front Coil Over Struts Rear Passive Air Shocks	CK-7628	Kit	1
	2000-06	Front and Rear	Incl. Front Hydraulic Shocks Rear Air Shocks	CK-7627	Kit	1
AIR-COIL SPRING CONVERSION KT [FRONT]	2007-14	Front	Complete Strut (Pair)	CK-7639	Each	1
AIR-COIL SPRING CONVERSION KT [REAR]	2007-14	Rear	Passive Air Shock	CK-7640	Each	1
COMPRESSOR - DRYER	2007-14			CD-7713	Each	1
	2000-06			CD-7713	Each	1
DRYER	2007-14			DR-7912	Each	1
	2000-06			DR-7912	Each	1
SHOCK ABSORBER - FRONT	2000-06	Front	Converts Electronic Ride to Non-Electronic	AS-7407	Each	2
STRUT - FRONT	2015-19	Front	OEM (Electronic) Style; Bar	AS-7203	Each	2
		Front	OEM (Electronic) Style Complete Unit	AS-7203WS	KIT	2
	2007-14	Front	Aftermaket Design; Bare	SH-2004	Each	2
TRAILBLAZER						
113" Wheel Base						
AIR SPRING-REAR	2006-09	Rear		AS-7056	Each	2
	2002-05	Rear		AS-7056	Each	2
AIR-COIL SPRING CONVERSION KT [REAR]	2006-09	Rear		CK-7626	Kit	1
		Rear	Incl. Rear Springs & Shocks	CK-7626WS	Kit	1
	2002-05	Rear		CK-7626	Kit	1
		Rear	Incl. Rear Springs & Shocks	CK-7626WS	Kit	1
129" Wheel Base						
AIR SPRING-REAR	2003-06	Rear		AS-7056	Each	2
AIR-COIL SPRING CONVERSION KT [REAR]	2003-06	Rear		CK-7629	Kit	1
TRAILBLAZER EXT						
129" Wheel Base						
AIR SPRING-REAR	2002-06	Rear		AS-7056	Each	2
AIR-COIL SPRING CONVERSION KT [REAR]	2002-06	Rear		CK-7629	Kit	1

Air Spring Suspension

Part Type	Year	Location	Description	Part No.	Std Pack	Qty/Car
CHEVROLET TRUCK						
SILVERADO 1500						
ALL						
AIR COMPRESSOR	2014-18			CD-7760	Each	1
AIR SHOCK - REAR	2014-18	Rear	Exc. Magnaride Susp.	AS-7408	Each	2
STRUT - FRONT	2014-18	Front	OEM (Electronic) Style; Bar	AS-7203	Each	2
		Front	OEM (Electronic) Style Complete Unit	AS-7203WS	KIT	2
CHEVROLET VAN						
LUMINA APV						
ALL						
AIR-COIL SPRING CONVERSION KT [REAR]	1990-96	Rear		CK-7603	Kit	1
UPLANDER						
ALL						
AIR SHOCK - REAR	2005-09	Rear	w/o Independent Rear Susp.	AS-7404	Each	2
COMPRESSOR - DRYER	2005-09			CD-7712	Each	1
VENTURE						
ALL						
AIR SHOCK - REAR	2004-05	Rear		AS-7404	Each	2
	1997-03	Rear		AS-7404	Each	2
COMPRESSOR - DRYER	2004-05			CD-7712	Each	1
	1997-03			CD-7712	Each	1
CHRYSLER VAN						
TOWN & COUNTRY						
ALL						
AIR-COIL SPRING CONVERSION KT [REAR]	2010-16	Rear	w/ NIVOMAT Rear Suspension	CK-7631	Kit	1
	2008-09	Rear	w/ NIVOMAT Rear Suspension	CK-7630	Kit	1
DODGE VAN						
GRAND CARAVAN						
ALL						
AIR-COIL SPRING CONVERSION KT [REAR]	2010-16	Rear	w/ NIVOMAT Rear Suspension	CK-7631	Kit	1
	2008-09	Rear	w/ NIVOMAT Rear Suspension	CK-7630	Kit	1
FORD PASSENGER CAR						
CROWN VICTORIA						
ALL						
AIR SPRING-REAR	2003-11	Rear		AS-7000	Each	2
	1998-02	Rear		AS-7000	Each	2
	1992-97	Rear		AS-7000	Each	2
AIR SUSPENSION KIT - REAR	2003-11	Rear	Direct Replacement Kit	KT-1100	Kit	1
	1998-02	Rear	Direct Replacement Kit	KT-1100	Kit	1
	1992-97	Rear	Direct Replacement Kit	KT-1100A	Kit	1
AIR-COIL SPRING CONVERSION KT [REAR]	2003-11	Rear	Coil Springs plus any necessary adapters	CK-7800	Kit	1
		Rear	Incl. Rear Springs & Shocks	CK-7841WS	Kit	1
	1998-02	Rear	Coil Springs plus any necessary adapters	CK-7800	Kit	1
		Rear	Incl. Rear Springs & Shocks	CK-7800WS	Kit	1
	1992-97	Rear	Coil Springs plus any necessary adapters	CK-7800	Kit	1
		Rear	Incl. Rear Springs & Shocks	CK-7800WS	Kit	1
COMPRESSOR - DRYER	2003-11			CD-7700	Each	1

Air Spring Suspension

Part Type	Year	Location	Description	Part No.	Std Pack	Qty/Car
FORD PASSENGER CAR (continued)						
CROWN VICTORIA (continued)						
ALL						
COMPRESSOR - DRYER	1998-02			CD-7700	Each	1
	1992-97			CD-7700	Each	1
DRYER	2003-11			DR-7906	Each	1
	1998-02			DR-7906	Each	1
	1992-97			DR-7906	Each	1
O' RING & SEAL KIT	2003-11			OR-7580	Kit	2
	1998-02			OR-7580	Kit	2
	1992-97			OR-7580	Kit	2
SOLENOID - REAR	2003-11	Rear	incl O'Ring Kit	SO-7590	Kit	2
	1998-02	Rear	incl O'Ring Kit	SO-7590	Kit	2
	1992-97	Rear	incl O'Ring Kit	SO-7590	Kit	2
VIBRATION ISOLATOR KIT	2003-11			VI-7550	Kit	1
	1998-02			VI-7550	Kit	1
	1992-97			VI-7550	Kit	1
FORD SPORT UTILITY						
EXPEDITION						
2WD						
AIR SPRING-REAR	1997-02	Rear		AS-7001	Each	2
AIR SUSPENSION KIT - REAR	1997-02	Rear	Direct Replacement Kit	KT-1101	Kit	1
AIR-COIL SPRING CONVERSION KT [REAR]	1997-02	Rear	Coil Springs plus any necessary adapters	CK-7808	Kit	1
		Rear	Incl. Rear Springs & Shocks	CK-7808WS	Kit	1
COMPRESSOR - DRYER	1997-02			CD-7705	Each	1
DRYER	1997-02			DR-7900	Each	1
O' RING & SEAL KIT	1997-02			OR-7580	Kit	2
SOLENOID - REAR	1997-02	Rear	incl O'Ring Kit	SO-7591	Kit	2
VIBRATION ISOLATOR KIT	1997-02			VI-7550	Kit	1
4WD						
AIR SHOCK - FRONT	1997-02	Front		AS-7400	Each	2
AIR SPRING-REAR	1997-02	Rear		AS-7002	Each	2
AIR SUSPENSION KIT - REAR	1997-02	Rear	Direct Replacement Kit	KT-1102	Kit	1
AIR-COIL SPRING CONV KT [FRONT & REAR]	1997-02	Front and Rear	Incl. Coil Springs, Front & Rear Shocks	CK-7862WS	KIT	1
		Front	Coil Over Shock	CK-7815	Kit	1
AIR-COIL SPRING CONVERSION KT [FRONT]	1997-02	Rear	Coil Springs plus any necessary adapters	CK-7809	Kit	1
		Rear	Incl. Rear Springs & Shocks	CK-7809WS	Kit	1
COMPRESSOR - DRYER	1997-02			CD-7705	Each	1
DRYER	1997-02			DR-7900	Each	1
O' RING & SEAL KIT	1997-02			OR-7580	Kit	2
SOLENOID - REAR	1997-02	Rear	incl O'Ring Kit	SO-7591	Kit	2
VIBRATION ISOLATOR KIT	1997-02			VI-7550	Kit	1
ALL						
AIR SPRING-FRONT	2003-06	Front		AS-7051	Each	2
AIR SPRING-REAR	2007-14	Rear		AS-7039	Each	2
	2003-06	Rear		AS-7054	Each	2
AIR STRUT - FRONT	2003-06	Front	Includes Solenoid	AS-7314	Each	2
AIR STRUT - REAR	2003-06	Rear	Includes Solenoid	AS-7315	Each	2
AIR-COIL SPRING CONV KT [FRONT & REAR]	2003-06	Front and Rear	Coil Over Strut	CK-7846	Kit	1
		Front	Coil Over Strut	CK-7816	Kit	1
AIR-COIL SPRING CONVERSION KT [FRONT]	2007-14	Rear	Suspension Light Removal Tool Not Included	CK-7860	Kit	1
		2003-06	Rear	Coil Over Strut	CK-7817	Kit
COMPRESSOR - DRYER	2015-18			CD-7722	Each	1

Air Spring Suspension

Part Type	Year	Location	Description	Part No.	Std Pack	Qty/Car
FORD SPORT UTILITY (continued)						
EXPEDITION (continued)						
ALL						
COMPRESSOR - DRYER	2007-14			CD-7722	Each	1
	2003-06			CD-7705	Each	1
DRYER	2015-18			DR-7910	Each	1
	2007-14			DR-7910	Each	1
	2003-06			DR-7900	Each	1
O' RING & SEAL KIT	2003-06			OR-7580	Kit	4
SOLENOID - FRONT	2003-06	Front	incl O'Ring Kit	SO-7593	Kit	2
SOLENOID - REAR	2007-14	Rear		SO-7594	Each	2
	2003-06	Rear	incl O'Ring Kit	SO-7593	Kit	2
VIBRATION ISOLATOR KIT	2003-06			VI-7550	Kit	1
EXPLORER						
2WD						
AIR-COIL SPRING CONVERSION KT [FRONT]	1995-99	Front		CK-7840	Kit	1
AIR-COIL SPRING CONVERSION KT [REAR]	1995-99	Rear		CK-7819	Kit	1
4WD						
AIR SHOCK - FRONT	1995-98	Front	Non-Electronic Adjust. Unit	AS-7401	Each	2
AIR SHOCK - REAR LEFT	1995-98	Rear Left	Non-Electronic Adjust. Unit	AS-7403	Each	1
AIR SHOCK - REAR RIGHT	1995-98	Rear Right	Non-Electronic Adjust. Unit	AS-7402	Each	1
AIR-COIL SPRING CONVERSION KT [FRONT]	1995-98	Front		CK-7840	Kit	1
AIR-COIL SPRING CONVERSION KT [REAR]	1995-98	Rear	Coil Over Shock	CK-7819	Kit	1
ALL						
AIR-COIL SPRING CONVERSION KT [FRONT]	2000-01	Front		CK-7840	Kit	1
AIR-COIL SPRING CONVERSION KT [REAR]	2000-01	Rear	Coil Over Shock	CK-7819	Kit	1
AWD & 4WD						
AIR SHOCK - FRONT	1999	Front	Non-Electronic Adjust. Unit	AS-7401	Each	2
AIR SHOCK - REAR LEFT	1999	Rear Left	Non-Electronic Adjust. Unit	AS-7403	Each	1
AIR SHOCK - REAR RIGHT	1999	Rear Right	Non-Electronic Adjust. Unit	AS-7402	Each	1
AIR-COIL SPRING CONVERSION KT [FRONT]	1999	Front		CK-7840	Kit	1
AIR-COIL SPRING CONVERSION KT [REAR]	1999	Rear	Coil Over Shock	CK-7819	Kit	1
EXPLORER SPORT TRAC						
ALL						
AIR-COIL SPRING CONVERSION KT [FRONT]	2001-03	Front		CK-7840	Kit	1
AIR-COIL SPRING CONVERSION KT [REAR]	2001-03	Rear	Coil Over Shock	CK-7819	Kit	1
FORD TRUCK						
F-150 PICKUP						
ALL						
AIR SPRING-REAR	2000-04	Rear		AS-7069	Each	2
COMPRESSOR - DRYER	2000-04			CD-7705	Each	1
SOLENOID - REAR	2000-04	Rear		SO-7592	Kit	2
F-250 PICKUP						
ALL						
AIR SPRING-REAR	1997-99	Rear		AS-7069	Each	2

Air Spring Suspension

Part Type	Year	Location	Description	Part No.	Std Pack	Qty/Car
FORD VAN						
WINDSTAR						
ALL						
AIR SPRING-REAR	1999-03	Rear		AS-7068	Each	2
	1995-98	Rear		AS-7068	Each	2
AIR-COIL SPRING CONVERSION KT [REAR]	1999-03	Rear	Coil Springs plus any necessary adapters	CK-7822	Kit	1
	1995-98	Rear	Coil Springs plus any necessary adapters	CK-7811	Kit	1
DRYER	1999-03			DR-7907	Each	1
	1995-98			DR-7907	Each	1
SOLENOID - REAR	1999-03	Rear		SO-7592	Kit	2
	1995-98	Rear		SO-7592	Kit	2
GMC SPORT UTILITY						
ENVOY						
113" Wheel Base						
AIR SPRING-REAR	2002-09	Rear		AS-7056	Each	2
AIR-COIL SPRING CONVERSION KT [REAR]	2002-09	Rear		CK-7626	Kit	1
		Rear	Incl. Rear Springs & Shocks	CK-7626WS	Kit	1
ENVOY XL / XUV						
129" Wheel Base						
AIR SPRING-REAR	2002-06	Rear		AS-7056	Each	2
AIR-COIL SPRING CONVERSION KT [REAR]	2002-06	Rear		CK-7629	Kit	1
YUKON						
ALL						
AIR COMPRESSOR	2015-19			CD-7760	Each	1
AIR SHOCK - REAR	2015-19	Rear	Exc. Magnaride Susp.	AS-7408	Each	2
	2007-14	Rear	Electronic Adjustable Unit	AS-7405	Each	1
		Rear	Passive Air System	AS-7406	Each	2
	2000-06	Rear	Electronic Adjustable Unit	AS-7405	Each	1
		Rear	Passive Air System	AS-7406	Each	2
AIR-COIL SPRING CONV KT [FRONT & REAR]	2007-14	Front and Rear	Incl. Front Coil Over Struts Rear Passive Air Shocks	CK-7628	Kit	1
	2000-06	Front and Rear	Incl. Front Hydraulic Shocks Rear Air Shocks	CK-7627	Kit	1
AIR-COIL SPRING CONVERSION KT [FRONT]	2007-14	Front		CK-7639	Each	1
AIR-COIL SPRING CONVERSION KT [REAR]	2007-14	Rear	Passive Air Shock	CK-7640	Each	1
COMPRESSOR - DRYER	2007-14			CD-7713	Each	1
	2000-06			CD-7713	Each	1
DRYER	2007-14			DR-7912	Each	1
	2000-06			DR-7912	Each	1
SHOCK ABSORBER - FRONT	2000-06	Front	Converts Electronic Ride to Non-Electronic	AS-7407	Each	2
STRUT - FRONT	2015-19	Front	OEM (Electronic) Style; Bar	AS-7203	Each	2
		Front	OEM (Electronic) Style Complete Unit	AS-7203WS	KIT	2
	2007-14	Front	Aftermarket Design; Bare	SH-2004	Each	2
YUKON XL						
ALL						
AIR COMPRESSOR	2015-19			CD-7760	Each	1
AIR SHOCK - REAR	2015-19	Rear	Exc. Magnaride Susp.	AS-7408	Each	2
STRUT - FRONT	2015-19	Front	OEM (Electronic) Style; Bar	AS-7203	Each	2
		Front	OEM (Electronic) Style Complete Unit	AS-7203WS	KIT	2

Air Spring Suspension

Part Type	Year	Location	Description	Part No.	Std Pack	Qty/Car
GMC SPORT UTILITY (continued)						
YUKON XL 1500						
ALL						
AIR SHOCK - REAR	2007-14	Rear	Electronic Adjustable Unit	AS-7405	Each	1
		Rear	Passive Air System	AS-7406	Each	2
	2000-06	Rear	Electronic Adjustable Unit	AS-7405	Each	1
		Rear	Passive Air System	AS-7406	Each	2
AIR-COIL SPRING CONV KT [FRONT & REAR]	2007-14	Front and Rear	Incl. Front Coil Over Struts Rear Passive Air Shocks	CK-7628	Kit	1
	2000-06	Front and Rear	Incl. Front Hydraulic Shocks Rear Air Shocks	CK-7627	Kit	1
AIR-COIL SPRING CONVERSION KT [FRONT]	2007-14	Front		CK-7639	Each	1
AIR-COIL SPRING CONVERSION KT [REAR]	2007-14	Rear	Passive Air Shock	CK-7640	Each	1
COMPRESSOR - DRYER	2007-14			CD-7713	Each	1
	2000-06			CD-7713	Each	1
DRYER	2007-14			DR-7912	Each	1
	2000-06			DR-7912	Each	1
SHOCK ABSORBER - FRONT	2000-06	Front	Converts Electronic Ride to Non-Electronic	AS-7407	Each	2
STRUT - FRONT	2007-14	Front	Aftermarket Design; Bare	SH-2004	Each	2
GMC TRUCK						
SIERRA 1500						
ALL						
AIR COMPRESSOR	2014-18			CD-7760	Each	1
AIR SHOCK - REAR	2014-18	Rear	Exc. Magnaride Susp.	AS-7408	Each	2
STRUT - FRONT	2014-18	Front	OEM (Electronic) Style; Bar	AS-7203	Each	2
		Front	OEM (Electronic) Style Complete Unit	AS-7203WS	KIT	2
HUMMER						
H2						
ALL						
AIR SPRING-REAR	2008-09	Rear		AS-7055	Each	2
		Rear	Incl. (2) Air Springs & (2) Shocks	AS-7055WS	Kit	1
	2005-07	Rear		AS-7055	Each	2
		Rear	Incl. (2) Air Springs & (2) Shocks	AS-7055WS	Kit	1
	2003-04	Rear		AS-7055	Each	2
		Rear	Incl. (2) Air Springs & (2) Shocks	AS-7055WS	Kit	1
AIR SUSPENSION KIT - FRON & REAR	2008-09	Front and Rear	Complete Service Kit	KT-1107	Kit	1
	2005-07	Front and Rear	Complete Service Kit	KT-1107	Kit	1
	2003-04	Front and Rear	Complete Service Kit	KT-1107	Kit	1
AIR-COIL SPRING CONVERSION KT [REAR]	2008-09	Rear	Springs & Adapters	CK-7839	Kit	1
		Rear	Incl. Rear Springs & Shocks	CK-7839WS	Kit	1
		Rear	Incl. Coil Springs, Front & Rear Shocks	KT-1108	Kit	1
	2005-07	Rear	Springs & Adapters	CK-7839	Kit	1
		Rear	Incl. Rear Springs & Shocks	CK-7839WS	Kit	1
		Rear	Incl. Coil Springs, Front & Rear Shocks	KT-1108	Kit	1
	2003-04	Rear	Springs & Adapters	CK-7839	Kit	1
		Rear	Incl. Rear Springs & Shocks	CK-7839WS	Kit	1
		Rear	Incl. Coil Springs, Front & Rear Shocks	KT-1108	Kit	1

Air Spring Suspension

Part Type	Year	Location	Description	Part No.	Std Pack	Qty/Car
HUMMER (continued)						
H2 (continued)						
ALL						
COMPRESSOR - DRYER	2008-09			CD-7740	Each	1
	2005-07			CD-7739	Each	1
	2003-04		Purchase of GM hose #15925802 & 25903601 is required for proper fit.	CD-7739	Each	1
INFINITI SPORT UTILITY						
QX56						
ALL						
AIR COMPRESSOR	2004-13			CD-7763	Each	1
INTERNATIONAL MEDIUM/HEAVY DUTY TRUCK						
PROSTAR						
ALL						
CAB AIR SHOCK	2008-17			AS-7906	Each	2
ISUZU SPORT UTILITY						
ASCENDER						
ALL						
AIR SPRING-REAR	2003-07	Rear		AS-7056	Each	2
AIR-COIL SPRING CONVERSION KT [REAR]	2003-07	Rear	Springs & Adapters	CK-7626	Kit	1
		Rear	Incl. Rear Springs & Shocks	CK-7626WS	Kit	1
JAGUAR						
SUPER V8						
ALL						
AIR-COIL SPRING CONV KT [FRONT & REAR]	2005-09	AIR-COIL SPRI CONV KT [FRONT & REA		CK-7867	Kit	1
VANDEN PLAS						
ALL						
AIR COMPRESSOR	2008-09			CD-7743	Each	1
	2004-07			CD-7743	Each	1
AIR STRUT - FRONT	2008-09	Front	w/ Comfort Suspension	AS-7368	Each	2
	2004-07	Front	w/ Comfort Suspension	AS-7368	Each	2
AIR STRUT - REAR	2008-09	Rear	w/ Comfort Suspension	AS-7369	Each	2
	2004-07	Rear	w/ Comfort Suspension	AS-7369	Each	2
AIR-COIL SPRING CONV KT [FRONT & REAR]	2004-07	Front and Rear		CK-7867	Kit	1
XJ						
ALL						
CONTROL VALVE	2010-15			CV-0013	Each	1
XJ8						
ALL						
AIR COMPRESSOR	2008-09			CD-7743	Each	1
	2004-07			CD-7743	Each	1
AIR STRUT - FRONT	2008-09	Front	w/ Comfort Suspension	AS-7368	Each	2
	2004-07	Front	w/ Comfort Suspension	AS-7368	Each	2
AIR STRUT - REAR	2008-09	Rear	w/ Comfort Suspension	AS-7369	Each	2
	2004-07	Rear	w/ Comfort Suspension	AS-7369	Each	2
AIR-COIL SPRING CONV KT [FRONT & REAR]	2008-09	Front and Rear		CK-7867	Kit	1
	2004-07	Front and Rear		CK-7867	Kit	1

Air Spring Suspension

Part Type	Year	Location	Description	Part No.	Std Pack	Qty/Car
JAGUAR (continued)						
XJR						
ALL						
AIR COMPRESSOR	2008-09			CD-7743	Each	1
	2004-07			CD-7743	Each	1
AIR STRUT - FRONT	2008-09	Front	w/ Comfort Suspension	AS-7368	Each	2
AIR STRUT - REAR	2008-09	Rear	w/ Comfort Suspension	AS-7369	Each	2
AIR-COIL SPRING CONV KT [FRONT & REAR]	2008-09	Front and Rear		CK-7867	Kit	1
	2004-07	AIR-COIL SPRI CONV KT [FRONT & REA		CK-7867	Kit	1
CONTROL VALVE	2014-15			CV-0013	Each	1
JEEP SPORT UTILITY						
GRAND CHEROKEE						
ALL						
AIR COMPRESSOR	2011-20			CD-7757	Each	1
AIR SPRING-FRONT	2011-20	Front		AS-7078	Each	2
AIR SPRING-REAR	2011-20	Rear		AS-7062	Each	2
AIR STRUT - FRONT LEFT	2011-20	Front Left	w/ Standard Suspension	AS-7370	Each	1
AIR STRUT - FRONT RIGHT	2011-20	Front Right	w/ Standard Suspension	AS-7371	Each	1
CONTROL VALVE	2011-20			CV-0005	Each	1
KIA SPORT UTILITY						
BORREGO						
ALL						
AIR COMPRESSOR	2009-11			CD-7759	Each	1
AIR SPRING-REAR LEFT	2009-11	Rear Left		AS-7088	Each	1
AIR SPRING-REAR RIGHT	2009-11	Rear Right		AS-7089	Each	1
LAND ROVER SPORT UTILITY						
LR3 / DISCOVERY 3						
ALL						
AIR COMPRESSOR	2007-09		Hitachi Style	CD-7741	Each	1
	2005-06		Hitachi Style	CD-7741	Each	1
AIR SPRING-FRONT	2007-09	Front		AS-7018	Each	2
	2005-06	Front		AS-7018	Each	2
AIR SPRING-REAR	2007-09	Rear		AS-7017	Each	2
	2005-06	Rear		AS-7017	Each	2
AIR STRUT - FRONT	2007-09	Front		AS-7328	Each	2
		Front	w/o ACE Suspension; w/o R Stability Option	AS-7347	Each	2
	2005-06	Front		AS-7328	Each	2
AIR-COIL SPRING CONV KT [FRONT & REAR]	2007-09	Front and Rear	Exc. HSE Models	CK-7865	Kit	1
	2005-06	Front and Rear	Exc. HSE Models	CK-7865	Kit	1
CONTROL VALVE - FRONT	2007-09	Front	(Front)	CV-0008	Each	1
	2005-06	Front	(Front)	CV-0008	Each	1
CONTROL VALVE - REAR	2007-09	Rear	(Rear)	CV-0008	Each	1
	2005-06	Rear	(Rear)	CV-0008	Each	1
CONTROL VALVE - RESERVO	2007-09		By Reservoir	CV-0009	Each	1
	2005-06		By Reservoir	CV-0009	Each	1
LR4 / DISCOVERY 4						
ALL						
AIR COMPRESSOR	2013-14		Hitachi Style	CD-7741	Each	1
	2010-12		Hitachi Style	CD-7741	Each	1
AIR SPRING-FRONT	2015-16	Front		AS-7018	Each	2
	2013-14	Front		AS-7018	Each	2
	2010-12	Front		AS-7018	Each	2

Air Spring Suspension

Part Type	Year	Location	Description	Part No.	Std Pack	Qty/Car
LAND ROVER SPORT UTILITY (continued)						
LR4 / DISCOVERY 4 (continued)						
ALL						
AIR SPRING-REAR	2015-16	Rear		AS-7017	Each	2
	2013-14	Rear		AS-7017	Each	2
	2010-12	Rear		AS-7017	Each	2
AIR STRUT - FRONT	2015-16	Front		AS-7328	Each	2
	2013-14	Front		AS-7328	Each	2
	2010-12	Front		AS-7328	Each	2
CONTROL VALVE - FRONT	2015-16	Front	(Front)	CV-0008	Each	1
	2013-14	Front	(Front)	CV-0008	Each	1
	2010-12	Front	(Front)	CV-0008	Each	1
CONTROL VALVE - REAR	2015-16	Rear	(Rear)	CV-0008	Each	1
	2013-14	Rear	(Rear)	CV-0008	Each	1
	2010-12	Rear	(Rear)	CV-0008	Each	1
CONTROL VALVE - RESERVO	2015-16		By Reservoir	CV-0009	Each	1
	2013-14		By Reservoir	CV-0009	Each	1
	2010-12		By Reservoir	CV-0009	Each	1
DISCOVERY						
Series II w/ Rear Air Suspension						
AIR COMPRESSOR	1998-04		AMK Style	CD-7742	Each	1
AIR SPRING-REAR	1998-04	Rear		AS-7020	Each	2
AIR-COIL SPRING CONVERSION KT [REAR]	1998-04	Rear		CK-7810	Kit	1
RANGE ROVER						
ALL						
AIR COMPRESSOR	2006-09			CD-7742	Each	1
	2003-05			CD-7747	Each	1
	1996-02			CD-7737	Each	1
	1995			CD-7737	Each	1
AIR SPRING-FRONT	1996-02	Front	Bellows Only	AS-7024	Each	2
		Front	OEM Design	AS-7032	Each	2
	1995	Front	Bellows Only	AS-7024	Each	2
		Front	OEM Design	AS-7032	Each	2
		Front	Bellows Only	AS-7024	Each	2
		Front	Complete Air Spring and Bellows	AS-7048	Each	2
	1993-94	Front	Bellows Only	AS-7024	Each	2
Front		Complete Air Spring and Bellows	AS-7048	Each	2	
AIR SPRING-FRONT LEFT	2012	Front Left		AS-7073	Each	1
	2010-11	Front Left		AS-7073	Each	1
	2006-09	Front Left		AS-7073	Each	1
	2003-05	Front Left		AS-7073	Each	1
AIR SPRING-FRONT RIGHT	2012	Front Right		AS-7074	Each	1
	2010-11	Front Right		AS-7074	Each	1
	2006-09	Front Right		AS-7074	Each	1
	2003-05	Front Right		AS-7074	Each	1
AIR SPRING-REAR	2013-21	Rear		AS-7094	Each	2
	2012	Rear		AS-7016	Each	2
	2010-11	Rear		AS-7016	Each	2
	2006-09	Rear		AS-7016	Each	2
	2003-05	Rear		AS-7016	Each	2
	1996-02	Rear	Bellows Only	AS-7025	Each	2
		Rear	OEM Design	AS-7033	Each	2
	1995	Rear	Bellows Only	AS-7025	Each	2
		Rear	OEM Design	AS-7033	Each	2
		Rear	Bellows Only	AS-7025	Each	2
Rear		Complete Air Spring and Bellows	AS-7049	Each	2	

Air Spring Suspension

Part Type	Year	Location	Description	Part No.	Std Pack	Qty/Car
LAND ROVER SPORT UTILITY (continued)						
RANGE ROVER (continued)						
ALL						
AIR SPRING-REAR	1993-94	Rear	Bellows Only	AS-7025	Each	2
		Rear	Complete Air Spring and Bellows	AS-7049	Each	2
AIR STRUT - FRONT LEFT	2012	Front Left	Exc. VDS; Exc. Supercharg	AS-7329	Each	1
		Front Left	Exc. VDS; w/ Supercharged	AS-7344	Each	1
	2010-11	Front Left	Exc. VDS; Exc. Supercharg	AS-7329	Each	1
		Front Left	Exc. VDS; w/ Supercharged	AS-7344	Each	1
	2006-09	Front Left	HSE Model	AS-7329	Each	1
		Front Left	Supercharged Model	AS-7344	Each	1
2003-05	Front Left	Left Side	AS-7329	Each	1	
AIR STRUT - FRONT RIGHT	2012	Front Right	Exc. VDS; Exc. Supercharg	AS-7330	Each	1
		Front Right	Exc. VDS; w/ Supercharged	AS-7345	Each	1
	2010-11	Front Right	Exc. VDS; Exc. Supercharg	AS-7330	Each	1
		Front Right	Exc. VDS; w/ Supercharged	AS-7345	Each	1
	2006-09	Front Right	HSE Model	AS-7330	Each	1
		Front Right	Supercharged Model	AS-7345	Each	1
2003-05	Front Right	Right Side	AS-7330	Each	1	
AIR-COIL SPRING CONV KT [FRONT & REAR]	2003-05	Front and Rear		CK-7871	Kit	1
	1996-02	Front and Rear		CK-7848	Kit	1
	1995	Front and Rear		CK-7848	Kit	1
AIR-COIL SPRING CONVERSION KT [FRONT]	1996-02	Front		CK-7827	Kit	1
	1995	Front		CK-7827	Kit	1
		Front		CK-7828	Kit	1
	1993-94	Front		CK-7828	Kit	1
AIR-COIL SPRING CONVERSION KT [REAR]	1996-02	Rear		CK-7837	Kit	1
	1995	Rear		CK-7837	Kit	1
		Rear		CK-7838	Kit	1
	1993-94	Rear		CK-7838	Kit	1
COMPRESSOR - DRYER	2013-21			CD-7756	Each	1
	2012			CD-7742	Each	1
	2010-11			CD-7742	Each	1
DRYER	1996-02			DR-7911	Each	1
	1995			DR-7911	Each	1
SHOCK ABSORBER - REAR	2012	Rear	w/o ADS	SH-1004	Each	2
	2010-11	Rear	w/o ADS	SH-1004	Each	2
	2006-09	Rear	w/o ADS	SH-1004	Each	2
	2003-05	Rear	w/o ADS	SH-1004	Each	2
SHOCK ABSORBER - REAR LEFT	2012	Rear Left	ADS	SH-1005	Each	1
	2010-11	Rear Left	ADS	SH-1005	Each	1
	2006-09	Rear Left	ADS	SH-1005	Each	1
	2003-05	Rear Left	ADS	SH-1005	Each	1
SHOCK ABSORBER - REAR RIGHT	2012	Rear Right	ADS	SH-1006	Each	1
	2010-11	Rear Right	ADS	SH-1006	Each	1
	2006-09	Rear Right	ADS	SH-1006	Each	1
	2003-05	Rear Right	ADS	SH-1006	Each	1
RANGE ROVER SPORT						
ALL						
AIR COMPRESSOR	2010-13			CD-7741	Each	1
	2006-09		Hitachi Style	CD-7741	Each	1
AIR SPRING-FRONT	2010-13	Front		AS-7018	Each	2
	2006-09	Front		AS-7018	Each	2
AIR SPRING-REAR	2014-20	Rear		AS-7090	Each	2
	2006-09	Rear		AS-7017	Each	2

Air Spring Suspension

Part Type	Year	Location	Description	Part No.	Std Pack	Qty/Car
LAND ROVER SPORT UTILITY (continued)						
RANGE ROVER SPORT (continued)						
ALL						
AIR STRUT - FRONT	2010-13	Front	w/o Active Dampening; w/ R Control	AS-7328	Each	2
		Front	w/ Active Dampening System	AS-7391	Each	2
	2006-09	Front	w/o Active Dampening; w/ R Control	AS-7328	Each	2
		Front	w/ ACE Suspension; w/ Roll Stability Option	AS-7346	Each	2
AIR STRUT - REAR	2010-13	Front	w/o ACE Suspension; w/o R Stability Option	AS-7347	Each	2
		Rear	w/o ACE Suspension; w/o R Stability Option	AS-7327	Each	2
	2006-09	Rear	w/o ACE Suspension; w/o R Stability Option	AS-7327	Each	2
Rear		w/ ACE Suspension; w/ Roll Stability Option	AS-7360	Each	2	
COMPRESSOR - DRYER	2014-20			CD-7756	Each	1
CONTROL VALVE - FRONT	2014-20	Front	(Front)	CV-0008	Each	1
	2010-13	Front	(Front)	CV-0008	Each	1
	2006-09	Front	(Front)	CV-0008	Each	1
CONTROL VALVE - REAR	2014-20	Rear	(Rear)	CV-0008	Each	1
	2010-13	Rear	(Rear)	CV-0008	Each	1
	2006-09	Rear	(Rear)	CV-0008	Each	1
CONTROL VALVE - RESERVOIR	2014-20		By Reservoir	CV-0009	Each	1
	2010-13		By Reservoir	CV-0009	Each	1
	2006-09		By Reservoir	CV-0009	Each	1
LEXUS PASSENGER CAR						
LS400						
ALL						
AIR-COIL SPRING CONV KIT [FRONT & REAR]	1990-00	Front and Rear		CK-7861	KIT	1
AIR-COIL SPRING CONVERSION KIT [FRONT]	1990-00	Front		CK-7863	KIT	1
AIR-COIL SPRING CONVERSION KIT [REAR]	1990-00	Rear		CK-7864	KIT	1
LS460						
ALL						
AIR COMPRESSOR	2009-17			CD-7769	EA	1
LS600H						
ALL						
AIR COMPRESSOR	2008-16			CD-7769	EA	1
LS460						
ALL						
AIR COMPRESSOR	2007-08			CD-7769	EA	1
AIR STRUT - FRONT LEFT	2009-17	Front Left	RWD	AS-7376L	Each	1
		Front Left	AWD	AS-7398	Each	1
LS600H						
ALL						
AIR STRUT - FRONT LEFT	2008-16	Front Left		AS-7398	Each	1
LS460						
ALL						
AIR STRUT - FRONT LEFT	2007-08	Front Left	RWD	AS-7376L	Each	1
AIR STRUT - FRONT RIGHT	2009-17	Front Right	RWD	AS-7376R	Each	1
		Front Right	AWD	AS-7399	Each	1

Air Spring Suspension

Part Type	Year	Location	Description	Part No.	Std Pack	Qty/Car
LEXUS PASSENGER CAR (continued)						
LS600H						
ALL						
AIR STRUT - FRONT RIGHT	2008-16	Front Right		AS-7399	Each	1
LS460						
ALL						
AIR STRUT - FRONT RIGHT	2007-08	Front Right	RWD	AS-7376R	Each	1
AIR STRUT - REAR LEFT	2009-17	Rear Left		AS-7377L	Each	1
LS600H						
ALL						
AIR STRUT - REAR LEFT	2008-16	Rear Left		AS-7377L	Each	1
LS460						
ALL						
AIR STRUT - REAR LEFT	2007-08	Rear Left		AS-7377L	Each	1
AIR STRUT - REAR RIGHT	2009-17	Rear Right		AS-7377R	Each	1
LS600H						
ALL						
AIR STRUT - REAR RIGHT	2008-16	Rear Right		AS-7377R	Each	1
LS460						
ALL						
AIR STRUT - REAR RIGHT	2007-08	Rear Right		AS-7377R	Each	1
LEXUS SPORT UTILITY						
GX460						
ALL						
AIR COMPRESSOR	2010-18			CD-7758	Each	1
AIR SPRING-REAR LEFT	2010-18	Rear Left		AS-7075	Each	1
AIR SPRING-REAR RIGHT	2010-18	Rear Right		AS-7076	Each	1
AIR-COIL SPRING CONVERSION KT [REAR]	2010-18	Rear		CK-7866	Kit	1
DRYER	2010-18			DR-7915	Each	1
GX470						
ALL						
ACTIVE TO PASSIVE SUSP CONV KIT - FRONT	2003-09	Front		CK-7869	Each	1
AIR COMPRESSOR	2003-09			CD-7751	Each	1
AIR SPRING-REAR LEFT	2003-09	Rear Left	w/ Rear Air Spring Suspension	AS-7037	Each	1
AIR SPRING-REAR RIGHT	2003-09	Rear Right	w/ Rear Air Spring Suspension	AS-7038	Each	1
AIR-COIL SPRING CONVERSION KT [REAR]	2003-09	Rear		CK-7866	Kit	1
DRYER	2003-09			DR-7914	Each	1
SHOCK ABSORBER - REAR	2003-09	Rear	OEM (Electronic) Style	AS-7204	Each	2
STRUT - FRONT	2003-09	Front	Aftermarket Design	SH-2005	Each	2
RX330						
ALL						
AIR COMPRESSOR	2004-06			CD-7765	Each	1
RX350						
ALL						
AIR COMPRESSOR	2007-09			CD-7765	Each	1
LINCOLN PASSENGER CAR						
CONTINENTAL						
ALL						
AIR SPRING-FRONT	1984-87	Front		AS-7007	Each	2
AIR SPRING-FRONT LEFT	1995-96	Front Left	Air Spring Only	AS-7003L	Each	1

Air Spring Suspension

Part Type	Year	Location	Description	Part No.	Std Pack	Qty/Car
LINCOLN PASSENGER CAR (continued)						
CONTINENTAL (continued)						
ALL						
AIR SPRING-FRONT RIGHT	1995-96	Front Right	Air Spring Only	AS-7003R	Each	1
AIR SPRING-REAR	1984-87	Rear		AS-7006	Each	2
AIR SPRING-REAR LEFT	1997-02	Rear Left		AS-7004	Each	1
	1995-96	Rear Left		AS-7004	Each	1
AIR SPRING-REAR RIGHT	1997-02	Rear Right		AS-7005	Each	1
	1995-96	Rear Right		AS-7005	Each	1
AIR SUSPENSION KIT - FRON & REAR	1984-87	Front and Rear	Direct Replacement Kit	KT-1106	Kit	1
AIR SUSPENSION KIT - REAR	1997-02	Rear	Direct Replacement Kit	KT-1104	Kit	1
	1995-96	Rear	Direct Replacement Kit	KT-1105	Kit	1
AIR-COIL SPRING CONV KT [FRONT & REAR]	1997-02	Front and Rear	Coil Over Strut Front + Rear Coil Springs	CK-7842	Kit	1
		Front and Rear	Coil Over Strut + Coil Spring and Shocks - OEM Passive System	CK-7842WS	Kit	1
	1995-96	Front and Rear	Coil Springs plus any necessary adapters	CK-7859	Kit	1
	1988-94	Front and Rear	Coil Over Strut	CK-7847	Kit	1
	1984-87	Front and Rear	Incl. Coil Over Strut and Re Springs and Shocks	CK-7844WS	Kit	1
AIR-COIL SPRING CONVERSION KT [FRONT]	1997-02	Front	Coil Over Strut - Passive Susp.	CK-7813	Kit	1
	1995-96	Front	Coil Springs Only - use existing struts	CK-7823	Kit	1
	1988-94	Front	Coil Over Strut	CK-7824	Kit	1
	1984-87	Front	Coil Springs plus any necessary adapters	CK-7821	Kit	1
		Front	incl. Front Springs and Shocks	CK-7821WS	Kit	1
AIR-COIL SPRING CONVERSION KT [REAR]	1997-02	Rear	Coil Springs plus any necessary adapters	CK-7803	Kit	1
		Rear	Incl. Rear Springs & Shocks with OEM Passive Suspension Only	CK-7803WS	Kit	1
		Rear	Incl. Rear Springs & Shocks with OEM Electronic System Only	CK-7870WS	Kit	1
	1995-96	Rear	Coil Springs plus any necessary adapters	CK-7803	Kit	1
	1988-94	Rear	Coil Over Strut	CK-7834	Kit	1
	1984-87	Rear	Coil Springs plus any necessary adapters	CK-7831	Kit	1
		Rear	Incl. Rear Springs & Shocks	CK-7831WS	Kit	1
COMPRESSOR - DRYER	1997-02			CD-7702	Each	1
	1995-96			CD-7702	Each	1
	1988-94			CD-7703	Each	1
	1984-87			CD-7704	Each	1
DRYER	1997-02			DR-7906	Each	1
	1995-96			DR-7903	Each	1
	1988-94			DR-7900	Each	1
	1984-87			DR-7900	Each	1
O' RING & SEAL KIT	1997-02			OR-7580	Kit	2
	1995-96			OR-7580	Kit	4
	1988-94			OR-7580	Kit	2
	1984-87			OR-7580	Kit	4
SOLENOID - FRONT	1995-96	Front	incl O'Ring Kit	SO-7590	Kit	2
	1988-94	Front	Left & Right	SO-7590	Kit	2
	1984-87	Front	incl O'Ring Kit	SO-7590	Kit	2

Air Spring Suspension

Part Type	Year	Location	Description	Part No.	Std Pack	Qty/Car
LINCOLN PASSENGER CAR (continued)						
CONTINENTAL (continued)						
ALL						
SOLENOID - REAR	1997-02	Rear	incl O'Ring Kit	SO-7591	Kit	2
	1995-96	Rear	incl O'Ring Kit	SO-7591	Kit	2
	1988-94	Rear		SO-7590	Kit	2
	1984-87	Rear	incl O'Ring Kit	SO-7590	Kit	2
VIBRATION ISOLATOR KIT	1997-02			VI-7550	Kit	1
	1995-96			VI-7550	Kit	1
	1988-94			VI-7550	Kit	1
	1984-87			VI-7550	Kit	1
MARK VII						
ALL						
AIR SPRING-FRONT	1984-92	Front		AS-7007	Each	2
AIR SPRING-REAR	1984-92	Rear		AS-7006	Each	2
AIR SUSPENSION KIT - FRON & REAR	1984-92	Front and Rear	Direct Replacement Kit	KT-1106	Kit	1
AIR-COIL SPRING CONV KT [FRONT & REAR]	1984-92	Front and Rear	Incl. Coil Over Strut and Re Springs and Shocks	CK-7844WS	Kit	1
AIR-COIL SPRING CONVERSION KT [FRONT]	1984-92	Front	Springs & Adapters	CK-7821	Kit	1
		Front	incl. Front Springs and Shocks	CK-7821WS	Kit	1
AIR-COIL SPRING CONVERSION KT [REAR]	1984-92	Rear	Springs & Adapters	CK-7831	Kit	1
		Rear	Incl. Rear Springs & Shocks	CK-7831WS	Kit	1
COMPRESSOR - DRYER	1984-92			CD-7704	Each	1
O' RING & SEAL KIT	1984-92			OR-7580	Kit	4
SOLENOID - FRONT	1984-92	Front	incl O'Ring Kit	SO-7590	Kit	2
SOLENOID - REAR	1984-92	Rear	incl O'Ring Kit	SO-7590	Kit	2
VIBRATION ISOLATOR KIT	1984-92			VI-7550	Kit	1
MARK VIII						
ALL						
AIR COMPRESSOR	1993-98			CD-7708	Each	1
AIR SPRING-REAR	1993-98	Rear		AS-7023	Each	2
AIR STRUT - FRONT LEFT	1993-98	Front Left	Includes Solenoid	AS-7300	Each	1
AIR STRUT - FRONT RIGHT	1993-98	Front Right	Includes Solenoid	AS-7301	Each	1
AIR SUSPENSION KIT - REAR	1993-98	Rear	Direct Replacement Kit	KT-1103	Kit	1
AIR-COIL SPRING CONV KT [FRONT & REAR]	1993-98	Front and Rear	Incl. Coil Over Strut and Re Springs	CK-7845	Kit	1
		Front and Rear	Incl. Coil Over Strut and Re Springs and Shocks	CK-7845WS	Kit	1
AIR-COIL SPRING CONVERSION KT [FRONT]	1993-98	Front	Coil Over Strut	CK-7826	Kit	1
AIR-COIL SPRING CONVERSION KT [REAR]	1993-98	Rear	Springs & Adapters	CK-7836	Kit	1
		Rear	Incl. Rear Springs & Shocks	CK-7836WS	Kit	1
DRYER	1993-98			DR-7900	Each	1
O' RING & SEAL KIT	1993-98			OR-7580	Kit	2
SHOCK ABSORBER - REAR	1993-98	Rear	Replacement Units for Conversion Kit (Per Pair)	SH-1000	Each	1
SOLENOID - FRONT	1993-98	Front	Left & Right	SO-7592	Kit	2
SOLENOID - REAR	1993-98	Rear	incl O'Ring Kit	SO-7592	Kit	2
VIBRATION ISOLATOR KIT	1993-98			VI-7550	Kit	1
TOWN CAR						
ALL						
AIR SPRING-REAR	2003-11	Rear	Sedan	AS-7000	Each	2
		Rear	HD For Limo use.	AS-7050	Each	2
	1998-02	Rear	Sedan	AS-7000	Each	2
		Rear	HD For Limo use.	AS-7050	Each	2

Air Spring Suspension

Part Type	Year	Location	Description	Part No.	Std Pack	Qty/Car
LINCOLN PASSENGER CAR (continued)						
TOWN CAR (continued)						
ALL						
AIR SPRING-REAR	1990-97	Rear	Sedan	AS-7000	Each	2
		Rear	HD For Limo use.	AS-7050	Each	2
AIR SUSPENSION KIT - REAR	2003-11	Rear	Direct Replacement Kit Sedan	KT-1100	Kit	1
		1998-02	Rear	Direct Replacement Kit Sedan	KT-1109	Kit
	1990-97	Rear	Direct Replacement Kit Sedan	KT-1100A	Kit	1
AIR-COIL SPRING CONVERSION KT [REAR]	2003-11	Rear	Coil Springs; Sedan	CK-7800	Kit	1
		Rear	Includes Rear Springs & Shocks; Sedan	CK-7841WS	Kit	1
		Rear	Coil Springs; Limo Pkg.	CK-7843	Kit	1
	1998-02	Rear	Coil Springs; Sedan	CK-7800	Kit	1
		Rear	Includes Rear Springs & Shocks; Sedan	CK-7800WS	Kit	1
		Rear	Coil Springs; Limo Pkg.	CK-7843	Kit	1
	1990-97	Rear	Coil Springs; Sedan	CK-7800	Kit	1
		Rear	Includes Rear Springs & Shocks; Sedan	CK-7800WS	Kit	1
Rear		Coil Springs; Limo Pkg.	CK-7843	Kit	1	
COMPRESSOR - DRYER	2003-11			CD-7700	Each	1
	1998-02			CD-7701	Each	1
	1990-97			CD-7700	Each	1
DRYER	2003-11			DR-7906	Each	1
	1998-02			DR-7900	Each	1
	1990-97			DR-7906	Each	1
O' RING & SEAL KIT	2003-11			OR-7580	Kit	1
	1998-02			OR-7580	Kit	1
	1990-97			OR-7580	Kit	1
SOLENOID - REAR	2003-11	Rear	incl O'Ring Kit	SO-7590	Kit	2
	1998-02	Rear	incl O'Ring Kit	SO-7590	Kit	2
	1990-97	Rear	incl O'Ring Kit	SO-7590	Kit	2
VIBRATION ISOLATOR KIT	2003-11			VI-7550	Kit	1
	1998-02			VI-7550	Kit	1
	1990-97			VI-7550	Kit	1
LINCOLN SPORT UTILITY						
NAVIGATOR						
2WD						
AIR SPRING-REAR	1998-02	Rear		AS-7001	Each	2
AIR SUSPENSION KIT - REAR	1998-02	Rear	Direct Replacement Kit	KT-1101	Kit	1
AIR-COIL SPRING CONVERSION KT [REAR]	1998-02	Rear	Coil Springs plus any necessary adapters	CK-7808	Kit	1
		Rear	Incl. Rear Springs & Shocks	CK-7808WS	Kit	1
COMPRESSOR - DRYER	1998-02			CD-7705	Each	1
DRYER	1998-02			DR-7900	Each	1
O' RING & SEAL KIT	1998-02			OR-7580	Kit	2
SOLENOID - REAR	1998-02	Rear	incl O'Ring Kit	SO-7591	Kit	2
VIBRATION ISOLATOR KIT	1998-02			VI-7550	Kit	1
4WD						
AIR SHOCK - FRONT	1998-02	Front		AS-7400	Each	2
AIR SPRING-REAR	1998-02	Rear		AS-7002	Each	2
AIR SUSPENSION KIT - REAR	1998-02	Rear	Direct Replacement Kit	KT-1102	Kit	1
AIR-COIL SPRING CONV KT [FRONT & REAR]	1998-02	Front and Rear	Incl. Coil Springs, Front & Rear Shocks	CK-7862WS	KIT	1
AIR-COIL SPRING CONVERSION KT [FRONT]	1998-02	Front	Coil Over Shock	CK-7815	Kit	1

Air Spring Suspension

Part Type	Year	Location	Description	Part No.	Std Pack	Qty/Car
LINCOLN SPORT UTILITY (continued)						
NAVIGATOR (continued)						
4WD						
AIR-COIL SPRING CONVERSION KT [REAR]	1998-02	Rear	Coil Springs plus any necessary adapters	CK-7809	Kit	1
		Rear	Incl. Rear Springs & Shocks	CK-7809WS	Kit	1
COMPRESSOR - DRYER	1998-02			CD-7705	Each	1
DRYER	1998-02			DR-7900	Each	1
O' RING & SEAL KIT	1998-02			OR-7580	Kit	2
SOLENOID - REAR	1998-02	Rear	incl O'Ring Kit	SO-7591	Kit	2
VIBRATION ISOLATOR KIT	1998-02			VI-7550	Kit	1
ALL						
AIR SPRING-FRONT	2003-06	Front		AS-7051	Each	2
AIR SPRING-REAR	2007-14	Rear		AS-7039	Each	2
	2003-06	Rear		AS-7054	Each	2
AIR STRUT - FRONT	2003-06	Front	Includes Solenoid	AS-7314	Each	2
AIR STRUT - REAR	2003-06	Rear	Includes Solenoid	AS-7315	Each	2
AIR-COIL SPRING CONV KT [FRONT & REAR]	2003-06	Front and Rear	Coil Over Strut	CK-7846	Kit	1
AIR-COIL SPRING CONVERSION KT [FRONT]	2003-06	Front	Coil Over Strut	CK-7816	Kit	1
AIR-COIL SPRING CONVERSION KT [REAR]	2007-14	Rear	Suspension Light Removal Tool Not Included	CK-7860	Kit	1
	2003-06	Rear	Coil Over Strut	CK-7817	Kit	1
COMPRESSOR - DRYER	2015-18			CD-7722	Each	1
	2007-14			CD-7722	Each	1
	2003-06			CD-7705	Each	1
DRYER	2015-18			DR-7910	Each	1
	2007-14			DR-7910	Each	1
	2003-06			DR-7900	Each	1
O' RING & SEAL KIT	2003-06			OR-7580	Kit	4
SOLENOID - FRONT	2003-06	Front	incl O'Ring Kit	SO-7593	Kit	2
SOLENOID - REAR	2007-14	Rear		SO-7594	Each	2
	2003-06	Rear	incl O'Ring Kit	SO-7593	Kit	2
VIBRATION ISOLATOR KIT	2003-06			VI-7550	Kit	1
LINCOLN TRUCK						
BLACKWOOD						
ALL						
COMPRESSOR - DRYER	2002-03			CD-7705	Each	1
SOLENOID - REAR	2002-03	Rear		SO-7592	Kit	2
MASERATI SUV						
LEVANTE						
ALL						
AIR SPRING-REAR	2017-18	Rear		AS-7091	Each	2
MAYBACH						
57						
ALL						
AIR COMPRESSOR	2003-11			CD-7727	Each	1
62						
ALL						
AIR COMPRESSOR	2003-11			CD-7727	Each	1
57						
ALL						
RIDE HEIGHT SENSOR	2003-11			HS-8506	Each	4

Air Spring Suspension

Part Type	Year	Location	Description	Part No.	Std Pack	Qty/Car
MAYBACH (continued)						
62						
ALL						
RIDE HEIGHT SENSOR	2003-11			HS-8506	Each	4
MERCEDES-BENZ PASSENGER CAR						
C180						
ALL						
AIR SPRING-REAR LEFT	2015-19	Rear Left		AS-17102	EA	1
C200						
ALL						
AIR SPRING-REAR LEFT	2015-19	Rear Left		AS-17102	EA	1
C180						
ALL						
AIR SPRING-REAR RIGHT	2015-19	Rear Right		AS-17103	EA	1
C200						
ALL						
AIR SPRING-REAR RIGHT	2015-19	Rear Right		AS-17103	EA	1
C230						
ALL						
RIDE HEIGHT SENSOR	2002-07			HS-8507	Each	4
C240						
ALL						
RIDE HEIGHT SENSOR	2001-05			HS-8507	Each	4
C280						
ALL						
RIDE HEIGHT SENSOR	2006-07			HS-8507	Each	4
C300						
ALL						
AIR SPRING-REAR LEFT	2015-20	Rear Left		AS-17102	EA	1
AIR SPRING-REAR RIGHT	2015-20	Rear Right		AS-17103	EA	1
C320						
ALL						
RIDE HEIGHT SENSOR	2001-05			HS-8507	Each	4
C32 AMG						
ALL						
RIDE HEIGHT SENSOR	2002-04			HS-8507	Each	4
C350						
ALL						
AIR SPRING-REAR LEFT	2015	Rear Left		AS-17102	EA	1
AIR SPRING-REAR RIGHT	2015	Rear Right		AS-17103	EA	1
RIDE HEIGHT SENSOR	2006			HS-8507	Each	4
C400						
ALL						
AIR SPRING-REAR LEFT	2015	Rear Left		AS-17102	EA	1
AIR SPRING-REAR RIGHT	2015	Rear Right		AS-17103	EA	1
C43 AMG						
ALL						
AIR SPRING-REAR LEFT	2017-20	Rear Left		AS-17102	EA	1
C450 AMG						
ALL						
AIR SPRING-REAR LEFT	2016	Rear Left		AS-17102	EA	1

Air Spring Suspension

Part Type	Year	Location	Description	Part No.	Std Pack	Qty/Car
MERCEDES-BENZ PASSENGER CAR (continued)						
C43 AMG						
ALL						
AIR SPRING-REAR RIGHT	2017-20	Rear Right		AS-17103	EA	1
C450 AMG						
ALL						
AIR SPRING-REAR RIGHT	2016	Rear Right		AS-17103	EA	1
C55 AMG						
ALL						
RIDE HEIGHT SENSOR	2005-06			HS-8507	Each	4
C63 AMG						
ALL						
AIR SPRING-REAR LEFT	2015-20	Rear Left		AS-17102	EA	1
C63 AMG S						
ALL						
AIR SPRING-REAR LEFT	2015-20	Rear Left		AS-17102	EA	1
C63 AMG						
ALL						
AIR SPRING-REAR RIGHT	2015-20	Rear Right		AS-17103	EA	1
C63 AMG S						
ALL						
AIR SPRING-REAR RIGHT	2015-20	Rear Right		AS-17103	EA	1
CL500						
ALL						
AIR STRUT - REAR LEFT	2010-13	Rear Left		AS-7336	Each	1
AIR STRUT - REAR RIGHT	2010-13	Rear Right		AS-7337	Each	1
COMPRESSOR - DRYER	2010-13			CD-7728	Each	1
RIDE HEIGHT SENSOR	2002-06			HS-8507	Each	4
	2000-01			HS-8507	Each	4
CL550						
ALL						
AIR STRUT - REAR LEFT	2007-14	Rear Left		AS-7336	Each	1
AIR STRUT - REAR RIGHT	2007-14	Rear Right		AS-7337	Each	1
COMPRESSOR - DRYER	2007-14			CD-7728	Each	1
CONTROL VALVE	2007-14			CV-0007	Each	1
RIDE HEIGHT SENSOR	2007-14			HS-8507	Each	4
CL55 AMG						
ALL						
RIDE HEIGHT SENSOR	2001-06			HS-8507	Each	4
CL600						
ALL						
AIR STRUT - REAR LEFT	2007-14	Rear Left		AS-7336	Each	1
AIR STRUT - REAR RIGHT	2007-14	Rear Right		AS-7337	Each	1
COMPRESSOR - DRYER	2007-14			CD-7728	Each	1
CONTROL VALVE	2007-14			CV-0007	Each	1
RIDE HEIGHT SENSOR	2007-14			HS-8507	Each	4
RIDE HEIGHT SENSOR	2002-06			HS-8507	Each	4
CL63 AMG						
ALL						
COMPRESSOR - DRYER	2008-14			CD-7728	Each	1
CONTROL VALVE	2008-14			CV-0007	Each	1
RIDE HEIGHT SENSOR	2008-14			HS-8507	Each	4

Air Spring Suspension

Part Type	Year	Location	Description	Part No.	Std Pack	Qty/Car
MERCEDES-BENZ PASSENGER CAR (continued)						
CL65 AMG						
ALL						
COMPRESSOR - DRYER	2008-14			CD-7728	Each	1
CONTROL VALVE	2008-14			CV-0007	Each	1
RIDE HEIGHT SENSOR	2008-14			HS-8507	Each	4
RIDE HEIGHT SENSOR	2005-06			HS-8507	Each	4
CLK320						
ALL						
RIDE HEIGHT SENSOR	1998-05			HS-8507	Each	4
CLK350						
ALL						
RIDE HEIGHT SENSOR	2006-09			HS-8507	Each	4
CLK430						
ALL						
RIDE HEIGHT SENSOR	1999-03			HS-8507	Each	4
CLK500						
ALL						
RIDE HEIGHT SENSOR	2003-06		Active Body Control	HS-8506	Each	4
			w/o Active Body Control	HS-8507	Each	4
CLK550						
ALL						
RIDE HEIGHT SENSOR	2007-09			HS-8507	Each	4
CLK55 AMG						
ALL						
RIDE HEIGHT SENSOR	2001-06			HS-8507	Each	4
CLK63 AMG						
ALL						
RIDE HEIGHT SENSOR	2007-09			HS-8507	Each	4
CLS350						
ALL						
AIR COMPRESSOR	2012-14			CD-7746	Each	1
Mexico						
AIR SPRING-REAR	2007-11	Rear	exc Active Suspension	AS-7036	Each	2
AIR SPRING-REAR LEFT	2007-11	Rear Left	Active Suspension	AS-7034	Each	1
AIR SPRING-REAR RIGHT	2007-11	Rear Right	Active Suspension	AS-7035	Each	1
AIR-COIL SPRING CONV KT [FRONT & REAR]	2007-11	Front and Rear	RWD	CK-7872	Kit	1
COMPRESSOR - DRYER	2007-11			CD-7727	Each	1
SHOCK ABSORBER - REAR	2007-11	Rear		SH-1003	Each	2
CLS400						
ALL						
AIR COMPRESSOR	2015-18			CD-7746	Each	1
AIR SPRING-REAR LEFT	2015-18	Rear Left		AS-7040	Each	1
AIR SPRING-REAR RIGHT	2015-18	Rear Right		AS-7041	Each	1
CLS500						
ALL						
AIR COMPRESSOR	2012-15			CD-7746	Each	1
AIR SPRING-REAR	2007-11	Rear	exc Active Suspension	AS-7036	Each	2
	2006	Rear	exc Active Suspension	AS-7036	Each	2
	2005	Rear	exc Active Suspension	AS-7036	Each	2
AIR SPRING-REAR LEFT	2007-11	Rear Left	Active Suspension	AS-7034	Each	1
	2006	Rear Left	Active Suspension	AS-7034	Each	1
	2005	Rear Left	Active Suspension	AS-7034	Each	1
AIR SPRING-REAR RIGHT	2007-11	Rear Right	Active Suspension	AS-7035	Each	1
	2006	Rear Right	Active Suspension	AS-7035	Each	1

Air Spring Suspension

Part Type	Year	Location	Description	Part No.	Std Pack	Qty/Car
MERCEDES-BENZ PASSENGER CAR (continued)						
CLS500 (continued)						
ALL						
AIR SPRING-REAR RIGHT	2005	Rear Right	Active Suspension	AS-7035	Each	1
AIR-COIL SPRING CONV KT [FRONT & REAR]	2007-11	Front and Rear	RWD	CK-7872	Kit	1
	2006	Front and Rear	RWD	CK-7872	Kit	1
	2005	Front and Rear	RWD	CK-7872	Kit	1
COMPRESSOR - DRYER	2007-11			CD-7727	Each	1
	2006			CD-7727	Each	1
	2005			CD-7727	Each	1
RIDE HEIGHT SENSOR	2006		Active Body Control	HS-8506	Each	4
			w/o Active Body Control	HS-8507	Each	4
SHOCK ABSORBER - REAR	2007-11	Rear		SH-1003	Each	2
	2006	Rear		SH-1003	Each	2
	2005	Rear		SH-1003	Each	2
CLS550						
ALL						
AIR COMPRESSOR	2012-18			CD-7746	Each	1
AIR SPRING-REAR	2007-11	Rear	exc Active Suspension	AS-7036	Each	2
AIR SPRING-REAR LEFT	2012-18	Rear Left		AS-7040	Each	1
	2007-11	Rear Left	Active Suspension	AS-7034	Each	1
AIR SPRING-REAR RIGHT	2012-18	Rear Right		AS-7041	Each	1
	2007-11	Rear Right	Active Suspension	AS-7035	Each	1
AIR-COIL SPRING CONV KT [FRONT & REAR]	2007-11	Front and Rear	RWD	CK-7872	Kit	1
COMPRESSOR - DRYER	2007-11			CD-7727	Each	1
RIDE HEIGHT SENSOR	2007-11			HS-8507	Each	4
CLS55 AMG						
ALL						
AIR STRUT - FRONT LEFT	2006	Front Left	ADS	AS-7396	Each	1
AIR STRUT - FRONT RIGHT	2006	Front Right	ADS	AS-7397	Each	1
AIR-COIL SPRING CONV KT [FRONT & REAR]	2006	Front and Rear	RWD	CK-7872	Kit	1
COMPRESSOR - DRYER	2006			CD-7727	Each	1
RIDE HEIGHT SENSOR	2006		Active Body Control	HS-8506	Each	4
			w/o Active Body Control	HS-8507	Each	4
SHOCK ABSORBER - REAR	2006	Rear		SH-1003	Each	2
CLS63 AMG S						
ALL						
AIR COMPRESSOR	2014-18			CD-7746	Each	1
CLS63 AMG						
ALL						
AIR COMPRESSOR	2012-14			CD-7746	Each	1
CLS63 AMG S						
ALL						
AIR SPRING-REAR LEFT	2014-18	Rear Left		AS-7040	Each	1
CLS63 AMG						
ALL						
AIR SPRING-REAR LEFT	2012-14	Rear Left		AS-7040	Each	1
CLS63 AMG S						
ALL						
AIR SPRING-REAR RIGHT	2014-18	Rear Right		AS-7041	Each	1
CLS63 AMG						
ALL						
AIR SPRING-REAR RIGHT	2012-14	Rear Right		AS-7041	Each	1
AIR STRUT - FRONT LEFT	2007-11	Front Left	ADS	AS-7396	Each	1

Air Spring Suspension

Part Type	Year	Location	Description	Part No.	Std Pack	Qty/Car
MERCEDES-BENZ PASSENGER CAR (continued)						
CLS63 AMG (continued)						
ALL						
AIR STRUT - FRONT RIGHT	2007-11	Front Right	ADS	AS-7397	Each	1
AIR-COIL SPRING CONV KT [FRONT & REAR]	2007-11	Front and Rear	RWD	CK-7872	Kit	1
COMPRESSOR - DRYER	2007-11			CD-7727	Each	1
RIDE HEIGHT SENSOR	2007-11			HS-8507	Each	4
SHOCK ABSORBER - REAR	2007-11	Rear		SH-1003	Each	2
E250						
ALL						
AIR COMPRESSOR	2011-16			CD-7746	Each	1
AIR SPRING-REAR LEFT	2011-16	Rear Left		AS-7040	Each	1
AIR SPRING-REAR RIGHT	2011-16	Rear Right		AS-7041	Each	1
E280						
Mexico						
AIR SPRING-REAR	2007-09	Rear	exc Active Suspension	AS-7036	Each	2
AIR SPRING-REAR LEFT	2007-09	Rear Left	Active Suspension	AS-7034	Each	1
AIR SPRING-REAR RIGHT	2007-09	Rear Right	Active Suspension	AS-7035	Each	1
AIR STRUT - FRONT LEFT	2007-09	Front Left		AS-7331	Each	1
AIR STRUT - FRONT RIGHT	2007-09	Front Right		AS-7332	Each	1
AIR-COIL SPRING CONV KT [FRONT & REAR]	2007-09	Front and Rear	RWD	CK-7872	Kit	1
COMPRESSOR - DRYER	2007-09			CD-7727	Each	1
SHOCK ABSORBER - REAR	2007-09	Rear		SH-1003	Each	2
E300						
ALL						
AIR COMPRESSOR	2010-16			CD-7746	Each	1
RIDE HEIGHT SENSOR	1996-99			HS-8507	Each	4
SHOCK ABSORBER - REAR	2008-09	Rear		SH-1003	Each	2
E320						
ALL						
AIR COMPRESSOR	2002-09			CD-7727	Each	1
AIR SPRING-REAR	2002-09	Rear	exc Active Suspension	AS-7036	Each	2
AIR SPRING-REAR LEFT	2002-09	Rear Left	Active Suspension	AS-7034	Each	1
AIR SPRING-REAR RIGHT	2002-09	Rear Right	Active Suspension	AS-7035	Each	1
AIR STRUT - FRONT LEFT	2002-09	Front Left	Sedan; RWD	AS-7331	Each	1
AIR STRUT - FRONT RIGHT	2002-09	Front Right	Sedan; RWD	AS-7332	Each	1
AIR-COIL SPRING CONV KT [FRONT & REAR]	2002-09	Front and Rear	RWD	CK-7872	Kit	1
RIDE HEIGHT SENSOR	2002-09		Active Body Control	HS-8506	Each	4
			w/o Active Body Control	HS-8507	Each	4
RIDE HEIGHT SENSOR	1996-01			HS-8507	Each	4
SHOCK ABSORBER - REAR	2002-09	Rear		SH-1003	Each	2
E350						
ALL						
AIR COMPRESSOR	2010-16			CD-7746	Each	1
AIR SPRING-REAR	2006-09	Rear	exc Active Suspension	AS-7036	Each	2
AIR SPRING-REAR LEFT	2010-16	Rear Left		AS-7040	Each	1
	2006-09	Rear Left	Active Suspension	AS-7034	Each	1
AIR SPRING-REAR RIGHT	2010-16	Rear Right		AS-7041	Each	1
	2006-09	Rear Right	Active Suspension	AS-7035	Each	1
AIR STRUT - FRONT LEFT	2006-09	Front Left	Sedan; RWD	AS-7331	Each	1
AIR STRUT - FRONT RIGHT	2006-09	Front Right	Sedan; RWD	AS-7332	Each	1
AIR-COIL SPRING CONV KT [FRONT & REAR]	2006-09	Front and Rear	RWD	CK-7872	Kit	1
COMPRESSOR - DRYER	2006-09			CD-7727	Each	1
RIDE HEIGHT SENSOR	2006-09		Active Body Control	HS-8506	Each	4
			w/o Active Body Control	HS-8507	Each	4

Air Spring Suspension

Part Type	Year	Location	Description	Part No.	Std Pack	Qty/Car
MERCEDES-BENZ PASSENGER CAR (continued)						
E350 (continued)						
ALL						
SHOCK ABSORBER - REAR	2006-09	Rear		SH-1003	Each	2
E400						
ALL						
AIR COMPRESSOR	2013-16			CD-7746	Each	1
AIR SPRING-REAR LEFT	2013-16	Rear Left		AS-7040	Each	1
AIR SPRING-REAR RIGHT	2013-16	Rear Right		AS-7041	Each	1
E420						
ALL						
RIDE HEIGHT SENSOR	1997			HS-8507	Each	4
E430						
ALL						
RIDE HEIGHT SENSOR	1998-02			HS-8507	Each	4
E500						
ALL						
AIR SPRING-FRONT	2007-09	Front	Exc. 4-Matic; with ADS	AS-17100	EA	2
	2004-06	Front	Exc. 4-Matic; with ADS	AS-17100	EA	2
		Front	4-Matic; with ADS	AS-17101	EA	2
	2003	Front	Exc. 4-Matic; with ADS	AS-17100	EA	2
AIR SPRING-REAR	2007-09	Rear	exc Active Suspension	AS-7036	Each	2
	2004-06	Rear	exc Active Suspension	AS-7036	Each	2
	2003	Rear	exc Active Suspension	AS-7036	Each	2
AIR SPRING-REAR LEFT	2007-09	Rear Left	Active Suspension	AS-7034	Each	1
	2004-06	Rear Left	Active Suspension	AS-7034	Each	1
	2003	Rear Left	Active Suspension	AS-7034	Each	1
AIR SPRING-REAR RIGHT	2007-09	Rear Right	Active Suspension	AS-7035	Each	1
	2004-06	Rear Right	Active Suspension	AS-7035	Each	1
	2003	Rear Right	Active Suspension	AS-7035	Each	1
AIR STRUT - FRONT LEFT	2007-09	Front Left	Sedan; RWD	AS-7331	Each	1
	2004-06	Front Left	Sedan; RWD	AS-7331	Each	1
	2003	Front Left	Sedan; RWD	AS-7331	Each	1
AIR STRUT - FRONT RIGHT	2007-09	Front Right	Sedan; RWD	AS-7332	Each	1
	2004-06	Front Right	Sedan; RWD	AS-7332	Each	1
	2003	Front Right	Sedan; RWD	AS-7332	Each	1
AIR-COIL SPRING CONV KT [FRONT & REAR]	2007-09	Front and Rear	RWD	CK-7872	Kit	1
	2004-06	Front and Rear	RWD	CK-7872	Kit	1
	2003	Front and Rear	RWD	CK-7872	Kit	1
COMPRESSOR - DRYER	2007-09			CD-7727	Each	1
	2004-06			CD-7727	Each	1
	2003			CD-7727	Each	1
RIDE HEIGHT SENSOR	2004-06		Active Body Control	HS-8506	Each	4
			w/o Active Body Control	HS-8507	Each	4
	2003		Active Body Control	HS-8506	Each	4
			w/o Active Body Control	HS-8507	Each	4
SHOCK ABSORBER - REAR	2007-09	Rear		SH-1003	Each	2
	2004-06	Rear		SH-1003	Each	2
	2003	Rear		SH-1003	Each	2
E550						
ALL						
AIR COMPRESSOR	2010-16			CD-7746	Each	1
AIR SPRING-FRONT	2007-09	Front	Exc. 4-Matic; with ADS	AS-17100	EA	2
		Front	4-Matic; with ADS	AS-17101	EA	2
AIR SPRING-REAR	2007-09	Rear	exc Active Suspension	AS-7036	Each	2
AIR SPRING-REAR LEFT	2010-16	Rear Left		AS-7040	Each	1
	2007-09	Rear Left	Active Suspension	AS-7034	Each	1
AIR SPRING-REAR RIGHT	2010-16	Rear Right		AS-7041	Each	1

Air Spring Suspension

Part Type	Year	Location	Description	Part No.	Std Pack	Qty/Car
MERCEDES-BENZ PASSENGER CAR (continued)						
E550 (continued)						
ALL						
AIR SPRING-REAR RIGHT	2007-09	Rear Right	Active Suspension	AS-7035	Each	1
AIR STRUT - FRONT LEFT	2007-09	Front Left	Sedan; RWD	AS-7331	Each	1
AIR STRUT - FRONT RIGHT	2007-09	Front Right	Sedan; RWD	AS-7332	Each	1
AIR-COIL SPRING CONV KT [FRONT & REAR]	2007-09	Front and Rear	RWD	CK-7872	Kit	1
COMPRESSOR - DRYER	2007-09			CD-7727	Each	1
RIDE HEIGHT SENSOR	2007-09			HS-8507	Each	4
SHOCK ABSORBER - REAR	2007-09	Rear		SH-1003	Each	2
E55 AMG						
ALL						
AIR STRUT - FRONT LEFT	2003-06	Front Left	ADS	AS-7396	Each	1
AIR STRUT - FRONT RIGHT	2003-06	Front Right	ADS	AS-7397	Each	1
AIR-COIL SPRING CONV KT [FRONT & REAR]	2003-06	Front and Rear		CK-7872	Kit	1
COMPRESSOR - DRYER	2003-06		RWD	CD-7727	Each	1
RIDE HEIGHT SENSOR	2003-06			HS-8506	Each	4
SHOCK ABSORBER - REAR	2003-06	Rear		SH-1003	Each	2
E63 AMG						
ALL						
AIR COMPRESSOR	2010-16			CD-7746	Each	1
AIR SPRING-REAR LEFT	2010-16	Rear Left		AS-7040	Each	1
AIR SPRING-REAR RIGHT	2010-16	Rear Right		AS-7041	Each	1
AIR STRUT - FRONT LEFT	2007-09	Front Left	ADS	AS-7396	Each	1
AIR STRUT - FRONT RIGHT	2007-09	Front Right	ADS	AS-7397	Each	1
AIR-COIL SPRING CONV KT [FRONT & REAR]	2007-09	Front and Rear	RWD	CK-7872	Kit	1
COMPRESSOR - DRYER	2007-09			CD-7727	Each	1
RIDE HEIGHT SENSOR	2007-09			HS-8507	Each	4
E63 AMG S						
ALL						
AIR COMPRESSOR	2014-16			CD-7746	Each	1
AIR SPRING-REAR LEFT	2014-16	Rear Left		AS-7040	Each	1
AIR SPRING-REAR RIGHT	2014-16	Rear Right		AS-7041	Each	1
R320						
ALL						
AIR SPRING-FRONT	2007-09	Front		AS-7010	Each	2
AIR SPRING-REAR	2007-09	Rear		AS-7061	Each	2
AIR STRUT - FRONT	2007-09	Front		AS-7319	Each	2
COMPRESSOR - DRYER	2007-09		4-Corner Air Suspension	CD-7729	Each	1
			2-Corner Air Suspension	CD-7730	Each	1
CONTROL VALVE	2007-09			CV-0007	Each	1
RIDE HEIGHT SENSOR	2007-09			HS-8507	Each	4
R350						
ALL						
AIR SPRING-FRONT	2006-13	Front		AS-7010	Each	2
AIR SPRING-REAR	2006-13	Rear		AS-7061	Each	2
AIR STRUT - FRONT	2006-13	Front		AS-7319	Each	2
COMPRESSOR - DRYER	2006-13		4-Corner Air Suspension	CD-7729	Each	1
			2-Corner Air Suspension	CD-7730	Each	1
CONTROL VALVE	2006-13			CV-0007	Each	1
RIDE HEIGHT SENSOR	2006-13			HS-8507	Each	4
R500						
ALL						
AIR SPRING-FRONT	2006-08	Front		AS-7010	Each	2
AIR SPRING-REAR	2006-08	Rear		AS-7061	Each	2

Air Spring Suspension

Part Type	Year	Location	Description	Part No.	Std Pack	Qty/Car
MERCEDES-BENZ PASSENGER CAR (continued)						
R500 (continued)						
ALL						
AIR STRUT - FRONT	2006-08	Front		AS-7319	Each	2
COMPRESSOR - DRYER	2006-08		4-Corner Air Suspension	CD-7729	Each	1
			2-Corner Air Suspension	CD-7730	Each	1
CONTROL VALVE	2006-08			CV-0007	Each	1
RIDE HEIGHT SENSOR	2006-08			HS-8507	Each	4
R550						
ALL						
AIR SPRING-FRONT	2008	Front		AS-7010	Each	2
AIR SPRING-REAR	2008	Rear		AS-7061	Each	2
AIR STRUT - FRONT	2008	Front		AS-7319	Each	2
COMPRESSOR - DRYER	2008		4-Corner Air Suspension	CD-7729	Each	1
			2-Corner Air Suspension	CD-7730	Each	1
CONTROL VALVE	2008			CV-0007	Each	1
R63 AMG						
ALL						
AIR SPRING-FRONT	2007	Front		AS-7010	Each	2
AIR SPRING-REAR	2007	Rear		AS-7061	Each	2
COMPRESSOR - DRYER	2007		4-Corner Air Suspension	CD-7729	Each	1
			2-Corner Air Suspension	CD-7730	Each	1
CONTROL VALVE	2007			CV-0007	Each	1
RIDE HEIGHT SENSOR	2007			HS-8507	Each	4
S350						
ALL						
AIR COMPRESSOR	2011-13			CD-7728	Each	1
AIR STRUT - FRONT	2006	Front	w/o Active Body Control	AS-7333	Each	2
AIR STRUT - REAR	2006	Rear	w/o Active Body Control	AS-7334	Each	2
AIR-COIL SPRING CONV KT [FRONT & REAR]	2006	Front and Rear	w/ Airmatic Suspension; exc 4-Matic	CK-7868	Kit	1
COMPRESSOR - DRYER	2006			CD-7727	Each	1
CONTROL VALVE	2011-13			CV-0007	Each	1
	2006			CV-0006	Each	1
RIDE HEIGHT SENSOR	2011-13			HS-8507	Each	4
	2006		Active Body Control	HS-8506	Each	4
			w/o Active Body Control	HS-8507	Each	4
S400						
ALL						
AIR STRUT - FRONT	2010-13	Front	Exc. 4-Matic	AS-7335	Each	2
AIR STRUT - REAR LEFT	2010-13	Rear Left		AS-7336	Each	1
AIR STRUT - REAR RIGHT	2010-13	Rear Right		AS-7337	Each	1
COMPRESSOR - DRYER	2010-13			CD-7728	Each	1
CONTROL VALVE	2010-13			CV-0007	Each	1
RIDE HEIGHT SENSOR	2010-13			HS-8507	Each	4
S430						
ALL						
AIR COMPRESSOR	2003-06			CD-7727	Each	1
	2002			CD-7727	Each	1
AIR STRUT - FRONT	2003-06	Front	exc. 4-Matic; w/o Active Bod Control	AS-7333	Each	2
	2002	Front	exc. 4-Matic; w/o Active Bod Control	AS-7333	Each	2
AIR STRUT - FRONT LEFT	2003-06	Front Left	4-Matic	AS-7348	Each	1
AIR STRUT - FRONT RIGHT	2003-06	Front Right	4-Matic	AS-7349	Each	1
AIR STRUT - REAR	2003-06	Rear	w/o Active Body Control	AS-7334	Each	2
	2002	Rear	w/o Active Body Control	AS-7334	Each	2
AIR-COIL SPRING CONV KT [FRONT & REAR]	2003-06	Front and Rear	w/ Airmatic Suspension; exc 4-Matic	CK-7868	Kit	1

Air Spring Suspension

Part Type	Year	Location	Description	Part No.	Std Pack	Qty/Car
MERCEDES-BENZ PASSENGER CAR (continued)						
S430 (continued)						
ALL						
AIR-COIL SPRING CONV KT [FRONT & REAR]	2002	Front and Rear	w/ Airmatic Suspension; exc 4-Matic	CK-7868	Kit	1
	2000-01	AIR-COIL SPRI CONV KT [FRONT & REA	w/ Airmatic Suspension; exc 4-Matic	CK-7868	Kit	1
CONTROL VALVE	2003-06			CV-0006	Each	1
	2002			CV-0006	Each	1
	2000-01			CV-0006	Each	1
RIDE HEIGHT SENSOR	2003-06		Active Body Control	HS-8506	Each	4
			w/o Active Body Control	HS-8507	Each	4
	2002		Active Body Control	HS-8506	Each	4
			w/o Active Body Control	HS-8507	Each	4
	2000-01		Active Body Control	HS-8506	Each	4
			w/o Active Body Control	HS-8507	Each	4
S450						
ALL						
AIR STRUT - FRONT	2008-11	Front	Exc. 4-Matic	AS-7335	Each	2
AIR STRUT - REAR LEFT	2008-11	Rear Left		AS-7336	Each	1
AIR STRUT - REAR RIGHT	2008-11	Rear Right		AS-7337	Each	1
COMPRESSOR - DRYER	2008-11			CD-7728	Each	1
CONTROL VALVE	2008-11			CV-0007	Each	1
S500						
ALL						
AIR COMPRESSOR	2003-06			CD-7727	Each	1
	2002			CD-7727	Each	1
	2000-01			CD-7727	Each	1
AIR STRUT - FRONT	2010-11	Front	Exc. 4-Matic	AS-7335	Each	2
	2003-06	Front	exc. 4-Matic; w/o Active Bod Control	AS-7333	Each	2
	2002	Front	exc. 4-Matic; w/o Active Bod Control	AS-7333	Each	2
AIR STRUT - FRONT LEFT	2003-06	Front Left	4-Matic	AS-7348	Each	1
AIR STRUT - FRONT RIGHT	2003-06	Front Right	4-Matic	AS-7349	Each	1
AIR STRUT - REAR	2003-06	Rear	w/o Active Body Control	AS-7334	Each	2
	2002	Rear	w/o Active Body Control	AS-7334	Each	2
AIR STRUT - REAR LEFT	2010-11	Rear Left		AS-7336	Each	1
AIR STRUT - REAR RIGHT	2010-11	Rear Right		AS-7337	Each	1
AIR-COIL SPRING CONV KT [FRONT & REAR]	2003-06	Front and Rear	w/ Airmatic Suspension; exc 4-Matic	CK-7868	Kit	1
	2002	Front and Rear	w/ Airmatic Suspension; exc 4-Matic	CK-7868	Kit	1
	2000-01	AIR-COIL SPRI CONV KT [FRONT & REA	w/ Airmatic Suspension; exc 4-Matic	CK-7868	Kit	1
COMPRESSOR - DRYER	2010-11			CD-7728	Each	1
CONTROL VALVE	2010-11			CV-0007	Each	1
	2003-06			CV-0006	Each	1
	2002			CV-0006	Each	1
	2000-01			CV-0006	Each	1
RIDE HEIGHT SENSOR	2003-06		Active Body Control	HS-8506	Each	4
			w/o Active Body Control	HS-8507	Each	4
	2002		Active Body Control	HS-8506	Each	4
			w/o Active Body Control	HS-8507	Each	4
	2000-01		Active Body Control	HS-8506	Each	4
			w/o Active Body Control	HS-8507	Each	4

Air Spring Suspension

Part Type	Year	Location	Description	Part No.	Std Pack	Qty/Car
MERCEDES-BENZ PASSENGER CAR (continued)						
S550						
ALL						
AIR STRUT - FRONT	2007-13	Front	Exc. 4-Matic	AS-7335	Each	2
AIR STRUT - REAR LEFT	2007-13	Rear Left		AS-7336	Each	1
AIR STRUT - REAR RIGHT	2007-13	Rear Right		AS-7337	Each	1
COMPRESSOR - DRYER	2007-13			CD-7728	Each	1
CONTROL VALVE	2007-13			CV-0007	Each	1
CONTROL VALVE	2014-17			CV-0007	Each	1
RIDE HEIGHT SENSOR	2007-13			HS-8507	Each	4
S55 AMG						
ALL						
COMPRESSOR - DRYER	2002-06			CD-7727	Each	1
CONTROL VALVE	2002-06			CV-0006	Each	1
	2001			CV-0006	Each	1
RIDE HEIGHT SENSOR	2002-06		Active Body Control	HS-8506	Each	4
			w/o Active Body Control	HS-8507	Each	4
	2001			HS-8507	Each	4
S600						
ALL						
AIR COMPRESSOR	2002-06			CD-7727	Each	1
AIR STRUT - FRONT	2008-13	Front	Exc. 4-Matic	AS-7335	Each	2
	2002-06	Front	w/o Active Body Control	AS-7333	Each	2
AIR STRUT - REAR	2002-06	Rear	w/o Active Body Control	AS-7334	Each	2
AIR STRUT - REAR LEFT	2008-13	Rear Left		AS-7336	Each	1
AIR STRUT - REAR RIGHT	2008-13	Rear Right		AS-7337	Each	1
AIR-COIL SPRING CONV KT [FRONT & REAR]	2002-06	Front and Rear	w/ Airmatic Suspension; exc 4-Matic	CK-7868	Kit	1
	2001	AIR-COIL SPRI CONV KT [FRONT & REA	w/ Airmatic Suspension; exc 4-Matic	CK-7868	Kit	1
COMPRESSOR - DRYER	2008-13			CD-7728	Each	1
CONTROL VALVE	2008-13			CV-0007	Each	1
	2002-06			CV-0006	Each	1
	2001			CV-0006	Each	1
CONTROL VALVE	2015-17			CV-0007	Each	1
RIDE HEIGHT SENSOR	2008-13			HS-8507	Each	4
	2002-06		Active Body Control	HS-8506	Each	4
			w/o Active Body Control	HS-8507	Each	4
	2001		Active Body Control	HS-8506	Each	4
			w/o Active Body Control	HS-8507	Each	4
S63 AMG						
ALL						
COMPRESSOR - DRYER	2008-13			CD-7728	Each	1
CONTROL VALVE	2008-13			CV-0007	Each	1
CONTROL VALVE	2014-17			CV-0007	Each	1
RIDE HEIGHT SENSOR	2008-13			HS-8507	Each	4
S65 AMG						
ALL						
COMPRESSOR - DRYER	2008-13			CD-7728	Each	1
	2006-07			CD-7727	Each	1
CONTROL VALVE	2008-13			CV-0007	Each	1
RIDE HEIGHT SENSOR	2008-13			HS-8507	Each	4
	2006-07		Active Body Control	HS-8506	Each	4
			w/o Active Body Control	HS-8507	Each	4

Air Spring Suspension

Part Type	Year	Location	Description	Part No.	Std Pack	Qty/Car
MERCEDES-BENZ SPORT UTILITY						
G63 AMG						
ALL						
CONTROL VALVE	2013-16			CV-0007	Each	1
GL320						
ALL						
AIR SPRING-FRONT	2007-09	Front		AS-7011	Each	2
AIR SPRING-REAR	2007-09	Rear		AS-7060	Each	2
AIR STRUT - FRONT	2007-09	Front	w/o ADS	AS-7320	Each	2
		Front	ADS	AS-7321	Each	2
COMPRESSOR - DRYER	2007-09			CD-7731	Each	1
CONTROL VALVE	2007-09			CV-0007	Each	1
RIDE HEIGHT SENSOR	2007-09			HS-8507	Each	4
SHOCK ABSORBER - REAR	2007-09	Rear	ADS; (Electronic)	AS-7206	Each	2
		Rear	w/o ADS	AS-7207	Each	2
GL350						
ALL						
AIR COMPRESSOR	2012-16			CD-7753	Each	1
AIR SPRING-FRONT	2010-11	Front		AS-7011	Each	2
AIR SPRING-FRONT LEFT	2012-16	Front Left		AS-7079	Each	1
AIR SPRING-FRONT RIGHT	2012-16	Front Right		AS-7080	Each	1
AIR SPRING-REAR	2012-16	Rear		AS-7060	Each	2
	2010-11	Rear		AS-7060	Each	2
AIR STRUT - FRONT	2010-11	Front	w/o ADS	AS-7320	Each	2
		Front	ADS	AS-7321	Each	2
AIR STRUT - FRONT LEFT	2012-16	Front Left	w/ Adaptive Drive System	AS-7372	Each	1
		Front Left	w/o ADS	AS-7374	Each	1
AIR STRUT - FRONT RIGHT	2012-16	Front Right	w/ Adaptive Drive System	AS-7373	Each	1
		Front Right	w/o ADS	AS-7375	Each	1
COMPRESSOR - DRYER	2010-11			CD-7731	Each	1
CONTROL VALVE	2012-16			CV-0007	Each	1
	2010-11			CV-0007	Each	1
RIDE HEIGHT SENSOR	2010-11			HS-8507	Each	4
SHOCK ABSORBER - REAR	2010-11	Rear	ADS; (Electronic)	AS-7206	Each	2
		Rear	w/o ADS	AS-7207	Each	2
GL450						
ALL						
AIR COMPRESSOR	2015-16			CD-7753	Each	1
	2013-14			CD-7753	Each	1
AIR SPRING-FRONT	2007-12	Front		AS-7011	Each	2
AIR SPRING-FRONT LEFT	2015-16	Front Left		AS-7079	Each	1
	2013-14	Front Left		AS-7079	Each	1
AIR SPRING-FRONT RIGHT	2015-16	Front Right		AS-7080	Each	1
	2013-14	Front Right		AS-7080	Each	1
AIR SPRING-REAR	2015-16	Rear		AS-7060	Each	2
	2013-14	Rear		AS-7060	Each	2
	2007-12	Rear		AS-7060	Each	2
AIR STRUT - FRONT	2007-12	Front	w/o ADS	AS-7320	Each	2
		Front	ADS	AS-7321	Each	2
AIR STRUT - FRONT LEFT	2015-16	Front Left	w/ Adaptive Drive System	AS-7372	Each	1
		Front Left	w/o ADS	AS-7374	Each	1
	2013-14	Front Left	w/o ADS	AS-7374	Each	1
AIR STRUT - FRONT RIGHT	2015-16	Front Right	w/ Adaptive Drive System	AS-7373	Each	1
		Front Right	w/o ADS	AS-7375	Each	1
	2013-14	Front Right	w/o ADS	AS-7375	Each	1
COMPRESSOR - DRYER	2007-12			CD-7731	Each	1
CONTROL VALVE	2015-16			CV-0007	Each	1
	2013-14			CV-0007	Each	1
	2007-12			CV-0007	Each	1
RIDE HEIGHT SENSOR	2007-12			HS-8507	Each	4

Air Spring Suspension

Part Type	Year	Location	Description	Part No.	Std Pack	Qty/Car
MERCEDES-BENZ SPORT UTILITY (continued)						
GL450 (continued)						
ALL						
SHOCK ABSORBER - REAR	2007-12	Rear	ADS; (Electronic)	AS-7206	Each	2
		Rear	w/o ADS	AS-7207	Each	2
GL500						
ALL						
AIR SPRING-REAR	2013-15	Rear		AS-7060	Each	2
Mexican Vehicle						
AIR COMPRESSOR	2010-12			CD-7731	Each	1
AIR SPRING-FRONT	2010-12	Front		AS-7011	Each	2
AIR SPRING-REAR	2010-12	Rear		AS-7060	Each	2
AIR STRUT - FRONT	2010-12	Front	w/o ADS	AS-7320	Each	2
		Front	ADS	AS-7321	Each	2
CONTROL VALVE	2010-12			CV-0007	Each	1
GL550						
ALL						
AIR COMPRESSOR	2013-16			CD-7753	Each	1
	2008-12			CD-7731	Each	1
AIR SPRING-FRONT	2008-12	Front		AS-7011	Each	2
AIR SPRING-FRONT LEFT	2013-16	Front Left		AS-7079	Each	1
AIR SPRING-FRONT RIGHT	2013-16	Front Right		AS-7080	Each	1
AIR SPRING-REAR	2013-16	Rear		AS-7060	Each	2
	2008-12	Rear		AS-7060	Each	2
AIR STRUT - FRONT	2008-12	Front	w/o ADS	AS-7320	Each	2
		Front	ADS	AS-7321	Each	2
AIR STRUT - FRONT LEFT	2013-16	Front Left	w/ Adaptive Drive System	AS-7372	Each	1
		Front Left	w/o ADS	AS-7374	Each	1
AIR STRUT - FRONT RIGHT	2013-16	Front Right	w/ Adaptive Drive System	AS-7373	Each	1
		Front Right	w/o ADS	AS-7375	Each	1
CONTROL VALVE	2013-16			CV-0007	Each	1
	2008-12			CV-0007	Each	1
RIDE HEIGHT SENSOR	2008-12			HS-8507	Each	4
SHOCK ABSORBER - REAR	2008-12	Rear	ADS; (Electronic)	AS-7206	Each	2
GL63 AMG						
ALL						
AIR COMPRESSOR	2013-16			CD-7753	Each	1
AIR SPRING-FRONT LEFT	2013-16	Front Left		AS-7079	Each	1
AIR SPRING-FRONT RIGHT	2013-16	Front Right		AS-7080	Each	1
AIR SPRING-REAR	2013-16	Rear		AS-7060	Each	2
AIR STRUT - FRONT LEFT	2013-16	Front Left	w/ Adaptive Drive System	AS-37100	Each	1
AIR STRUT - FRONT RIGHT	2013-16	Front Right	w/ Adaptive Drive System	AS-37101	Each	1
CONTROL VALVE	2013-16			CV-0007	Each	1
GLE300D						
ALL						
AIR SPRING-REAR	2016-17	Rear		AS-7060	Each	2
CONTROL VALVE	2016-17			CV-0007	Each	1
GLE350						
ALL						
AIR COMPRESSOR	2016-18			CD-7753	Each	1
AIR SPRING-REAR	2016-18	Rear		AS-7060	Each	2
CONTROL VALVE	2016-18			CV-0007	Each	1
GLE350D						
ALL						
AIR COMPRESSOR	2016			CD-7753	Each	1
CONTROL VALVE	2016			CV-0007	Each	1

Air Spring Suspension

Part Type	Year	Location	Description	Part No.	Std Pack	Qty/Car
MERCEDES-BENZ SPORT UTILITY (continued)						
GLE400						
ALL						
AIR COMPRESSOR	2016-17			CD-7753	Each	1
AIR SPRING-REAR	2016-17	Rear		AS-7060	Each	2
CONTROL VALVE	2016-17			CV-0007	Each	1
GLE43 AMG						
ALL						
AIR COMPRESSOR	2017-18			CD-7753	Each	1
CONTROL VALVE	2017-18			CV-0007	Each	1
GLE450 AMG						
ALL						
AIR COMPRESSOR	2016-17			CD-7753	Each	1
CONTROL VALVE	2016-17			CV-0007	Each	1
GLE550						
ALL						
AIR COMPRESSOR	2016-18			CD-7753	Each	1
CONTROL VALVE	2016-18			CV-0007	Each	1
GLE550E						
ALL						
AIR COMPRESSOR	2016-18			CD-7753	Each	1
CONTROL VALVE	2016-18			CV-0007	Each	1
GLE63 AMG						
ALL						
AIR COMPRESSOR	2016-19			CD-7753	Each	1
GLE63 AMG S						
ALL						
AIR COMPRESSOR	2016-19			CD-7753	Each	1
GLE63 AMG						
ALL						
AIR STRUT - FRONT LEFT	2016-19	Front Left	w/ Adaptive Drive System	AS-37100	Each	1
GLE63 AMG S						
ALL						
AIR STRUT - FRONT LEFT	2016-19	Front Left	w/ Adaptive Drive System	AS-37100	Each	1
GLE63 AMG						
ALL						
AIR STRUT - FRONT RIGHT	2016-19	Front Right	w/ Adaptive Drive System	AS-37101	Each	1
GLE63 AMG S						
ALL						
AIR STRUT - FRONT RIGHT	2016-19	Front Right	w/ Adaptive Drive System	AS-37101	Each	1
GLE63 AMG						
ALL						
CONTROL VALVE	2016-19			CV-0007	Each	1
GLE63 AMG S						
ALL						
CONTROL VALVE	2016-19			CV-0007	Each	1
GLS450						
ALL						
AIR COMPRESSOR	2017-19			CD-7753	Each	1
AIR SPRING-REAR	2017-19	Rear		AS-7060	Each	2
CONTROL VALVE	2017-19			CV-0007	Each	1

Air Spring Suspension

Part Type	Year	Location	Description	Part No.	Std Pack	Qty/Car
MERCEDES-BENZ SPORT UTILITY (continued)						
GLS550						
ALL						
AIR COMPRESSOR	2017-19			CD-7753	Each	1
AIR SPRING-REAR	2017-19	Rear		AS-7060	Each	2
CONTROL VALVE	2017-19			CV-0007	Each	1
GLS63 AMG						
ALL						
AIR COMPRESSOR	2017-19			CD-7753	Each	1
AIR SPRING-REAR	2017-19	Rear		AS-7060	Each	2
CONTROL VALVE	2017-19			CV-0007	Each	1
ML250						
ALL						
CONTROL VALVE	2015			CV-0007	Each	1
ML320						
ALL						
AIR SPRING-FRONT	2007-09	Front		AS-7011	Each	2
AIR SPRING-REAR	2007-09	Rear		AS-7060	Each	2
AIR STRUT - FRONT	2007-09	Front	w/o ADS	AS-7320	Each	2
		Front	ADS	AS-7321	Each	2
COMPRESSOR - DRYER	2007-09			CD-7731	Each	1
CONTROL VALVE	2007-09			CV-0007	Each	1
RIDE HEIGHT SENSOR	1998-03			HS-8507	Each	4
SHOCK ABSORBER - REAR	2007-09	Rear	ADS; (Electronic)	AS-7206	Each	2
		Rear	w/o ADS	AS-7207	Each	2
ML350						
ALL						
AIR COMPRESSOR	2012-15			CD-7753	Each	1
	2003-11			CD-7731	Each	1
AIR SPRING-FRONT	2003-11	Front		AS-7011	Each	2
AIR SPRING-REAR	2012-15	Rear		AS-7060	Each	2
	2003-11	Rear		AS-7060	Each	2
AIR STRUT - FRONT	2003-11	Front	w/o ADS	AS-7320	Each	2
		Front	ADS	AS-7321	Each	2
AIR STRUT - FRONT LEFT	2012-15	Front Left	w/ Adaptive Drive System	AS-7350	Each	1
AIR STRUT - FRONT RIGHT	2012-15	Front Right	w/ Adaptive Drive System	AS-7351	Each	1
CONTROL VALVE	2012-15			CV-0007	Each	1
	2003-11			CV-0007	Each	1
RIDE HEIGHT SENSOR	2003-11			HS-8507	Each	4
SHOCK ABSORBER - REAR	2003-11	Rear	ADS; (Electronic)	AS-7206	Each	2
		Rear	w/o ADS	AS-7207	Each	2
ML400						
ALL						
AIR COMPRESSOR	2015			CD-7753	Each	1
AIR SPRING-REAR	2015	Rear		AS-7060	Each	2
CONTROL VALVE	2015			CV-0007	Each	1
ML430						
ALL						
RIDE HEIGHT SENSOR	1999-01			HS-8507	Each	4
ML450						
ALL						
AIR SPRING-FRONT	2010-11	Front		AS-7011	Each	2
AIR SPRING-REAR	2010-11	Rear		AS-7060	Each	2
AIR STRUT - FRONT	2010-11	Front	w/o ADS	AS-7320	Each	2
		Front	ADS	AS-7321	Each	2
COMPRESSOR - DRYER	2010-11			CD-7731	Each	1
CONTROL VALVE	2010-11			CV-0007	Each	1
RIDE HEIGHT SENSOR	2010-11			HS-8507	Each	4

Air Spring Suspension

Part Type	Year	Location	Description	Part No.	Std Pack	Qty/Car
MERCEDES-BENZ SPORT UTILITY (continued)						
ML500						
ALL						
AIR SPRING-FRONT	2005-07	Front		AS-7011	Each	2
AIR SPRING-REAR	2005-07	Rear		AS-7060	Each	2
AIR SPRING-REAR	2013-15	Rear		AS-7060	Each	2
COMPRESSOR - DRYER	2005-07			CD-7731	Each	1
RIDE HEIGHT SENSOR	2005-07			HS-8507	Each	4
RIDE HEIGHT SENSOR	2002-04			HS-8507	Each	4
ML550						
ALL						
AIR COMPRESSOR	2012-15			CD-7753	Each	1
AIR SPRING-FRONT	2008-11	Front		AS-7011	Each	2
AIR SPRING-REAR	2012-15	Rear		AS-7060	Each	2
	2008-11	Rear		AS-7060	Each	2
AIR STRUT - FRONT	2008-11	Front	w/o ADS	AS-7320	Each	2
		Front	ADS	AS-7321	Each	2
COMPRESSOR - DRYER	2008-11			CD-7731	Each	1
CONTROL VALVE	2012-15			CV-0007	Each	1
	2008-11			CV-0007	Each	1
RIDE HEIGHT SENSOR	2008-11			HS-8507	Each	4
ML55 AMG						
ALL						
RIDE HEIGHT SENSOR	2000-03			HS-8507	Each	4
ML63 AMG						
ALL						
AIR COMPRESSOR	2012-15			CD-7753	Each	1
AIR SPRING-FRONT	2007-11	Front		AS-7011	Each	2
AIR SPRING-FRONT LEFT	2012-15	Front Left		AS-7079	Each	1
AIR SPRING-FRONT RIGHT	2012-15	Front Right		AS-7080	Each	1
AIR SPRING-REAR	2012-15	Rear		AS-7060	Each	2
	2007-11	Rear		AS-7060	Each	2
AIR STRUT - FRONT	2007-11	Front		AS-7361	Each	2
AIR STRUT - FRONT LEFT	2012-15	Front Left	w/ Adaptive Drive System	AS-37100	Each	1
AIR STRUT - FRONT RIGHT	2012-15	Front Right	w/ Adaptive Drive System	AS-37101	Each	1
COMPRESSOR - DRYER	2007-11			CD-7731	Each	1
CONTROL VALVE	2012-15			CV-0007	Each	1
	2007-11			CV-0007	Each	1
RIDE HEIGHT SENSOR	2007-11			HS-8507	Each	4
MERCEDES-BENZ VAN						
VIANO						
ALL						
AIR SPRING-REAR	1996-03	Rear		AS-7900	Each	2
VITO						
ALL						
AIR SPRING-REAR	2009-13	Rear		AS-7901	Each	2
MERCURY PASSENGER CAR						
GRAND MARQUIS						
ALL						
AIR SPRING-REAR	2003-11	Rear		AS-7000	Each	2
	1998-02	Rear		AS-7000	Each	2
	1990-97	Rear		AS-7000	Each	2
AIR SUSPENSION KIT - REAR	2003-11	Rear	Direct Replacement Kit	KT-1100A	Kit	1
	1998-02	Rear	Direct Replacement Kit	KT-1100A	Kit	1
	1990-97	Rear	Direct Replacement Kit	KT-1100A	Kit	1
AIR-COIL SPRING CONVERSION KIT [REAR]	2003-11	Rear	Coil Springs plus any necessary adapters	CK-7800	Kit	1

Air Spring Suspension

Part Type	Year	Location	Description	Part No.	Std Pack	Qty/Car
MERCURY PASSENGER CAR (continued)						
GRAND MARQUIS (continued)						
ALL						
AIR-COIL SPRING CONVERSION KT [REAR]	2003-11	Rear	Incl. Rear Springs & Shocks	CK-7841WS	Kit	1
	1998-02	Rear	Coil Springs plus any necessary adapters	CK-7800	Kit	1
		Rear	Incl. Rear Springs & Shocks	CK-7841WS	Kit	1
	1990-97	Rear	Coil Springs plus any necessary adapters	CK-7800	Kit	1
		Rear	Incl. Rear Springs & Shocks	CK-7841WS	Kit	1
COMPRESSOR - DRYER	2003-11			CD-7700	Each	1
	1998-02			CD-7700	Each	1
	1990-97			CD-7700	Each	1
DRYER	2003-11			DR-7906	Each	1
	1998-02			DR-7906	Each	1
	1990-97			DR-7906	Each	1
O' RING & SEAL KIT	2003-11			OR-7580	Kit	2
	1998-02			OR-7580	Kit	2
	1990-97			OR-7580	Kit	2
SOLENOID - REAR	2003-11	Rear	incl O'Ring Kit	SO-7590	Kit	2
	1998-02	Rear	incl O'Ring Kit	SO-7590	Kit	2
	1990-97	Rear	incl O'Ring Kit	SO-7590	Kit	2
VIBRATION ISOLATOR KIT	2003-11			VI-7550	Kit	1
	1998-02			VI-7550	Kit	1
	1990-97			VI-7550	Kit	1
MARAUDER						
ALL						
AIR COMPRESSOR	2003-04			CD-7772	Each	1
AIR SPRING-REAR	2003-04	Rear		AS-7000	Each	2
AIR-COIL SPRING CONVERSION KT [REAR]	2003-04	Rear	Springs & Adapters	CK-7800	Kit	1
		Rear	Incl. Rear Springs & Shocks	CK-7841WS	Kit	1
DRYER	2003-04			DR-7907	Each	1
O' RING & SEAL KIT	2003-04			OR-7580	Kit	2
SOLENOID - REAR	2003-04	Rear	incl O'Ring Kit	SO-7590	Kit	2
VIBRATION ISOLATOR KIT	2003-04			VI-7550	Kit	1
MERCURY SPORT UTILITY						
MOUNTAINEER						
ALL						
AIR-COIL SPRING CONVERSION KT [FRONT]	1997-01	Front		CK-7840	Kit	1
AIR-COIL SPRING CONVERSION KT [REAR]	1997-01	Rear	Coil Over Shock	CK-7819	Kit	1
NISSAN SPORT UTILITY						
ARMADA						
ALL						
AIR COMPRESSOR	2005-15			CD-7763	Each	1
OLDSMOBILE PASSENGER CAR						
88						
ALL						
AIR-COIL SPRING CONVERSION KT [REAR]	1996-99	Rear		CK-7613	Kit	1
COMPRESSOR - DRYER	1996-99			CD-7720	Each	1
	1992-95			CD-7719	Each	1
DRYER	1996-99			DR-7908	Each	1
	1992-95			DR-7908	Each	1

Air Spring Suspension

Part Type	Year	Location	Description	Part No.	Std Pack	Qty/Car
OLDSMOBILE PASSENGER CAR (continued)						
98						
ALL						
AIR-COIL SPRING CONVERSION KT [FRONT]	1985-90	Front		CK-7632	Kit	1
AIR-COIL SPRING CONVERSION KT [REAR]	1996	Rear		CK-7613	Kit	1
	1991-95	Rear		CK-7613	Kit	1
COMPRESSOR - DRYER	1996			CD-7720	Each	1
	1991-95			CD-7719	Each	1
DRYER	1996			DR-7908	Each	1
	1991-95			DR-7908	Each	1
AURORA						
ALL						
AIR-COIL SPRING CONVERSION KT [FRONT]	1997-99	Front	w/ Springs	CK-7635	Kit	1
AIR-COIL SPRING CONVERSION KT [REAR]	2001-03	Rear	Passive Air System; Exc. Magna-Ride Control Suspension	CK-7615	Kit	1
		Rear	Coil Over Shock; Exc. Magn Ride Suspension	CK-7616	Kit	1
	1997-99	Rear	Passive Air System	CK-7615	Kit	1
		Rear	Coil Over Shock	CK-7616	Kit	1
	1995-96	Rear	Passive Air System	CK-7615	Kit	1
		Rear	Coil Over Shock	CK-7616	Kit	1
COMPRESSOR - DRYER	2001-03			CD-7714	Each	1
	1997-99			CD-7714	Each	1
DRYER	2001-03			DR-7909	Each	1
	1997-99			DR-7909	Each	1
	1995-96			DR-7909	Each	1
DELTA 88						
ALL						
COMPRESSOR - DRYER	1987-91			CD-7719	Each	1
DRYER	1987-91			DR-7908	Each	1
REGENCY						
ALL						
AIR-COIL SPRING CONVERSION KT [REAR]	1997-98	Rear		CK-7613	Kit	1
COMPRESSOR - DRYER	1997-98			CD-7720	Each	1
DRYER	1997-98			DR-7908	Each	1
TORONADO						
ALL						
AIR-COIL SPRING CONVERSION KT [FRONT]	1990-92	Front		CK-7633	Kit	1
OLDSMOBILE SPORT UTILITY						
BRAVADA						
ALL						
AIR SPRING-REAR	2002-04	Rear		AS-7056	Each	2
AIR-COIL SPRING CONVERSION KT [REAR]	2002-04	Rear	Springs & Adapters	CK-7626	Kit	1
		Rear	Incl. Rear Springs & Shocks	CK-7626WS	Kit	1
OLDSMOBILE VAN						
SILHOUETTE						
ALL						
AIR SHOCK - REAR	2004	Rear		AS-7404	Each	2
	1997-03	Rear		AS-7404	Each	2
AIR-COIL SPRING CONVERSION KT [REAR]	1990-96	Rear		CK-7603	Kit	1

Air Spring Suspension

Part Type	Year	Location	Description	Part No.	Std Pack	Qty/Car
OLDSMOBILE VAN (continued)						
SILHOUETTE (continued)						
ALL						
COMPRESSOR - DRYER	2004			CD-7712	Each	1
	1997-03			CD-7712	Each	1
PONTIAC PASSENGER CAR						
BONNEVILLE						
ALL						
AIR-COIL SPRING CONVERSION KT [FRONT]	1987-90	Front		CK-7632	Kit	1
AIR-COIL SPRING CONVERSION KT [REAR]	2000-05	Rear	Passive Air System; Exc. Magna-Ride Control Suspension	CK-7615	Kit	1
		Rear	Coil Over Shock; Exc. Magn Ride Suspension	CK-7616	Kit	1
	1996-99	Rear		CK-7613	Kit	1
	1991-95	Rear		CK-7613	Kit	1
COMPRESSOR - DRYER	2000-05			CD-7714	Each	1
	1996-99			CD-7720	Each	1
	1991-95			CD-7719	Each	1
DRYER	2000-05			DR-7909	Each	1
	1996-99			DR-7908	Each	1
	1991-95			DR-7908	Each	1
PONTIAC SPORT UTILITY						
AZTEK						
ALL						
AIR SHOCK - REAR	2001-05	Rear		AS-7404	Each	2
PONTIAC VAN						
MONTANA						
ALL						
AIR SHOCK - REAR	2004-05	Rear		AS-7404	Each	2
	1999-03	Rear		AS-7404	Each	2
AIR SHOCK - REAR	2006-09	Rear	w/o Independent Rear Susp.	AS-7404	Each	2
COMPRESSOR - DRYER	2004-05			CD-7712	Each	1
	1999-03			CD-7712	Each	1
TRANS SPORT						
ALL						
AIR SHOCK - REAR	1997-99	Rear		AS-7404	Each	2
AIR-COIL SPRING CONVERSION KT [REAR]	1990-96	Rear		CK-7603	Kit	1
COMPRESSOR - DRYER	1997-99			CD-7712	Each	1
PORSCHE						
PANAMERA						
ALL						
AIR COMPRESSOR	2010-16		Exc. Hybrid	CD-7755	Each	1
AIR SPRING-REAR	2010-16	Rear		AS-7083	Each	2
CONTROL VALVE	2010-16			CV-0005	Each	1
PORSCHE SUV						
CAYENNE						
ALL						
AIR COMPRESSOR	2011-16			CD-7754	Each	1
	2003-06			CD-7723	Each	1
AIR SPRING-FRONT LEFT	2008-10	Front Left		AS-7043	Each	1
	2003-06	Front Left		AS-7043	Each	1
AIR SPRING-FRONT RIGHT	2008-10	Front Right		AS-7044	Each	1

Air Spring Suspension

Part Type	Year	Location	Description	Part No.	Std Pack	Qty/Car
PORSCHE SUV (continued)						
CAYENNE (continued)						
ALL						
AIR SPRING-FRONT RIGHT	2008-10	Front Right		AS-7355	Each	1
	2003-06	Front Right		AS-7044	Each	1
AIR SPRING-REAR LEFT	2008-10	Rear Left		AS-7045	Each	1
	2003-06	Rear Left		AS-7045	Each	1
AIR SPRING-REAR RIGHT	2008-10	Rear Right		AS-7046	Each	1
	2003-06	Rear Right		AS-7046	Each	1
AIR STRUT - FRONT LEFT	2011-16	Front Left		AS-7381	Each	1
	2008-10	Front Left		AS-7354	Each	1
AIR STRUT - FRONT RIGHT	2011-16	Front Right		AS-7382	Each	1
AIR STRUT - REAR LEFT	2011-16	Rear Left		AS-7383	Each	1
	2008-10	Rear Left		AS-7356	Each	1
	2003-06	Rear Left		AS-7356	Each	1
AIR STRUT - REAR RIGHT	2011-16	Rear Right		AS-7384	Each	1
	2008-10	Rear Right		AS-7357	Each	1
	2003-06	Rear Right		AS-7357	Each	1
AIR-COIL SPRING CONV KT [FRONT & REAR]	2008-10	Front and Rear	Suspension Light Removal Tool Not Included	CK-7873	Kit	1
	2003-06	Front and Rear	Suspension Light Removal Tool Not Included	CK-7873	Kit	1
COMPRESSOR - DRYER	2008-10			CD-7723	Each	1
CONTROL VALVE	2011-16			CV-0005	Each	1
	2008-10			CV-0005	Each	1
	2003-06			CV-0005	Each	1
MACAN						
ALL						
AIR SPRING-REAR LEFT	2015-17	Rear Left		AS-7081	Each	1
AIR SPRING-REAR RIGHT	2015-17	Rear Right		AS-7082	Each	1
RAM TRUCK						
1500 PICKUP						
ALL						
AIR COMPRESSOR	2013-19			CD-7757	Each	1
AIR SPRING-REAR	2013-19	Rear		AS-7063	Each	2
AIR STRUT - FRONT	2013-19	Front		AS-7392	Each	2
CONTROL VALVE	2013-19			CV-0005	Each	1
3500 PICKUP						
ALL						
CONTROL VALVE	2013-18			CV-0005	Each	1
SAAB SUV						
9-7X						
ALL						
AIR SPRING-REAR	2005-09	Rear		AS-7056	Each	2
AIR-COIL SPRING CONVERSION KT [REAR]	2005-09	Rear	Springs & Adapters	CK-7626	Kit	1
		Rear	Incl. Rear Springs & Shocks	CK-7626WS	Kit	1
SATURN VAN						
RELAY						
ALL						
AIR SHOCK - REAR	2005-07	Rear	w/o Independent Rear Susp.	AS-7404	Each	2
COMPRESSOR - DRYER	2005-07			CD-7712	Each	1

Air Spring Suspension

Part Type	Year	Location	Description	Part No.	Std Pack	Qty/Car
TESLA						
S						
ALL						
AIR COMPRESSOR	2012-15			CD-7757	Each	1
AIR STRUT - FRONT	2012-15	Front		AS-7378	Each	2
AIR STRUT - REAR LEFT	2012-15	Rear Left		AS-7379	Each	1
AIR STRUT - REAR RIGHT	2012-15	Rear Right		AS-7380	Each	1
CONTROL VALVE	2012-15			CV-0005	Each	1
TOYOTA SPORT UTILITY						
4RUNNER						
ALL						
AIR COMPRESSOR	2003-11			CD-7751	Each	1
AIR SPRING-REAR LEFT	2003-11	Rear Left	w/ Rear Air Spring Suspension	AS-7037	Each	1
AIR SPRING-REAR RIGHT	2003-11	Rear Right	w/ Rear Air Spring Suspension	AS-7038	Each	1
AIR-COIL SPRING CONVERSION KT [REAR]	2003-11	Rear		CK-7866	Kit	1
DRYER	2003-11			DR-7914	Each	1
SEQUOIA						
ALL						
AIR COMPRESSOR	2008-19			CD-7767	EA	1
	2007			CD-7769	EA	1
	2005-06			CD-7768	EA	1
VOLKSWAGEN PASSENGER CAR						
PHAETON						
ALL						
AIR COMPRESSOR	2004-06			CD-7744	Each	1
AIR STRUT - FRONT LEFT	2004-06	Front Left		AS-7362	Each	1
AIR STRUT - FRONT RIGHT	2004-06	Front Right		AS-7363	Each	1
AIR STRUT - REAR LEFT	2004-06	Rear Left		AS-7338	Each	1
AIR STRUT - REAR RIGHT	2004-06	Rear Right		AS-7339	Each	1
VOLKSWAGEN SPORT UTILITY						
TOUAREG						
ALL						
AIR COMPRESSOR	2011-16			CD-7754	Each	1
AIR SPRING-FRONT LEFT	2007-10	Front Left		AS-7043	Each	1
	2004-06	Front Left		AS-7043	Each	1
AIR SPRING-FRONT RIGHT	2007-10	Front Right		AS-7044	Each	1
	2004-06	Front Right		AS-7044	Each	1
AIR SPRING-REAR LEFT	2007-10	Rear Left		AS-7045	Each	1
	2004-06	Rear Left		AS-7045	Each	1
AIR SPRING-REAR RIGHT	2007-10	Rear Right		AS-7046	Each	1
	2004-06	Rear Right		AS-7046	Each	1
AIR STRUT - FRONT LEFT	2011-16	Front Left		AS-7381	Each	1
	2007-10	Front Left	w/ Standard Suspension	AS-7354	Each	1
	2004-06	Front Left		AS-7354	Each	1
AIR STRUT - FRONT RIGHT	2011-16	Front Right		AS-7382	Each	1
	2007-10	Front Right	w/ Standard Suspension	AS-7355	Each	1
	2004-06	Front Right		AS-7355	Each	1
AIR STRUT - REAR LEFT	2011-16	Rear Left		AS-7383	Each	1
	2007-10	Rear Left		AS-7356	Each	1
	2004-06	Rear Left		AS-7356	Each	1
AIR STRUT - REAR RIGHT	2011-16	Rear Right		AS-7384	Each	1
	2007-10	Rear Right		AS-7357	Each	1
	2004-06	Rear Right		AS-7357	Each	1
AIR-COIL SPRING CONV KT [FRONT & REAR]	2007-10	Front and Rear		CK-7873	Kit	1

Air Spring Suspension

Part Type	Year	Location	Description	Part No.	Std Pack	Qty/Car
VOLKSWAGEN SPORT UTILITY (continued)						
TOUAREG (continued)						
ALL						
AIR-COIL SPRING CONV KT [FRONT & REAR]	2004-06	Front and Rear		CK-7873	Kit	1
COMPRESSOR - DRYER	2007-10			CD-7723	Each	1
	2004-06			CD-7723	Each	1
CONTROL VALVE	2011-16			CV-0005	Each	1
	2007-10			CV-0005	Each	1
	2004-06			CV-0005	Each	1
VOLVO PASSENGER CAR						
S90						
ALL						
AIR COMPRESSOR	2017-19			CD-7762	Each	1
AIR SPRING-REAR	2017-19	Rear		AS-7065	Each	2
V90						
ALL						
AIR COMPRESSOR	2018-19			CD-7762	Each	1
AIR SPRING-REAR	2018-19	Rear		AS-7065	Each	2
V90 CROSS COUNTRY						
ALL						
AIR COMPRESSOR	2017-19			CD-7762	Each	1
AIR SPRING-REAR	2017-19	Rear		AS-7065	Each	2
VOLVO SPORT UTILITY						
XC60						
ALL						
AIR COMPRESSOR	2018-20			CD-7762	Each	1
AIR SPRING-REAR	2018-20	Rear		AS-7065	Each	2
AIR STRUT - FRONT LEFT	2018-20	Front Left		AS-37102	Each	1
AIR STRUT - FRONT RIGHT	2018-20	Front Right		AS-37103	Each	1
CONTROL VALVE	2018-20			CV-0005	Each	1
XC90						
ALL						
AIR COMPRESSOR	2016-19			CD-7762	Each	1
AIR SPRING-REAR	2016-19	Rear		AS-7065	Each	2
AIR STRUT - FRONT LEFT	2016-19	Front Left		AS-37102	Each	1
AIR STRUT - FRONT RIGHT	2016-19	Front Right		AS-37103	Each	1
CONTROL VALVE	2016-19			CV-0005	Each	1

MEDIUM DUTY TRUCK



AS-7900

1996-2003 Mercedes Benz V-Class
Vito / Viano



AS-7901

2004-2013 Mercedes Benz V-Class
Vito / Viano

UNIVERSAL COMPONENTS



AS-7902

Diameter: 6.25"
Closed: 2.8"
Extended: 8.50"
Rate: 2,000 lbs @ 550 psi



AS-7903

Diameter: 7.25"
Closed: 2.8"
Extended: 10.50"
Rate: 3,000 lbs @ 500psi



AS-7904

Diameter: 4.50"
Closed: 5.75"
Extended: 12.75"
Rate: 2,500 lb per axle @ 150 psi



AS-7905

Diameter: 5.70"
Closed: 4.30"
Extended: 8.30"
Rate: 1,500 lb per axle @ 150 psi



CD-7900

Weight: 11 lbs.
Height: 6"
Length: 10"
CFM: 2.5
HP: 1/3hp
AMPS: 15



AIR TANKS

AT-1GAL : 1 Gallon Tank
AT-3GAL : 3 Gallon Tank
AT-5GAL : 5 Gallon Tank

Suspension Strut Mounts

Model	Years	Location/ Options	Front	Rear
ACURA PASSENGER CAR				
CL	2001-03	Lower Spring Isolator	ST-1940	ST-1961
		Lower Bushing		ST-6949
	1997-99	Lower Spring Isolator	ST-1940	ST-1961
		Lower Bushing		ST-6949
CSX	2006-11		ST-6964	
			ST-7957	
EL	2001-05	Left Side	ST-6920	
		Right Side	ST-6919	
	1997-00			ST-1940
ILX	2013-18		ST-6964	
INTEGRA	1994-01	exc. Type R	ST-1940	ST-1940
		Lower Bushing		ST-6916
	1990-93	Lower Bushing	ST-1940	ST-1940
				ST-6916
LEGEND	1991-95	Lower Bushing	ST-1939	ST-1961
				ST-6915
	1989-90	Coupe	ST-2928	ST-2991
		Sedan, exc Auto Leveling	ST-1940	ST-1961
1987-88	Lower Bushing		ST-6915	
	Coupe	ST-1940	ST-1961	
	Sedan	ST-1940	ST-2967	
1986	Lower Bushing		ST-6915	
	1986	Sedan	ST-1940	ST-2967
NSX	1991-01		ST-1940	ST-1940
RL	1996-04	incl. Type S	ST-4976	ST-4977
		Lower Spring Isolator	ST-7958	ST-7968
RSX	2005-06	Left Side, exc Type S	ST-6920	ST-1940
		Left Side, incl. Type S	ST-4997	ST-1940
		Right Side, exc Type S	ST-6919	ST-1940
		Right Side, incl. Type S	ST-4996	ST-1940
	2002-04	Left Side	ST-6920	
		Right Side	ST-6919	
				ST-1940
TL	2009-14	Upper Spring Isolator	ST-1940	ST-1940
		Lower Spring Isolator	ST-9922	
			ST-6950	
	2004-08	Lower Spring Isolator	ST-1940	ST-1940
			ST-6950	ST-6951
	1999-03	Lower Spring Isolator	ST-1940	ST-1940
				ST-6949
1995-98	Lower Spring Isolator	ST-1940	ST-1961	
		ST-7958		
TLX	2015-17			ST-9912
TSX	2009-14	Stud Plate; Left Side	ST-9917	
		Stud Plate; Right Side	ST-9918	
		Upper Spring Isolator	ST-9922	
	2004-08	Lower Spring Isolator	ST-1940	ST-1940
		ST-6950	ST-6951	
VIGOR	1992-94		ST-1940	ST-1961

Suspension Strut Mounts

Model	Years	Location/ Options	Front	Rear
ACURA SPORT UTILITY				
MDX	2007-13		ST-7983	
	2001-06		ST-4975	
RDX	2007-12		ST-6966	
AUDI PASSENGER CAR				
80	1988-92		ST-1942	
80 QUATTRO	1988-92		ST-1942	
90	1993-95		ST-1942	
	1988-91		ST-1942	
90 QUATTRO	1993-95		ST-1942	
	1988-91		ST-1942	
100	1992-94	Sedan, exc. Sport Susp.	ST-3912	ST-3913
	1991	Sedan, exc. Sport Susp.	ST-1985	ST-3913
	1989-90		ST-1985	ST-3913
100 QUATTRO	1992-94	Sedan, exc. Sport Susp.	ST-3912	
		Sedan & Wagon, exc Sport Susp.		ST-3913
	1989-91	Sedan, exc. Sport Susp.	ST-1985	ST-3913
200	1989-91	Sedan	ST-1985	ST-3913
200 QUATTRO	1989-91	Sedan & Wagon	ST-1985	ST-3913
4000	1980-87		ST-1942	
4000 QUATTRO	1984-87		ST-1942	
5000	1980-88	Sedan	ST-1985	
	1978-79		ST-2925	
5000 QUATTRO	1986-88		ST-1985	
A3	2008-13	w/o Magnetic Ride Control Suspension	ST-7949	
		w/o Magnetic Ride Control Suspension; w/ Oval Jounce Bumper		ST-8923
		w/o Magnetic Ride Control Suspension; w/ Round Jounce Bumper		ST-7947
	2006-07	w/o Magnetic Ride Control Suspension	ST-7949	ST-7947
A3 QUATTRO	2008-13	w/o Magnetic Ride Control Suspension	ST-7949	
		w/o Magnetic Ride Control Suspension; w/ Oval Jounce Bumper		ST-8923
		w/o Magnetic Ride Control Suspension; w/ Round Jounce Bumper		ST-7947
	2006-07	w/o Magnetic Ride Control Suspension	ST-7949	ST-7947
A4	2009-15	w/ Active Dampening System	ST-10012	
				ST-10008
	2007		ST-4992	
	2006	Sedan	ST-4908	ST-4907
	1996-05	Sedan & Wagon, incl. Sport Susp.	ST-4908	ST-4907
A4 QUATTRO	2009-15	w/ Active Dampening System	ST-10012	
				ST-10008
	2001-07	Sedan & Wagon, incl. Sport Susp.	ST-4908	ST-4965
	1996-00	Sedan & Wagon, incl. Sport Susp.	ST-4908	
A5	2009-15	w/ Active Dampening System	ST-10012	
				ST-10008
A5 QUATTRO	2009-15	w/ Active Dampening System	ST-10012	
				ST-10008
A6	2006-11	Exc. Air Suspension	ST-10003	
	1998-04		ST-4908	ST-4909
	1997	After 7/97	ST-4908	ST-4909
		Before 7/97	ST-3912	ST-4913
	1995-96	Before 7/97	ST-3912	ST-4913
A6 QUATTRO	2005-11	Exc. Air Suspension	ST-10003	
	1998-04		ST-4908	ST-9907
	1997	After 7/97	ST-4908	ST-9907
		Before 7/97	ST-3912	ST-4913

Suspension Strut Mounts

Model	Years	Location/ Options	Front	Rear
AUDI PASSENGER CAR (continued)				
A8 QUATTRO	1997-03		ST-4908	
A8	1997-00		ST-4908	
ALLROAD	2013-15			ST-10008
ALLROAD QUATTRO	2001-05		ST-4908	
CABRIOLET	1994-98	Convertible	ST-1942	
COUPE	1981-87		ST-1942	
COUPE QUATTRO	1990-91		ST-1942	
FOX	1973-79	Sedan & Wagon	ST-1903	
QUATTRO	1984-86		ST-1985	
RS5	2013-15			ST-10008
S4	2010-15	w/ Active Dampening System	ST-10012	
	1992-94		ST-1985	ST-10008
S5	2008-15	w/ Active Dampening System	ST-10012	
				ST-10008
S6	2008-11	Exc. Air Suspension	ST-10003	
	2002-03		ST-4908	
	1995-97		ST-3912	ST-3913
TT	2008-14		ST-7949	ST-8923
	2000-06		ST-4905	ST-4910
TT QUATTRO	2008-15		ST-7949	ST-8923
	2000-06		ST-4905	ST-4910
V8 QUATTRO	1992-94		ST-3912	
	1990-91		ST-1985	
AUDI SPORTS UTILITY				
Q5	2009-15	w/ Electronic Shocks	ST-10012	ST-10008
BMW PASSENGER CAR				
1 SERIES M	2011	REAR		
128I	2008-13	REAR:w/o Electronic Suspension	ST-7984	
		exc Sport Suspension	ST-3918	
		Lower Spring Isolator: exc. Sport Suspension	ST-7967	
135I	2008-13	REAR:w/o Electronic Suspension	ST-7984	
		exc Sport Suspension	ST-3918	
		Lower Spring Isolator: exc. Sport Suspension	ST-7967	
135IS	2013	REAR		
318I	1993-98		ST-2905	ST-1965
		Lower Spring Isolator	ST-6944	
	1992	After 6/92	ST-2905	
		Before 6/92	ST-2904	
		Lower Spring Isolator	ST-6944	ST-1965
	1991		ST-2904	ST-1965
1984-85		ST-2904	ST-1965	
318IS	1993-98		ST-2905	ST-1965
		Lower Spring Isolator	ST-6944	
	1992	After 6/92	ST-2905	
		Before 6/92	ST-2904	
		Lower Spring Isolator	ST-6944	ST-1965
1991		ST-2904	ST-1965	
318TI	1995-99		ST-2905	ST-1965
		Lower Spring Isolator	ST-6944	
320I	2001-05		ST-3918	
	1993-95		ST-2905	ST-1965
		Lower Spring Isolator	ST-6944	
1977-83		exc HD Suspension	ST-2903	

Suspension Strut Mounts

Model	Years	Location/ Options	Front	Rear
BMW PASSENGER CAR (continued)				
323CI	2000		ST-3918	ST-4966
323I	1999-00		ST-3918	
		Lower Spring Isolator	ST-6944	
323IS	1998		ST-2905	ST-1965
		Lower Spring Isolator	ST-6944	
323IS	1998-99		ST-2905	ST-1965
		Lower Spring Isolator	ST-6944	
325	1987-88		ST-2904	ST-1965
325CI	2001-06		ST-3918	ST-4966
		Upper Spring Isolator: RWD	ST-7974	
		Upper Spring Seat: RWD	ST-7973	
		Lower Spring Isolator: RWD	ST-7975	
325E	1984-87		ST-2904	ST-1965
325ES	1986-87		ST-2904	ST-1965
325I	2001-06		ST-3918	ST-4966
		Upper Spring Isolator: RWD	ST-7974	
		Upper Spring Seat: RWD	ST-7973	
	1992-95		ST-2905	ST-1965
		Lower Spring Isolator	ST-6944	
	1991	after 12/90 exc Sport Suspension	ST-2905	
		before 12/90 w/ Sport Suspension	ST-2904	
			ST-1965	
1987-90		ST-2904	ST-1965	
325IC	1993-95		ST-2905	ST-1965
	1987-92		ST-2904	ST-1965
325IS	1992-95		ST-2905	ST-1965
		Lower Spring Isolator	ST-6944	
	1991	after 12/90 exc Sport Suspension	ST-2905	
		before 12/90 w/ Sport Suspension	ST-2904	
			ST-1965	
1987-90		ST-2904	ST-1965	
325IX	1988-91	E30 w/ 4WD		ST-1965
325XI	2001-06		ST-3918	ST-4966
328CI	2000		ST-3918	ST-4966
328I	2007-13	REAR:w/o Electronic Suspension	ST-7984	
		exc Sport Suspension	ST-3918	
		Lower Spring Isolator: exc. Sport Suspension	ST-7967	
	1999-00		ST-3918	ST-1965
	1996-98		ST-2905	ST-1965
Lower Spring Isolator		ST-6944		
328IC	1996-98		ST-2905	ST-1965
328I XDRIVE	2009-13	REAR		
328XI	2007-08	REAR		
328IS	1996-98		ST-2905	ST-1965
		Lower Spring Isolator	ST-6944	
330CI	2001-06		ST-3918	
330I	2001-06		ST-3918	
335D	2009-11	REAR		
335I	2007-13	REAR:w/o Electronic Suspension	ST-7984	
		exc Sport Suspension	ST-3918	
		Lower Spring Isolator: exc. Sport Suspension	ST-7967	
335I XDRIVE	2009-13	REAR		
335IS	2011-13	REAR		
335XI	2007-08	REAR		
525XI	2006-07			ST-9908
525I	2004-07			ST-9908
	2001-03		ST-3918	
		Sedan		ST-3921

Suspension Strut Mounts

Model	Years	Location/ Options	Front	Rear
BMW PASSENGER CAR (continued)				
525I	2001-03	Wagon		ST-10009
	1989-95		ST-2904	ST-3915
525IT	1993	exc elec adj suspension	ST-2904	ST-3915
528E	1982-88		ST-2904	
528I	2008-10			ST-9908
	1999-00	Exc Elec Adj Suspension	ST-3918	
		Sedan, exc Active Suspension		ST-3921
		Wagon; exc. Electronic Suspension		ST-10009
	1998	Exc Elec Adj Suspension	ST-3918	
		Sedan, exc Active Suspension		ST-3921
	1996	Exc Elec Adj Suspension	ST-3918	ST-3921
528XI	2008			ST-9908
530I	2001-03	exc elec adj suspension	ST-3918	ST-3921
	1994-95	exc elec adj suspension	ST-2904	ST-3915
530XI	2006-07			ST-9908
533I	1983-84		ST-2904	
535I	1988-93	Exc Elec Adj Suspension	ST-2904	ST-3915
	1985-87		ST-2904	
535I GT	2011-17			ST-9908
535I XDRIVE	2011-15			ST-9908
535IS	1988	exc M5 or elec adj suspension	ST-2904	ST-3915
535XI	2008			ST-9908
540I	1999-03	exc elec adj suspension	ST-3919	
		Sedan, exc Active Suspension		ST-3921
		Wagon; exc. Electronic Suspension		ST-10008
	1997-98	exc elec adj suspension	ST-3919	ST-3921
	1994-95	E34 exc Sport Suspension	ST-2904	ST-3915
545I	2004-06			ST-9908
550I	2006-10			ST-9908
550I GT	2010-15			ST-9908
635CSI	1985-89	exc elec adj suspension	ST-2904	
645CI	2004-05			ST-9908
650I	2006-08		ST-3918	ST-9908
735I	1986-92	exc elec adj suspension		ST-2956
735IL	1988-92	exc elec adj suspension		ST-2956
740I	1997-01	exc elec adj suspension	ST-3922	ST-3920
		Lower Spring Isolator	ST-6953	
	1995	exc elec adj suspension	ST-3922	ST-3920
		Lower Spring Isolator	ST-6953	
	1993-94	E38 exc elec adj susp	ST-3922	ST-3920
		E32 exc elec adj susp		ST-2956
740IL	1995-01	exc elec adj suspension	ST-3922	ST-3920
		Lower Spring Isolator	ST-6953	
	1993-94	E38 exc elec adj susp	ST-3922	ST-3920
		E32 exc elec adj susp		ST-2956
750IL	1994-01	exc elec adj suspension	ST-3922	
		Lower Spring Isolator	ST-6953	
M3	2008-13	REAR;w/o Electronic Suspension	ST-7984	
		exc Sport Suspension	ST-3918	
		Lower Spring Isolator; exc. Sport Suspension	ST-7967	
	2001-05			ST-4966
	1995-99	Left Side	ST-3917	
		Right Side	ST-3916	
	1988-91		ST-2904	ST-1965
M5	2000-03		ST-3919	ST-3920
	1991-93		ST-2904	
	1988		ST-2904	
Z3	1996-02	exc sport suspension	ST-2905	ST-1965

Suspension Strut Mounts

Model	Years	Location/ Options	Front	Rear	
BMW PASSENGER CAR (continued)					
Z4	2003-06	exc M Series	ST-5905		
BMW SPORT UTILITY					
X1	2016-18	Bushing Kit			
		Bushing Kit		ST-8911	
	2013-15	REAR			
X3	2011-17		ST-10027		
	2004-10		ST-3918		
		Stud Plate Only		ST-8992	
X4	2015-17		ST-10027		
X5	2007-13	Exc. M Model	ST-10000		
	2006		ST-3914		
	2000-05		ST-3914	ST-3923	
X6	2008-14	Exc. M Model	ST-10000		
BUICK PASSENGER CAR					
ALLURE	2005-09		ST-2973		
		Left Side		ST-2969	
		Right Side		ST-2968	
CASCADA	2016-19		ST-10004		
CENTURY	1997-05	Left Side	ST-2973	ST-2969	
		Right Side	ST-2973	ST-2968	
		Upper Spring Isolator	ST-4942		
		Lower Spring Isolator	ST-4943	ST-4941	
	1984-96		ST-1934	ST-1951	
		Upper Spring Seat & Isolator	ST-3971		
1982-83		ST-1934			
ELECTRA	1985-90		ST-1973	ST-1953	
		Bearing Only	ST-1928		
		Upper Spring Seat & Isolator	ST-3974		
		Lower Spring Isolator	ST-4923		
LACROSSE	2010-16	Exc Elec Adj Suspension	ST-7987		
	2005-09	exc w/ 17" or 18" wheels	ST-2973		
		Left Side, exc w/ 17" or 18" wheels		ST-2969	
		Right Side, exc w/ 17" or 18" wheels		ST-2968	
LESABRE	2000-05		ST-2972	ST-2998	
	1991-99	late Design w/o Spring guard	ST-1922	ST-1953	
		Upper Spring Seat & Isolator	ST-3973		
		Lower Spring Isolator	ST-4925		
		1990	early Design w/ Spring guard	ST-1973	
			late Design w/o Spring guard	ST-1922	
					ST-1953
			Bearing Only	ST-1928	
	Upper Spr Seat & Iso w/o Spr Guard exc Auto Level	ST-3973			
	Upper Spr Seat & Iso w/o Spr Guard w/ Auto Level	ST-3972			
	Upper Spr Seat & Isolator w/ Spring GUARD	ST-3974			
	Lower Spring Isolator: w/ Spring Guard	ST-4923			
	Lower Spring Isolator: w/o Spring Guard	ST-4925			
	1986-89		ST-1973	ST-1953	
Bearing Only		ST-1928			
Upper Spring Seat & Isolator		ST-3974			
		Lower Spring Isolator	ST-4923		
LUCERNE	2006-11		ST-8948	ST-2998	
		Lower Spring Isolator	ST-9901		
PARK AVENUE	1998-05	exc elec adj suspension	ST-2972	ST-2998	
	1997	exc elec adj suspension	ST-2930	ST-2998	
	1991-96		ST-1922	ST-1953	

Suspension Strut Mounts

Model	Years	Location/ Options	Front	Rear
BUICK PASSENGER CAR (continued)				
PARK AVENUE	1991-96	Bearing Only	ST-1928	
		Upper Spring Seat & Isolator	ST-3973	
		Lower Spring Isolator	ST-4925	
REATTA	1990-91		ST-2965	ST-2971
	1988-89		ST-1990	ST-2971
REGAL	2017		ST-7987	
	2015-16		ST-7987	
	2013-14		ST-7987	
		Exc. Active Suspension; Left Side		
	2011-12	exc Active Suspension	ST-7991	
	1997-04	Left Side; w/ FWD	ST-2973	ST-2969
		Right Side; w/ FWD	ST-2973	ST-2968
		Upper Spring Isolator	ST-4942	
		Lower Spring Isolator	ST-4943	ST-4941
	1988-96	w/ FWD	ST-1921	ST-2941
Lower Spring Seat & Bearing; Left Side; w/ FWD		ST-2994		
Lower Spring Seat & Bearing; Ride Side; w/ FWD		ST-2995		
RIVIERA	1998-99		ST-2972	ST-2998
	1995-97		ST-2930	ST-2998
		Upper Spring Seat & Isolator	ST-3973	
	1990-93		ST-2965	ST-2971
	1986-89		ST-1990	ST-2971
SKYHAWK	1984-89		ST-1913	ST-1951
		Upper Spring Seat & Isolator	ST-3969	
		Lower Spring Isolator	ST-4924	
	1983		ST-1913	
		Upper Spring Seat & Isolator	ST-3969	
	1982		ST-4924	
			ST-1913	
		Upper Spring Seat & Isolator	ST-3969	
SKYLARK	1995-98	exc elec suspension	ST-4912	ST-1951
		Upper Spring Seat & Isolator	ST-3970	
	1992-94		ST-1946	ST-1951
		Upper Spring Seat & Isolator	ST-3972	
	1986-91		ST-1913	ST-1951
		Upper Spring Seat & Isolator	ST-3969	
	1984-85	Lower Spring Isolator	ST-4924	
Upper Spring Seat & Isolator		ST-1934	ST-1951	
1982-83		ST-3971		
		ST-1934		
		ST-1934		
SOMERSET	1985-87		ST-1913	ST-1951
		Upper Spring Seat & Isolator	ST-3969	
		Lower Spring Isolator	ST-4924	
VERANO	2012-17		ST-10004	
BUICK SPORT UTILITY				
ENCLAVE	2008-16		ST-7986	
		Upper Spring Isolator	ST-9923	
		Lower Spring Isolator	ST-9924	
ENCORE	2013-19		ST-10004	
RAINIER	2004-07		ST-4968	
RENDEZVOUS	2002-07		ST-2973	
		Upper Spring Isolator	ST-4942	
		Lower Spring Isolator	ST-4943	

Suspension Strut Mounts

Model	Years	Location/ Options	Front	Rear
BUICK VAN				
TERRAZA	2005-07		ST-2973	
		Upper Spring Isolator	ST-4942	
		Lower Spring Isolator	ST-4943	
CADILLAC PASSENGER CAR				
ALLANTE	1987-92	exc elec suspension	ST-2965	ST-2971
ATS	2016			ST-9910
	2013-15		ST-9909	ST-9910
CTS	2014-16	w/o Electronic Suspension	ST-9909	
	2003	FE3 (Soft Ride Suspension)		ST-8991
CATERA	1997-01		ST-3932	
CIMARRON	1984-88		ST-1913	ST-1951
		Upper Spring Seat & Isolator	ST-3969	
		Lower Spring Isolator	ST-4924	
	1983		ST-1913	
		Upper Spring Seat & Isolator	ST-3969	
		Lower Spring Isolator	ST-4924	
	1982		ST-1913	
	Upper Spring Seat & Isolator	ST-3969		
DTS	2006-11		ST-8948	ST-2998
		Lower Spring Isolator	ST-9901	
DEVILLE	2000-05		ST-2972	ST-2998
	1994-99		ST-2965	ST-3929
	1991-93	w/ FWD	ST-1922	ST-1953
		Bearing Only	ST-1928	
		w/ FWD - Upper Spring Seat & Isolator	ST-3973	
		w/ FWD & CCR - Lower Spring Isolator	ST-4925	
	1987-90	w/ FWD	ST-1973	ST-1953
		Bearing Only	ST-1928	
		w/ FWD - Upper Spring Seat & Isolator	ST-3974	
		Lower Spring Isolator; w/ FWD	ST-4923	
1985-86	w/ FWD	ST-1991	ST-1953	
	Lower Spring Isolator; w/ FWD	ST-4923		
ELDORADO	1994-02		ST-2965	ST-3929
		Bearing Only	ST-1928	
	1987-93		ST-2965	ST-2971
		Bearing Only	ST-1928	
	1986		ST-1990	ST-2971
ELR	2014-16	REAR		
FLEETWOOD	1991-93		ST-1922	ST-1953
		Bearing Only	ST-1928	
		w/o CCR - Upper Spring Seat & Isolator	ST-3973	
		w/o CCR - Lower Spring Isolator	ST-4925	
	1987-90	FWD	ST-1973	ST-1953
		w/ FWD - Upper Spring Seat & Isolator	ST-3974	
		Lower Spring Isolator; w/ FWD	ST-4923	
	1985-86	w/ FWD	ST-1991	ST-1953
		w/ FWD - Upper Spring Seat & Isolator	ST-3974	
		Lower Spring Isolator; w/ FWD	ST-4923	
SEVILLE	1998-04	Exc Elec Adj Suspension	ST-2972	ST-2998
	1994-97		ST-3930	ST-3929
		Bearing Only	ST-1928	
	1987-93		ST-2965	ST-2971
		Bearing Only	ST-1928	
	1986		ST-1990	ST-2971

Suspension Strut Mounts

Model	Years	Location/ Options	Front	Rear
CADILLAC SPORT UTILITY				
SRX	2010-16		ST-10031	
ESCALADE	2007-14	2WD & 4WD, exc Z55 and ZW7 Suspension	ST-5910	
		Upper Spring Isolator	ST-7942	
ESCALADE ESV	2007-14	2WD & 4WD, exc Z55 and ZW7 Suspension	ST-5910	
		Upper Spring Isolator	ST-7942	
ESCALADE EXT	2007-13	2WD & 4WD, exc Z55 and ZW7 Suspension	ST-5910	
		Upper Spring Isolator	ST-7942	
CHEVROLET PASSENGER CAR				
AVEO5	2007-08		ST-5906	ST-5981
AVEO	2004-11		ST-5906	ST-5981
ASTRA (MEXICO)	2000-08		ST-98005	
BERETTA	1995-96		ST-4912	ST-1951
		Upper Spring Seat & Isolator	ST-3970	
	1992-94		ST-1946	ST-1951
		Upper Spring Seat & Isolator	ST-3972	
	1987-91		ST-1929	ST-1951
		Upper Spring Seat & Isolator	ST-3969	
		Lower Spring Isolator	ST-4924	
CAMARO	2010-13	exc Active Suspension	ST-7991	ST-7992
	1993-02	Left Side	ST-2947	
		Right Side	ST-2948	
		Upper Spring Isolator	ST-3933	
		Lower Spring Seat	ST-4962	
	1982-92	Left Side	ST-1924	
Right Side		ST-1923		
CAPRICE	2011-13			ST-7992
CAVALIER	2000-05		ST-4919	ST-2949
		Upper Spring Isolator	ST-4939	
		Lower Spring Isolator	ST-4940	
	1995-99		ST-4912	ST-2949
		Upper Spring Isolator	ST-4939	
		Lower Spring Isolator	ST-4940	
	1992-94		ST-1929	ST-1951
		Upper Spring Seat & Isolator	ST-3969	
	1984-91		ST-1913	ST-1951
		Upper Spring Seat & Isolator	ST-3969	
		Lower Spring Isolator	ST-4924	
	1983		ST-1913	
Upper Spring Seat & Isolator		ST-3969		
	Lower Spring Isolator	ST-4924		
1982		ST-1913		
	Upper Spring Seat & Isolator	ST-3969		
CELEBRITY	1984-90		ST-1934	ST-1951
		Upper Spring Seat & Isolator	ST-3971	
	1982-83		ST-1934	
CHEVY (MEXICO)	1994-12		ST-98003	
CITATION	1984-85		ST-1934	ST-1951
		Upper Spring Seat & Isolator	ST-3971	
	1982-83		ST-1934	
CLASSIC	2004-05		ST-2999	ST-3900
		Upper Spring Isolator	ST-4944	
		Lower Spring Isolator	ST-4945	
COBALT	2005-10		ST-5907	
		Upper Spring Isolator	ST-7909	
		Upper Spring Seat	ST-7908	
		Lower Spring Isolator	ST-7910	
CORSA (MEXICO)	2002-08		ST-98005	

Suspension Strut Mounts

Model	Years	Location/ Options	Front	Rear
CHEVROLET PASSENGER CAR (continued)				
CORSICA	1995-96	Upper Spring Seat & Isolator	ST-4912	ST-1951
			ST-3970	
	1994	Upper Spring Seat & Isolator	ST-1946	ST-1951
			ST-3970	
	1992-93	Upper Spring Seat & Isolator	ST-1946	ST-1951
		ST-3972		
1987-91	Upper Spring Seat & Isolator	ST-1929	ST-1951	
	Lower Spring Isolator	ST-3969		
		ST-4924		
CRUZE	2011-15		ST-10004	
CRUZE LIMITED	2016		ST-10004	
HHR	2006-11		ST-5907	
IMPALA	2015-20		ST-7987	
			ST-7987	
	2014	Left Side; Police		ST-2969
		Right Side; Police		ST-2968
	2000-13	Left Side, exc w/ 17" or 18" wheels	ST-2973	ST-2969
		Right Side, exc w/ 17" or 18" wheels	ST-2973	ST-2968
Upper Spr Iso, exc w/ 17" or 18" wheels		ST-4942		
Lower Spr Iso, exc w/ 17" or 18" wheels		ST-4943		
	Lower Spr Iso, exc 17" or 18" whl, Police or Taxi		ST-4941	
LUMINA	1995-01	Left Side	ST-1921	ST-2969
		Right Side	ST-1921	ST-2968
		Lower Spring Seat & Bearing - Left Side	ST-2994	
		Lower Spring Seat & Bearing - Right Side	ST-2995	
	1990-94	Lower Spring Seat & Bearing - Left Side	ST-1921	ST-2941
		Lower Spring Seat & Bearing - Right Side	ST-2994	
			ST-2995	
MALIBU	2013-20		ST-7987	
	2008-12	Left Side	ST-5909	
		Right Side	ST-5908	
				ST-7990
	2004-07	Left Side	ST-5909	
		Right Side	ST-5908	
		Hatchback		ST-7990
	1997-03	Upper Spring Isolator	ST-2999	ST-3900
		Lower Spring Isolator	ST-4944	
			ST-4945	
MALIBU LIMITED	2016		ST-7987	
MERIVA (MEXICO)	2004-08		ST-98005	
METRO	1998-01		ST-1987	ST-1988
MONTE CARLO	2000-07	Left Side, exc w/ 17" or 18" wheels	ST-2973	ST-2969
		Right Side, exc w/ 17" or 18" wheels	ST-2973	ST-2968
		Upper Spr Iso, exc w/ 17" or 18" wheels	ST-4942	
		Lower Spr Iso, exc w/ 17" or 18" wheels	ST-4943	ST-4941
	1995-99	Left Side	ST-1921	ST-2969
		Right Side	ST-1921	ST-2968
		Lower Spring Seat & Bearing - Left Side	ST-2994	
	Lower Spring Seat & Bearing - Right Side	ST-2995		
NOVA	1985-88	exc twin cam engine	ST-1943	ST-1958
PRIZM	1998-02		ST-5912	ST-2901
SPARK	2015-16	REAR		
SPECTRUM	1985-88		ST-1932	
SPRINT	1989-91		ST-1987	ST-1988
	1985-88		ST-2933	
VECTRA (MEXICAN VEH	2003-08		ST-98005	
VOLT	2011-15		ST-10004	

Suspension Strut Mounts

Model	Years	Location/ Options	Front	Rear
CHEVROLET SPORT UTILITY				
AVALANCHE	2007-13	2WD & 4WD, exc Z55 and ZW7 Suspension Upper Spring Isolator	ST-5910 ST-7942	
CAPTIVA SPORT	2012-15		ST-6956	
EQUINOX	2007-17		ST-6956	
	2005-06	Upper Spring Isolator	ST-5980 ST-8954	
BLAZER	1988-99	Torsion Bar Mount; w/ 4WD	ST-2992	
S10 BLAZER	1988-94	Torsion Bar Mount; w/ 4WD	ST-2992	
SUBURBAN 1500	2007-13	2WD & 4WD, exc Z55 and ZW7 Suspension Upper Spring Isolator	ST-5910 ST-7942	
TAHOE	2007-13	2WD & 4WD, exc Z55 and ZW7 Suspension Upper Spring Isolator	ST-5910 ST-7942	
TRACKER	1999-04	L4 2.0L & V6 2.5L,*	ST-4932	
	1999-02	L4 1.6L,*	ST-4933	
	1998		ST-1994	
	1989-91	exc ABS Brakes	ST-1994	
TRAILBLAZER	2002-09	2WD & 4WD	ST-4968	
TRAILBLAZER EXT	2002-06	2WD & 4WD	ST-4968	
TRAVERSE	2009-16	Upper Spring Isolator Lower Spring Isolator	ST-7986 ST-9923 ST-9924	
TRAX	2013-19		ST-10004	
CHEVROLET TRUCK				
COLORADO	2004-12	RWD	ST-9921	
S10 PICKUP	1988-99	Torsion Bar Mount; w/ 4WD	ST-2992	
SILVERADO 1500	2007-13	2WD & 4WD, exc Z55 and ZW7 Suspension Upper Spring Isolator	ST-5910 ST-7942	
SSR	2004-06	w/ Rear Coil Spring Suspension	ST-4968	
TORNADO (MEXICO)	2004-11	L4 1.8L 1796cc,*	ST-98005	
CHEVROLET VAN				
CITY EXPRESS	2015-18	Left Side Right Side Lower Spring Isolator	ST-8914 ST-8915 ST-9925	
LUMINA APV	1990-96	Upper Spring Seat & Isolator	ST-1934 ST-3971	ST-1951
UPLANDER	2005-09	Upper Spring Isolator Lower Spring Isolator	ST-2973 ST-4942 ST-4943	
VENTURE	1997-05	Upper Spring Isolator Lower Spring Isolator	ST-2973 ST-4942 ST-4943	
ZAFIRA (MEXICAN VEHI	2002-06		ST-98005	
CHRYSLER PASSENGER CAR				
200	2011-14	Upper Spring Isolator	ST-6958	ST-6959 ST-8943
300	2011-14	Bushing Kit RWD Stud Plate Only AWD	ST-5968 ST-6995 ST-5966 ST-5967	ST-8972 ST-8943 ST-5970
	2005-10	exc. NIVOMAT Rear Suspension RWD w/ NIVOMAT Rear Suspension AWD	ST-5968 ST-6995 ST-5966 ST-5967	ST-5970 ST-5969
300M	1999-04	Upper Spring Isolator Lower Spring Isolator	ST-3901 ST-5989 ST-5988	ST-3902 ST-5973 ST-5982

Suspension Strut Mounts

Model	Years	Location/ Options	Front	Rear
CHRYSLER PASSENGER CAR (continued)				
CIRRUS	1995-00		ST-1940	ST-2946
CONCORDE	1998-04	Upper Spring Isolator	ST-3901	ST-3902
		Lower Spring Isolator	ST-5989	ST-5973
	1993-97	Upper Spring Seat	ST-5988	ST-5982
		Lower Spring Isolator	ST-1980	ST-1978
CONQUEST	1987-89	exc adj suspension	ST-3977	
DAYTONA	1989-93	Upper Spring Seat	ST-5954	ST-5955
		Lower Spring Isolator	ST-2961	ST-2962
		Upper Spring Seat & Isolator	ST-1908	
	1987-88	Lower Spring Isolator	ST-4916	
		Upper Spring Seat & Isolator	ST-1908	
	1986	Lower Spring Isolator	ST-4916	
		after JAN 1	ST-3980	
		before JAN 1	ST-1908	
after JAN 1, Upper Spring Seat		ST-1907		
1984-85	after JAN 1, Lower Spring Isolator	ST-4916		
	Upper Spring Seat & Isolator	ST-3980		
DYNASTY	1988-93	Lower Spring Isolator	ST-1907	
		Upper Spring Seat & Isolator	ST-1908	
		Lower Spring Isolator	ST-4916	
E CLASS	1984		ST-3980	
	1983		ST-1907	
EXECUTIVE LIMOUSINE	1985		ST-1906	
EXECUTIVE SEDAN	1984		ST-1907	
	1983		ST-1907	
IMPERIAL	1990-93	exc full air suspension	ST-1906	
		Upper Spring Seat & Isolator	ST-1908	
		Lower Spring Isolator	ST-4916	
INTREPID	1998-04	Upper Spring Isolator	ST-3980	
		Lower Spring Isolator	ST-3901	ST-3902
		Upper Spring Isolator	ST-5989	ST-5973
	1993-97	Lower Spring Isolator	ST-5988	ST-5982
		Upper Spring Seat	ST-1980	ST-1978
LASER	1986	Upper Spring Seat	ST-3977	
		after JAN 1	ST-1908	
		before JAN 1	ST-1907	
		after JAN 1, Upper Spring Seat & Isolator	ST-4916	
	after Jan 1, Lower Spring Isolator	ST-3980		
1984-85		ST-1907		
LEBARON	1987-95	exc elec suspension	ST-1908	
		Upper Spring Seat & Isolator	ST-4916	
		Lower Spring Isolator	ST-3980	
	1986	after JAN 1	ST-1908	
		before JAN 1	ST-1907	
	1984-85		ST-1907	
	1983		ST-1906	
1982		ST-1905		
LHS	1999-01	Upper Spring Isolator	ST-3901	ST-3902
		Lower Spring Isolator	ST-5989	ST-5973
		Upper Spring Isolator	ST-5988	ST-5982
	1994-97	Lower Spring Isolator	ST-1980	ST-1978
		Upper Spring Seat	ST-3977	
NEON	2000-02	Upper Spring Seat	ST-3926	ST-3924
		Lower Spring Isolator	ST-5992	
NEW YORKER	1994-96	Upper Spring Seat	ST-1980	ST-1978
		Upper Spring Seat	ST-3977	
	1988-93		ST-1908	

Suspension Strut Mounts

Model	Years	Location/ Options	Front	Rear
CHRYSLER PASSENGER CAR (continued)				
NEW YORKER	1988-93	Upper Spring Seat & Isolator	ST-4916	
		Lower Spring Isolator	ST-3980	
	1987		ST-1908	
		Upper Spring Seat & Isolator	ST-4916	
	1986	after JAN 1	ST-1908	
		before JAN 1	ST-1907	
1984-85	after JAN 1, Upper Spring Seat & Isolator	ST-4916		
1983		ST-1907		
PT CRUISER	2001-09		ST-3926	
SEBRING	2007-10		ST-6958	
		Stud Plate Only		ST-8972
		Upper Spring Isolator		ST-8943
	2006	Bushing Kit		ST-6959
		Sedan & Convertible	ST-1940	
		Sedan & Convertible; Bushing Kit		ST-1940
		Sedan & Convertible	ST-1940	ST-1940
		Convertible		ST-6955
		Sedan		ST-6917
		Upper Spring Isolator		ST-7993
		Lower Spring Isolator; Conv. & Sedan		ST-7911
	2001-05	Lower Spring Isolator; Conv. & Sedan		ST-7911
		Coupe	ST-4957	
		Sedan & Convertible	ST-1940	
		Sedan & Convertible; Bushing Kit		ST-1940
		Bushing Kit; Coupe		ST-2923
		Convertible		ST-6955
		Sedan		ST-6917
		Stud Plate Only; Coupe		ST-9947
		Lower Spring Isolator; Coupe	ST-6938	
		Upper Spring Isolator; Convertible & Sedan		ST-7993
		Upper Spring Isolator; Coupe		ST-9969
	1996-00	Lower Spring Isolator; Conv. & Sedan		ST-7911
		Convertible	ST-1940	
		Convertible; Bushing Kit		ST-6957
		Convertible; Stud Plate Only		ST-7912
	1995-00	Upper Spring Isolator; Convertible		ST-7913
Coupe		ST-2923	ST-2923	
Upper Spring Isolator; Coupe			ST-7993	
TC MASERATI	1989-91		ST-1908	
		Upper Spring Seat & Isolator	ST-4916	
		Lower Spring Isolator	ST-3980	
CHRYSLER SUV				
PACIFICA	2004-08		ST-5911	
		Upper Spring Isolator	ST-8960	
		Upper Spring Seat	ST-8959	
		Lower Spring Isolator	ST-8958	
CHRYSLER VAN				
GRAND VOYAGER	2000		ST-2945	
		Upper Spring Seat	ST-3975	
		Lower Spring Isolator	ST-4921	
TOWN & COUNTRY	2008-15	exc. NIVOMAT Rear Suspension	ST-6960	
	2001-07		ST-5911	
		Upper Spring Isolator	ST-5972	
		Lower Spring Isolator	ST-5971	
	1996-00		ST-2945	
		Upper Spring Seat	ST-3975	

Suspension Strut Mounts

Model	Years	Location/ Options	Front	Rear
CHRYSLER VAN (continued)				
TOWN & COUNTRY	1996-00	Lower Spring Isolator	ST-4921	
	1995	after MAR 1	ST-2945	
		before MAR 1	ST-1908	
		after MAR 1, Upper Spring Seat & Isolator	ST-3975	
		before MAR 1, Upper Spring Seat & Isolator	ST-4916	
		after MAR 1, Lower Spring Isolator	ST-4921	
		before MAR 1, Lower Spring Isolator	ST-3980	
	1990-94			ST-1908
Upper Spring Seat & Isolator		ST-4916		
Lower Spring Isolator		ST-3980		
VOYAGER	2001-03		ST-5911	
		Upper Spring Isolator	ST-5972	
		Lower Spring Isolator	ST-5971	
	2000		ST-2945	
		Upper Spring Seat	ST-3975	
		Lower Spring Isolator	ST-4921	
DAIHATSU PASSENGER CAR				
CHARADE	1988-92			ST-3939
DODGE PASSENGER CAR				
400	1983		ST-1906	
	1982		ST-1905	
600	1987-88		ST-1908	
		Upper Spring Seat & Isolator	ST-4916	
		Lower Spring Isolator	ST-3980	
	1986	after JAN 1	ST-1908	
		before JAN 1	ST-1907	
		after JAN 1, Upper Spring Seat & Isolator	ST-4916	
	after JAN 1, Lower Spring Isolator	ST-3980		
	1984-85		ST-1907	
1983		ST-1906		
2000 GTX	1989-90	exc Auto leveling system		ST-2923
ARIES	1987-89		ST-1908	
		Upper Spring Seat & Isolator	ST-4916	
		Lower Spring Isolator	ST-3980	
	1986	after 1/86	ST-1908	
		before 1/86	ST-1907	
		after 1/86, Upper Spring Seat & Isolator	ST-4916	
	after 1/86, Lower Spring Isolator	ST-3980		
	1984-85		ST-1907	
1983		ST-1906		
1981-82		ST-1905		
ATOS (MEXICO)	2005-10		ST-98004	
AVENGER	2008-14		ST-6958	
		Stud Plate Only		ST-8972
		Upper Spring Isolator		ST-8943
	Bushing Kit		ST-6959	
	1995-00		ST-2923	ST-2923
		Upper Spring Isolator		ST-7993
CALIBER	2007-12		ST-7994	
		Stud Plate Only		ST-8972
		Upper Spring Isolator	ST-8970	ST-8973
		Upper Spring Seat	ST-8969	
		Lower Spring Isolator	ST-8971	
		Bushing Kit		ST-6959
CHALLENGER	2011-14	w/o Electronic Suspension	ST-5966	ST-5970
		Lower Spring Isolator	ST-6995	
	2008-10		ST-5966	

Suspension Strut Mounts

Model	Years	Location/ Options	Front	Rear	
DODGE PASSENGER CAR (continued)					
CHALLENGER	2008-10	Exc. High Performance Suspension		ST-5969	
		w/ High Performance Suspension		ST-5970	
		Lower Spring Isolator	ST-6995		
	1981-83		ST-2963		
	1978-80		ST-1992		
CHARGER	2011-14	RWD	ST-5968		
		RWD	ST-5966		
		AWD	ST-5967		
					ST-5970
	2007-10	exc. NIVOMAT Rear Suspension	ST-5968		
		RWD	ST-6995	ST-5970	
		w/ NIVOMAT Rear Suspension	ST-5966		
			AWD	ST-5967	ST-5969
	2006	RWD	ST-5966		
		Lower Spring Isolator	ST-6995		
1983-87		ST-1905			
	exc Shelby		ST-1952		
COLT	1993-95		ST-2958	ST-2923	
	1991-92	Hatchback	ST-1977	ST-2923	
	1989-90	Hatchback	ST-1977	ST-2923	
		Wagon	ST-2918		
	1987-88		ST-2918		
	1985-86	L4 1.5L 1468cc:w/o Turbo	ST-2917		
		L4 2.0L 1997cc:w/o Turbo	ST-2917		
	1984		ST-1937		
	1981-83		ST-1937		
	1979-80	Hatchback	ST-1937		
		Sedan & Coupe	ST-1937		
		Wagon	ST-1992		
1977-78	Sedan & Coupe	ST-1937			
	Wagon	ST-1992			
1971-76	Sedan & Coupe	ST-1992			
	Wagon	ST-1992			
CONQUEST	1984-86	exc adj suspension	ST-2961	ST-2962	
DART	2013-16	Upper Spring Isolator	ST-9988		
		Lower Spring Isolator	ST-9989		
DAYTONA	1987-93	exc IROC & IROC RT	ST-1908		
		exc IROC & IROC RT, Upper Spr Seat & Isolator	ST-4916		
		exc IROC & IROC RT, Lower Spring Isolator	ST-3980		
	1986	after 1/86	ST-1908		
		before 1/86	ST-1907		
		after 1/86, Upper Spring Seat & Isolator	ST-4916		
	after 1/86, Lower Spring Isolator	ST-3980			
	1984-85		ST-1907		
DYNASTY	1988-93		ST-1908		
		Upper Spring Seat & Isolator	ST-4916		
		Lower Spring Isolator	ST-3980		
INTREPID	1998-04		ST-3901	ST-3902	
		Upper Spring Isolator	ST-5989	ST-5973	
		Lower Spring Isolator	ST-5988	ST-5982	
	1993-97		ST-1980	ST-1978	
		Upper Spring Seat	ST-3977		
		Lower Spring Isolator	ST-5954	ST-5955	
LANCER	1987-89		ST-1908		
		Upper Spring Seat & Isolator	ST-4916		
		Lower Spring Isolator	ST-3980		
	1986	after 1/86	ST-1908		

Suspension Strut Mounts

Model	Years	Location/ Options	Front	Rear
DODGE PASSENGER CAR (continued)				
LANCER	1986	before 1/86	ST-1907	
		after 1/86, Upper Spring Seat & Isolator	ST-4916	
		after 1/86, Lower Spring Isolator	ST-3980	
	1985		ST-1907	
MAGNUM	2005-08	exc. NIVOMAT Rear Suspension	ST-5968	
		RWD	ST-6995	ST-5970
		w/ NIVOMAT Rear Suspension	ST-5966	
		AWD	ST-5967	ST-5969
MONACO	1990-92	w/ FWD	ST-2929	
NEON	2000-05		ST-3926	ST-3924
		Upper Spring Seat & Isolator	ST-4956	
		Lower Spring Isolator	ST-5992	
	1995-99	Upper Spring Seat & Isolator	ST-2907	ST-2908
		Lower Spring Isolator	ST-3976	ST-4948
OMNI	1978-90	exc GLH 4 Door	ST-1905	ST-1952
SHADOW	1987-94		ST-1908	
		Upper Spring Seat & Isolator	ST-4916	
		Lower Spring Isolator	ST-3980	
SPIRIT	1989-95		ST-1908	
		Upper Spring Seat & Isolator	ST-4916	
		Lower Spring Isolator	ST-3980	
STEALTH	1991-96	w/o Electronic Suspension	ST-2955	ST-2923
STRATUS	2006	Sedan	ST-1940	ST-6917
		Sedan; Bushing Kit		ST-1940
		Upper Spring Isolator; Sedan		ST-7993
		Lower Spring Isolator; Conv. & Sedan		ST-7911
	2001-05	Coupe	ST-4957	ST-2923
		Sedan	ST-1940	ST-6917
		Sedan; Bushing Kit		ST-1940
		Stud Plate Only; Coupe		ST-9947
		Lower Spring Isolator; Coupe	ST-6938	
		Upper Spring Isolator; Convertible & Sedan		ST-7993
		Upper Spring Isolator; Coupe		ST-9969
	Lower Spring Isolator; Conv. & Sedan		ST-7911	
	1995-00		ST-1940	ST-2946
DODGE SPORT UTILITY				
DURANGO	2011-15	exc Auto Leveling System		ST-8999
JOURNEY	2009-15		ST-8984	
		Stud Plate Only		ST-8972
		Upper Spring Isolator	ST-8983	ST-8943
		Lower Spring Isolator	ST-8971	
		Bushing Kit		ST-7995
NITRO	2007-11	Left Side	ST-5903	
		Right Side	ST-5902	
DODGE TRUCK				
DAKOTA	2009-10			
	2005-09	2WD & 4WD	ST-5913	
RAM 1500 PICKUP	2009-10	4WD	ST-7930	
		Upper Spring Seat; 4WD	ST-7931	
	2006-08	4WD	ST-5914	
RAMPAGE	1982-84		ST-1905	

Suspension Strut Mounts

Model	Years	Location/ Options	Front	Rear
DODGE VAN				
CARAVAN	2001-07	Upper Spring Isolator	ST-5911	
		Lower Spring Isolator	ST-5972	
			ST-5971	
	1996-00	Upper Spring Seat	ST-2945	
		Lower Spring Isolator	ST-3975	
			ST-4921	
	1995	after 3/95	ST-2945	
		before 3/95	ST-1908	
		after 3/95, Upper Spring Seat	ST-3975	
		before 3/95, Upper Spring Seat & Isolator	ST-4916	
		after 3/95, Lower Spring Isolator	ST-4921	
	1986-94	before 3/95, Lower Spring Isolator	ST-3980	
			ST-1908	
		Upper Spring Seat	ST-2993	
		Upper Spring Seat & Isolator	ST-4916	
1984-85	Lower Spring Isolator	ST-3980		
		ST-1907		
GRAND CARAVAN	2013-15	exc. NIVOMAT Rear Suspension	ST-6960	
	2008-12	exc. NIVOMAT Rear Suspension	ST-6960	
		Upper Spring Isolator	ST-8982	
	2001-07	Lower Spring Isolator	ST-8971	
			ST-5911	
		Upper Spring Isolator	ST-5972	
	1996-00	Lower Spring Isolator	ST-5971	
		Upper Spring Seat	ST-2945	
		Lower Spring Isolator	ST-3975	
	1995	Upper Spring Isolator	ST-4921	
		after 3/95	ST-2945	
		before 3/95	ST-1908	
		after 3/95, Upper Spring Seat	ST-3975	
		before 3/95, Upper Spring Seat & Isolator	ST-4916	
	1988-94	after 3/95, Lower Spring Isolator	ST-4921	
before 3/95, Lower Spring Isolator		ST-3980		
		ST-1908		
Upper Spring Seat & Isolator		ST-4916		
H100 - VAN (MEXICAN V MINI RAM	1986-88	Lower Spring Isolator	ST-3980	
			ST-1908	
1984-85		ST-6968		
EAGLE PASSENGER CAR				
2000 GTX	1991-93	exc Auto leveling system		ST-2923
MEDALLION	1988-89		ST-2929	
PREMIER	1988-92		ST-2929	
SUMMIT	1993-96		ST-2958	ST-2923
	1989-92		ST-1977	ST-2923
TALON	1995-98		ST-2923	
		Stud Plate Only		ST-9947
		Upper Spring Isolator		ST-7993
1990-94		Bushing Kit		ST-2923
			ST-2920	ST-2923
VISION	1993-97		ST-1980	ST-1978
		Upper Spring Seat	ST-3977	
		Lower Spring Isolator	ST-5954	ST-5955
VISTA	1989-92	exc Wagon	ST-2918	

Suspension Strut Mounts

Model	Years	Location/ Options	Front	Rear
FORD PASSENGER CAR				
ASPIRE	1994-97	exc ABS Brakes	ST-2940	ST-2970
CONTOUR	1995-00		ST-2953	ST-2954
CROWN VICTORIA	2003-11	exc. Police Cars	ST-7944	
		Upper Spring Seat; Exc. Police Car	ST-7945	
C-MAX	2013-18		ST-8961	
ESCORT	1997-03	exc ABS Brakes	ST-4913	ST-1963
		exc ABS Brakes, Upper Spring Seat & Isolator	ST-4936	
		exc ABS Brakes, Lower Spring Isolator	ST-4922	
	1991-96		ST-2936	ST-1963
		Upper Spring Seat & Isolator	ST-3965	
		Lower Spring Isolator		ST-4922
	1986-90		ST-1927	ST-1956
		Bearing Only	ST-1901	
	1985	after 3/85	ST-1927	
		before 3/85	ST-1916	
Bearing Only		ST-1901	ST-1956	
1981-84		ST-1916	ST-1956	
EXP	1986-88		ST-1927	ST-1956
		Bearing Only	ST-1901	
	1985	after 3/85	ST-1927	
		before 3/85	ST-1916	
1982-84		ST-1916	ST-1956	
FAIRMONT	1978-83		ST-1925	
FESTIVA	1988-93		ST-2940	ST-2970
FIESTA	2011-18		ST-7996	ST-7997
	2003-10		ST-98001	
	1998-01		ST-98000	
FIESTA IKON (MEXICO)	2002-04		ST-98000	
FIGO (MEXICO)	2016-18		ST-7996	
FIVE HUNDRED	2005-07	FWD		ST-7901
		Upper Spring Isolator, exc AWD		ST-6996
		Upper Spring Isolator; AWD		ST-6997
			ST-5915	
		AWD	ST-7948	ST-7900
	Upper Spring Isolator; AWD		ST-7998	
FOCUS	2017-18	REAR		
	2012-16		ST-8961	
	2008-11		ST-8968	
		Sedan & Hatchback, exc SVT		ST-4927
	2006-07	exc SVT	ST-3928	
		Sedan & Hatchback, exc SVT		ST-4927
	2000-05	Sedan & Hatchback, exc SVT	ST-3928	ST-4927
		Station Wagon	ST-3928	
	Upper Spring Seat	ST-6932		
FREESTYLE	2005-07	FWD		ST-7901
		Upper Spring Isolator		ST-6998
		Upper Spring Isolator; AWD		ST-6999
			ST-5915	
		AWD	ST-7948	ST-7900
	Upper Spring Isolator; AWD		ST-7998	
FUSION	2006-12		ST-5918	
		Upper Spring Seat & Bearing	ST-6961	
		Lower Spring Isolator	ST-9929	
GRAND MARQUIS (MEXI)	2003-04		ST-7944	
		Upper Spring Seat & Isolator	ST-7945	
GRANADA	1981-82		ST-1925	

Suspension Strut Mounts

Model	Years	Location/ Options	Front	Rear
FORD PASSENGER CAR (continued)				
IKON (MEXICAN VEHICL	2003-07		ST-98000	
KA (MEXICAN VEHICLE)	2001-07		ST-98000	
LTD	1983-86		ST-1925	
MUSTANG	2011-14		ST-9906	
	2005-10		ST-5915	
		Upper Spring Isolator	ST-7948	
	1985-04		ST-1925	
MUSTANG II	1985-04		ST-1925	
POLICE INTERCEPTOR	2013-19		ST-9916	
PROBE	1993-97	Left Side	ST-2922	ST-2952
		Right Side	ST-2922	ST-2951
		Upper Spring Seat	ST-3964	
	1989-92	w/ Auto Trans	ST-1999	ST-1960
		w/ Manual Trans exc Programmed Ride Control w/ Man Trans, exc PRC, Upper Spring Seat	ST-2935 ST-3905	ST-1960
SPECIAL SERVICE POLI	2014-18		ST-9916	
TAURUS	2013-19		ST-9916	
	2012		ST-9915	
	2010-11		ST-6962	
		Upper Spring Isolator	ST-9914	
		Lower Spring Isolator	ST-7999	
	2009		ST-6962	
		Left Side; AWD		ST-7900
		Left Side; w/ FWD		ST-6998
		Right Side; AWD		ST-7901
		Right Side; w/ FWD		ST-6999
		Upper Spring Isolator	ST-9914	
		Lower Spring Isolator	ST-7999	
		Upper Spring Isolator; AWD		ST-7998
	2008		ST-6962	
		Left Side; AWD		ST-7900
		Left Side; w/ FWD		ST-6998
		Right Side; AWD		ST-7901
		Right Side; w/ FWD		ST-6999
		Upper Spring Isolator; From 8/13/08	ST-9914	
		Lower Spring Isolator	ST-7999	
		Upper Spring Isolator; AWD		ST-7998
	1996-07	exc SHO	ST-2944	
		exc SHO & Station Wagon		ST-1954
exc SHO, Upper Spring Seat		ST-3968		
exc SHO, Lower Spring Isolator		ST-4937	ST-5964	
1986-95		ST-1926		
	exc Station Wagon		ST-1954	
	Bearing Only	ST-1902		
	Upper Spring Seat	ST-3967		
	Lower Spring Isolator	ST-5965		
TAURUS X	2008-09		ST-6962	
		Left Side; AWD		ST-7900
		Left Side; w/ FWD		ST-6998
		Right Side; AWD		ST-7901
		Right Side; w/ FWD		ST-6999
		Upper Spring Isolator	ST-9914	
		Lower Spring Isolator	ST-7999	
	Upper Spring Isolator; AWD		ST-7998	
TEMPO	1984-94		ST-1927	ST-1955
		Bearing Only	ST-1901	
		Upper Spring Isolator		ST-3966
THUNDERBIRD	2002-05		ST-4972	ST-4972

Suspension Strut Mounts

Model	Years	Location/ Options	Front	Rear
FORD PASSENGER CAR (continued)				
THUNDERBIRD	1989-97	exc Super Coupe	ST-1970	
		exc Super Coupe, Lower Spring Isolator	ST-4920	
	1987-88	exc Turbo Coupe	ST-1974	
	1980-86		ST-1971	
FORD SPORT UTILITY				
ECOSPORT (MEXICO)	2013-16		ST-7996	
	2004-12		ST-98001	
EDGE	2011-15		ST-9906	
	2007-10		ST-6962	
		Upper Spring Isolator	ST-7948	
ESCAPE	2013-18		ST-8961	
	2001-12		ST-4938	
		Upper Spring Isolator	ST-7906	
		Upper Spring Seat	ST-7905	
Lower Spring Isolator		ST-7907		
EXPEDITION	2007-18	Exc. Air Suspension	ST-6963	ST-7934
		Upper Spring Isolator; Exc. Air Suspension		ST-7936
		Upper Spring Seat; Exc. Air Suspension		ST-7935
	2003-06	Exc. Air Suspension	ST-4974	ST-4973
EXPLORER	2014-19		ST-9916	
	2013	From 9/3/12	ST-9916	
		To 9/3/12	ST-9905	
	2011-12		ST-9905	
	2006-10		ST-7937	ST-7940
		Upper Spring Isolator	ST-7939	
		Upper Spring Isolator	ST-7938	ST-7941
	2002-05	Stud Plate Only	ST-6918	ST-6927
Upper Spring Isolator		ST-6923	ST-6925	
Upper Spring Seat		ST-6924	ST-6926	
		ST-7937	ST-7940	
EXPLORER SPORT TRA	2007-10		ST-7939	ST-7941
		Upper Spring Isolator	ST-7939	ST-7941
FLEX	2013-19		ST-9916	
	2012		ST-9915	
	2009		ST-6962	
		Upper Spring Isolator	ST-9914	
FORD TRUCK				
F-150 PICKUP	2009-18		ST-6963	
	2004-08	2WD & 4WD, exc Heritage	ST-4970	
LOBO (MEXICAN VEHIC	2009-14		ST-6963	
FORD VAN				
FREESTAR	2004-07		ST-4971	
		Upper Spring Seat	ST-6994	
TRANSIT CONNECT	2014-19		ST-8961	
	2010-13		ST-8900	
WINDSTAR	1995-03		ST-2910	
		Lower Spring Isolator	ST-4949	
GEO PASSENGER CAR				
METRO	1989-97	exc ABS Brakes	ST-1987	ST-1988
PRIZM	1989-97		ST-5912	ST-2901
SPECTRUM	1989		ST-1932	
STORM	1990-93		ST-2932	ST-2959

Suspension Strut Mounts

Model	Years	Location/ Options	Front	Rear
GEO SPORT UTILITY				
TRACKER	1989-97	exc ABS Brakes	ST-1994	
GMC SPORT UTILITY				
ACADIA	2007-16	Upper Spring Isolator	ST-7986	
		Lower Spring Isolator	ST-9923	
			ST-9924	
ENVOY	2002-08	2WD & 4WD	ST-4968	
ENVOY XL / XUV	2002-06	2WD & 4WD	ST-4968	
JIMMY	1988-99	Torsion Bar Mount; 4WD	ST-2992	
S15 JIMMY	1988-94	Torsion Bar Mount; w/ 4WD	ST-2992	
TERRAIN	2010-16	Exc. 19" Wheels	ST-6956	
TRACKER	1989-91		ST-1994	
YUKON	2007-14	4 Door, 2WD & 4WD, exc Z55 & ZW7 Suspensions	ST-5910	
		Upper Spring Isolator	ST-7942	
YUKON XL 1500	2007-14	4 Door, 2WD & 4WD, exc Z55 & ZW7 Suspensions	ST-5910	
		Upper Spring Isolator	ST-7942	
GMC TRUCK				
CANYON	2004-12	RWD	ST-9921	
SIERRA 1500	2007-14	2WD & 4WD, exc Z55 and ZW7 Suspension	ST-5910	
		Upper Spring Isolator	ST-7942	
SONOMA	1991-99	Torsion Bar Mount; 4WD	ST-2992	
HONDA PASSENGER CAR				
ACCORD	2013-14			ST-9912
	2008-12	Stud Plate; Left Side	ST-9917	
		Stud Plate; Right Side	ST-9918	
		Upper Spring Isolator	ST-9922	
	2003-07	Stud Plate Only	ST-7976	
		Upper Spring Isolator	ST-7977	
		Lower Spring Isolator	ST-6950	ST-6951
		Bushing Kit	ST-1940	ST-1961
	1998-02	Bushing	ST-1940	ST-1961
		Stud Plate Only	ST-5986	ST-5987
		Upper Spring Isolator	ST-5993	ST-5994
		Lower Spring Isolator		ST-6949
	1994-97	Stud Plate Only	ST-5901	ST-4993
		Upper Spring Isolator		ST-5974
		Lower Spring Isolator		ST-5975
		Bushing Kit	ST-1940	ST-1961
	1990-93	Stud Plate Only	ST-5901	ST-4993
		Bushing Kit		ST-1961
		Upper Spring Isolator	ST-5920	
		Lower Bushing		ST-6915
1986-89		ST-1940	ST-1961	
	Lower Bushing		ST-6915	
1982-85		ST-1933	ST-1961	
1979-81			ST-1961	
CIVIC	2012-15	Sedan	ST-7957	
	2006-11	Sedan	ST-9945	
			ST-6964	
		Coupe	ST-7957	
	2002-05	Sedan & Coupe, Left Side	ST-4997	
		Si Hatchback, Left Side	ST-6920	
		Sedan & Coupe, Right Side	ST-4996	
		Si Hatchback, Right Side	ST-6919	
	Bushing Kit		ST-1940	

Suspension Strut Mounts

Model	Years	Location/ Options	Front	Rear	
HONDA PASSENGER CAR (continued)					
CIVIC	2002-05	Stud Plate Only		ST-7915	
		Upper Spring Isolator	ST-7917	ST-7914	
		Upper Spring Seat	ST-7916		
	2001	Left Side	ST-6920		
		Right Side	ST-6919		
		Bushing Kit		ST-1940	
		Stud Plate Only		ST-7915	
		Upper Spring Seat	ST-7916		
		Upper Spring Isolator		ST-7914	
	1996-00			ST-1940	ST-1940
		Upper Spring Isolator	ST-5976	ST-5977	
	1992-95	Stud Plate Only	ST-5919	ST-5956	
		Upper Spring Isolator	ST-5976	ST-5977	
		Lower Bushing		ST-6916	
		Bushing Kit	ST-1940	ST-1940	
1989-91		ST-1940	ST-1940		
	Lower Bushing		ST-6916		
1988	exc Wagon	ST-1940			
	Lower Bushing		ST-1940		
1984-87	FWD	ST-1939	ST-1961		
	Lower Bushing		ST-6915		
1980-83			ST-1961		
CIVIC DEL SOL	1993-97		ST-1940	ST-1940	
		Lower Bushing		ST-6916	
CRX	1989-91		ST-1940	ST-1940	
		Lower Bushing		ST-6916	
	1988	Lower Bushing	ST-1940	ST-1940	
CROSSTOUR	2012-15	Stud Plate; Left Side	ST-9917		
		Stud Plate; Right Side	ST-9918		
		Upper Spring Isolator	ST-9922		
CR-Z	2011-12		ST-6965		
FIT	2007-12		ST-6965		
INSIGHT	2010-12		ST-6965		
PRELUDE	1992-01		ST-1940	ST-1961	
		Upper Spring Seat		ST-3982	
	1988-91		ST-1940	ST-2950	
	1983-87		ST-1940	ST-1961	
S2000	2002-08		ST-1940	ST-1940	
HONDA SPORT UTILITY					
CR-V	2012-14		ST-6966	ST-1940	
	2007-11		ST-6966		
		Stud Plate Only		ST-9946	
		Upper Spring Isolator		ST-7914	
		Upper Spring Seat		ST-9959	
		Bushing Kit		ST-1940	
	2002-06	Left Side	ST-6920		
		Right Side	ST-6919		
Upper Spring Isolator			ST-1940		
1997-01		ST-1940	ST-1940		
ELEMENT	2007-11	Bushing Kit	ST-9927		
		Right Side	ST-6920	ST-9920	
		Stud Plate Only	ST-6919		
			ST-9930	ST-1940	
	2003-06	Bushing Kit	ST-9927		

Suspension Strut Mounts

Model	Years	Location/ Options	Front	Rear	
HONDA SPORT UTILITY (continued)					
ELEMENT	2003-06	Right Side	ST-6920	ST-9920	
		Stud Plate Only	ST-6919		
			ST-9930	ST-1940	
PILOT	2009-15		ST-5904		
	2003-08		ST-4975		
HONDA TRUCK					
RIDGELINE	2006-14		ST-7983		
HONDA VAN					
WAGOVAN	1986-87	Lower Bushing		ST-6915	
	1984	Lower Bushing		ST-6915	
ODYSSEY	2013-17		ST-5904		
	2008-10		ST-5904		
	2005-07		Upper Spring Isolator	ST-9978	
			Upper Spring Seat	ST-9977	
				ST-4975	
	1999-04		Upper Spring Isolator	ST-7919	
			Lower Spring Isolator	ST-7920	
1995-98		ST-1940	ST-1940		
HYUNDAI PASSENGER CAR					
ACCENT	2006-11	Left Side	ST-6970		
		Right Side	ST-6969		
				ST-6971	
			Upper Spring Isolator	ST-9938	
			Upper Spring Seat	ST-9937	
	2000-05		Lower Spring Isolator	ST-7950	
				ST-3938	ST-6936
			Bushing		ST-3939
			Stud Plate Only		ST-8939
	1997-99		Upper Spring Isolator	ST-8930	
			Upper Spring Seat	ST-8929	
1995-96			ST-2915	ST-6936	
		Bushing		ST-3939	
		Stud Plate Only		ST-8939	
AZERA	2012-17		ST-8997		
	2006-11		ST-5983	ST-5984	
ELANTRA	2007-12		ST-6967		
			Upper Spring Isolator	ST-9949	
			Upper Spring Seat	ST-9948	
	2001-06		Lower Spring Isolator	ST-7953	
			Left Side	ST-2984	ST-3935
			Right Side	ST-2984	ST-3936
			Upper Spring Isolator	ST-8932	ST-8950
			Upper Spring Seat	ST-8931	
	1996-00		Lower Spring Isolator		ST-6948
			Left Side	ST-2984	ST-3935
			Right Side	ST-2984	ST-3936
		Lower Spring Isolator	ST-6943	ST-6939	
1992-95		Upper Spring Isolator		ST-8950	
		exc ABS Brakes	ST-1977	ST-2923	
EXCEL	1990-94		ST-1938		
	1986-89	exc sealed strut	ST-1937		
SCOUPE	1991-95		ST-1938		
SONATA	2011-19		ST-8997		
	2006-10		ST-5983	ST-5984	

Suspension Strut Mounts

Model	Years	Location/ Options	Front	Rear
HYUNDAI PASSENGER CAR (continued)				
SONATA	2001-05	Stud Plate Only	ST-8976	
		Upper Spring Isolator	ST-8978	
		Bushing Kit	ST-2923	ST-2923
	2000	Stud Plate Only	ST-8976	ST-3937
		Upper Spring Isolator	ST-8978	
		Bushing Kit	ST-2923	ST-2923
	1999		ST-2923	ST-3937
	1995-98		ST-2914	ST-2964
	1989-94		ST-1976	ST-2964
TIBURON	2003-08	Left Side		ST-3935
		Right Side		ST-3936
	1997-01	Left Side	ST-2984	ST-3935
		Right Side	ST-2984	ST-3936
		Upper Spring Seat	ST-8931	
		Lower Spring Isolator	ST-6943	ST-6939
XG300	2001		ST-2923	ST-2923
XG350	2002-05		ST-2923	ST-2923
HYUNDAI SPORT UTILITY				
SANTA FE	2007-09	Lower Spring Isolator	ST-6968	
			ST-7952	
	2001-06	Upper Spring Isolator	ST-4957	
		Upper Spring Seat	ST-8980	
		Lower Spring Isolator	ST-8979	
		ST-8981		
TUCSON	2005-10		ST-4957	
		Left Side		ST-3935
		Right Side		ST-3936
		Upper Spring Isolator	ST-8938	
		Upper Spring Seat	ST-8937	
VERACRUZ	2007-12		ST-6968	
HYUNDAI VAN				
ENTOURAGE	2007-09		ST-6968	
INFINITI PASSENGER CAR				
G20	1999-02		ST-3911	ST-3911
	1991-96		ST-3911	
I30	2000-01	Stud Plate Only	ST-6914	ST-4979
		Upper Spring Isolator	ST-8956	
		Upper Spring Seat	ST-8957	
		1996-99		ST-8955
I35	2002-04		ST-3910	ST-3911
			ST-6914	ST-4979
		Stud Plate Only	ST-8956	
		Upper Spring Isolator	ST-8957	
		Upper Spring Seat	ST-8955	
M30	1990-92	w/ Sonar Suspension - bearing Only; Coupe	ST-1947	
Q45	1997-05	exc Active Suspension	ST-3958	ST-3911
	1994-96	exc Active Suspension	ST-3910	ST-3911
	1993	after 1/93, exc Active Suspension	ST-3910	
		exc Active Suspension		ST-3911
	1990-92	exc Active Suspension		ST-3911

Suspension Strut Mounts

Model	Years	Location/ Options	Front	Rear
INFINITI SPORT UTILITY				
FX35	2003-08		ST-6914	
FX45	2003-08		ST-6914	
QX4	2002-03		ST-3954	
	1999-01	Mount & Bearing	ST-3954	
		Stud Plate Only	ST-7978	
		Upper Spring Isolator	ST-7980	
		Upper Spring Seat	ST-7979	
	1997-98		ST-3954	
ISUZU PASSENGER CAR				
I-MARK	1985-89		ST-1932	
IMPULSE	1990-92	exc ABS Brakes	ST-2932	ST-2959
STYLUS	1991-93		ST-2932	ST-2959
ISUZU SPORT UTILITY				
ASCENDER	2003-08	w/ Rear Coil Spring Suspension	ST-4968	
		w/ Rear Air Spring Susp, Lower Spring Seat	ST-4962	
ISUZU VAN				
OASIS	1996-99		ST-1940	ST-1940
JAGUAR				
S-TYPE	2000-05	exc Computer Active Tech. Suspension	ST-4972	ST-4972
X-TYPE	2002-08	w/o Electronic Suspension	ST-8967	
JEEP SPORT UTILITY				
COMMANDER	2006-10		ST-5922	
		Lower Spring Isolator	ST-8949	
COMPASS	2007-16		ST-7994	
		Stud Plate Only		ST-8972
		Upper Spring Isolator		ST-8943
		Bushing Kit		ST-6959
GRAND CHEROKEE	2011-13	Stud Plate Only		ST-8999
	2005-10		ST-5922	
LIBERTY	2002-12	Lower Spring Isolator	ST-8949	
		Left Side	ST-5903	
PATRIOT	2007-16	Right Side	ST-5902	
			ST-7994	
PATRIOT	2007-16	Stud Plate Only		ST-8972
		Upper Spring Isolator		ST-8943
		Bushing Kit		ST-6959
KIA PASSENGER CAR				
AMANTI	2007-09		ST-5983	ST-5984
	2004-06		ST-5923	ST-5923
CADENZA	2014-16		ST-8997	
MAGENTIS	2001-06		ST-2923	ST-5990
OPTIMA	2011-17		ST-8997	
	2007-10	Left Side	ST-6973	
		Right Side	ST-6974	
		Upper Spring Isolator	ST-9999	
		Upper Spring Seat	ST-9998	
		Lower Spring Isolator	ST-7953	
		2006	New Body Style: Left Side	ST-6973
	New Body Style: Right Side		ST-6974	
	New Body Style: Upper Spring Isolator		ST-9999	
			Upper Spring Seat	ST-9998
		Lower Spring Isolator	ST-7953	
	2001-05		ST-2923	ST-5990
RIO	2006-11	Lower Spring Isolator	ST-6975	

Suspension Strut Mounts

Model	Years	Location/ Options	Front	Rear	
KIA PASSENGER CAR (continued)					
RIO	2006-11	Upper Spring Isolator	ST-7950		
		Upper Spring Seat	ST-9938		
			ST-6976	ST-6971	
			Upper Spring Seat	ST-9937	
	2003-05	Left Side	ST-5926		
		Right Side	ST-5925		
	2001-02	To 7/1/02	ST-5925		
To 7/1/02		ST-4980			
From 7/1/02		ST-5926			
RIO5	2006-11	Lower Spring Isolator	ST-6975		
			ST-6976	ST-6971	
		Lower Spring Isolator	ST-7950		
RONDO	2007-11	Upper Spring Seat	ST-7953		
		Upper Spring Seat	ST-6974		
			ST-6973	ST-5984	
		Upper Spring Seat	ST-9998		
SEPHIA	2001	Left Side		ST-3940	
		Right Side		ST-3941	
	2000	before 6/00	ST-2922	ST-3940	
		before 6/00		ST-3941	
	1998-99		ST-2922		
		Left Side		ST-3940	
		Right Side		ST-3941	
	1995-97	Left Side	ST-3942	ST-3940	
Right Side		ST-3942	ST-3941		
SPECTRA	2005-09		ST-2984		
		Left Side		ST-3935	
		Right Side		ST-3936	
		Upper Spring Seat	ST-8931		
		Lower Spring Isolator	ST-7951		
	2004	Lower Spring Isolator		ST-8904	
		Lower Spring Isolator		ST-8905	
		EX & LX	ST-2984	ST-3935	
		Exc. EX & LX	ST-8903	ST-3936	
		Lower Spring Isolator		ST-7951	
	2002-03		ST-8903	ST-8904	
				ST-8905	
	2001	From 6/01	ST-2922	ST-8905	
			ST-8903	ST-8904	
2000		ST-2922			
SPECTRA5	2005-09		ST-2984		
		Left Side		ST-3935	
		Right Side		ST-3936	
		Lower Spring Isolator		ST-7951	
KIA SPORT UTILITY					
SORENTO	2003-06		ST-5927		
SPORTAGE	2005-10	Left Side		ST-3935	
		Right Side		ST-3936	
		Upper Spring Isolator	ST-8938		
	Upper Spring Seat	ST-8937			
	1995-02		ST-4981		

Suspension Strut Mounts

Model	Years	Location/ Options	Front	Rear
KIA VAN				
SEDONA	2006-11		ST-6968	
	2002-05		ST-6977	
		Lower Spring Isolator	ST-7954	
LAND ROVER SPORT UTILITY				
FREELANDER	2002-05			ST-5929
LEXUS PASSENGER CAR				
CT200H	2011-17		ST-6988	
ES250	1990-91		ST-1944	ST-1962
			ST-6936	
ES300	1997-03	exc Adaptive Variable Suspension, Left Side	ST-3906	ST-3904
		exc Adaptive Variable Suspension, Right Side	ST-3903	ST-3904
		Upper Spring Seat & Isolator	ST-4950	
		Lower Spring Isolator	ST-4951	ST-4953
			ST-3991	
	1995-96	Upper Spring Seat & Isolator	ST-4950	
		Lower Spring Isolator	ST-4951	ST-4953
		Upper Spring Isolator		ST-4952
	1992-94	Lower Spring Isolator	ST-5997	ST-4952
		Upper Spring Isolator	ST-6937	
		ST-2926	ST-4953	
ES300H	2013-15	Upper Spring Seat	ST-9942	
ES330	2004-06	exc Adaptive Variable Suspension	ST-4989	ST-3904
		Lower Spring Isolator	ST-6935	ST-6935
ES350	2013-15	Upper Spring Seat	ST-9942	
	2010-12	Lower Spring Isolator		ST-8965
			ST-6986	ST-8966
	2007-09	Lower Spring Isolator	ST-6986	ST-8966
		ST-6935	ST-8965	
GS300	1998-05		ST-3997	ST-5930
	1993-97		ST-3997	ST-5931
		Lower Spring Isolator		ST-7961
GS400	1998-00		ST-3997	ST-5930
GS430	2001-05		ST-3997	ST-5930
HS250H	2010-12	Upper Spring Isolator	ST-9931	
IS300	2001-05		ST-5932	ST-5930
LS400	1995-00	exc Auto Leveling System	ST-5933	ST-3999
	1990-94	exc Auto Leveling System	ST-3998	ST-4918
LS430	2001-06		ST-5934	ST-5935
SC300	1992-00		ST-5938	ST-4902
SC400	1992-00		ST-5938	ST-4902
SC430	2002-08		ST-3997	ST-5940
LEXUS SPORT UTILITY				
RX300	1999-03	Left Side	ST-3906	ST-3904
		Right Side	ST-3903	ST-3904
RX330	2004-06	Left Side, exc Air Suspension	ST-4989	ST-5937
		Right Side, exc Air Suspension	ST-4989	ST-5936
		Upper Spring Isolator; Exc. Air Suspension	ST-9943	
		Upper Spring Seat; Exc. Air Suspension	ST-9942	
			ST-9943	
RX350	2007-14	Upper Spring Isolator; Exc. Air Suspension	ST-9943	
		Upper Spring Seat; Exc. Air Suspension	ST-9942	
RX400H	2006-08	Upper Spring Isolator	ST-9943	
		Upper Spring Seat	ST-9942	
RX450H	2010-15	Upper Spring Isolator; Exc. Air Suspension	ST-9943	
		Upper Spring Seat; Exc. Air Suspension	ST-9942	

Suspension Strut Mounts

Model	Years	Location/ Options	Front	Rear
LINCOLN PASSENGER CAR				
CONTINENTAL	1997-02		ST-4911	
	1988-94	Repl. strut Mount for Coil Spring Conversion Kit	ST-1926	ST-2997
	1982-87		ST-1971	
LS	2000-06		ST-4972	ST-4972
MARK VII	1984-92		ST-1971	
MKS	2013-16		ST-9916	
	2012		ST-9915	
	2010-11	Upper Spring Isolator Lower Spring Isolator	ST-9914 ST-7999	
MKZ	2007-12		ST-5918	
		Upper Spring Seat & Isolator	ST-6961	
		Lower Spring Isolator	ST-9929	
TOWN CAR	2003-11		ST-7944	
		Upper Spring Isolator	ST-7945	
ZEPHYR	2006		ST-5918	
		Upper Spring Seat & Isolator	ST-6961	
LINCOLN SPORT UTILITY				
MKC	2015-19		ST-8961	
MKT	2016-19	w/o Electronic Suspension	ST-9916	
	2013-15		ST-9916	
	2012		ST-9915	
	2010-11	Upper Spring Isolator Lower Spring Isolator	ST-9914 ST-7999	
MKX	2011-15		ST-9906	
	2007-10	Upper Spring Isolator	ST-6962 ST-7948	
LINCOLN TRUCK				
MARK LT	2006-08		ST-4970	
MAZDA PASSENGER CAR				
2	2011-16		ST-7996	ST-7997
3	2004-12		ST-6980	ST-6981
6	2009-13	Stud Plate Only	ST-8994	
		Upper Spring Seat & Bearing	ST-6961	
	2005-08		ST-5918	
		Upper Spring Seat & Isolator Lower Spring Isolator	ST-6961 ST-9929	
	2003-04	Upper Spring Isolator	ST-5917 ST-9903	
323	1990-94		ST-2936	ST-1963
	1986-89	Sedan & Hatchback, 2WD	ST-1930	ST-1959
		Sedan & Hatchback, AWD Wagon	ST-1930 ST-1930	
626	2000-02	Left Side	ST-4954	ST-4999
		Right Side	ST-4954	ST-4998
		Upper Spring Seat	ST-3964	
	1998-99	Left Side	ST-4954	ST-2952
		Right Side	ST-4954	ST-2951
		Upper Spring Seat	ST-3964	
	1993-97	Left Side	ST-2922	ST-2952
		Right Side	ST-2922	ST-2951
		Upper Spring Seat	ST-3964	
	1988-92	Auto Trans; exc. Turbo 4WS Model	ST-1999	ST-1960
		Manual Trans.; exc. Turbo 4WS Model	ST-2935	ST-1960
Upper Spring Seat		ST-3905		
1986-87	w/ Manual TRANS, exc Auto Adj Suspension	ST-2939		
1983-85	Left Side, exc Auto Adj Suspension	ST-2939	ST-2943	

Suspension Strut Mounts

Model	Years	Location/ Options	Front	Rear
MAZDA PASSENGER CAR (continued)				
626	1983-85	Right Side, exc Auto Adj Suspension	ST-2939	ST-2942
	1979-82	after chassis # CB2MS-543879; Sedan & Coupe	ST-2934	
929	1990-91		ST-3943	
		exc Auto adj suspension		ST-2966
	1988-89	exc Auto adj suspension	ST-2960	ST-2966
GLC	1981-85	exc Wagon	ST-1930	ST-1959
MIATA - MX5	2006-12		ST-6982	ST-6982
	1999-05		ST-2970	ST-2970
	1990-97		ST-2919	ST-2919
MILLENNIA	1997-00			ST-8908
	1995			ST-8909
MX-3	1992-95	Coupe	ST-2936	ST-1963
MX-6	1993-97	Left Side	ST-2922	ST-2952
		Right Side	ST-2922	ST-2951
		Upper Spring Seat	ST-3964	
	1988-92	Auto Trans; exc. GT 4WS Model	ST-1999	ST-1960
		Manual Trans; exc. GT 4WS Model	ST-2935	ST-1960
		Upper Spring Seat	ST-3905	
PROTEGE	1999-03		ST-4983	
		Left Side		ST-4995
		Right Side		ST-4994
		Upper Spring Isolator	ST-8934	
		Upper Spring Seat	ST-8933	
		Lower Spring Isolator	ST-6942	
	1995-98	Left Side	ST-3907	ST-3909
		Right Side	ST-3907	ST-3908
		Lower Spring Isolator	ST-6940	
	1992-94	FWD	ST-2936	ST-1963
1990-91	AWD	ST-2936		
	FWD	ST-2936	ST-1963	
PROTEGE5	2002-03		ST-4983	
		Left Side		ST-4995
		Right Side		ST-4994
		Lower Spring Isolator	ST-6942	
RX-7	1986-91	exc Auto adj suspension	ST-2974	ST-2975
	1981-85	exc GSL-SE	ST-2934	
	1980	after NOV 1, exc GSL-SE	ST-2934	
RX-8	2004-11		ST-6982	ST-6982
MAZDA SPORT UTILITY				
CX-7	2007-12		ST-8907	
CX-9	2007-14		ST-8907	
TRIBUTE	2008-11	2WD & 4WD	ST-4938	
		Upper Spring Isolator	ST-7906	
		Upper Spring Seat	ST-7905	
		Lower Spring Isolator	ST-7907	
	2006	AWD	ST-4938	
		Upper Spring Isolator	ST-7906	
		Upper Spring Seat	ST-7905	
		Lower Spring Isolator	ST-7907	
	2001-05	2WD & 4WD	ST-4938	
		Upper Spring Isolator	ST-7906	
Upper Spring Seat		ST-7905		
Lower Spring Isolator		ST-7907		

Suspension Strut Mounts

Model	Years	Location/ Options	Front	Rear
MAZDA VAN				
5	2012-14		ST-6980	ST-6981
	2006-10		ST-6980	ST-6981
MPV	2000-06	FWD	ST-4958	
	1989-98	exc Auto leveling system	ST-2921	
MERCEDES-BENZ PASSENGER CAR				
190D	1984-89		ST-2902	
190E	1984-93		ST-2902	
260E	1987-89	exc 4 MATIC	ST-2902	
300CE	1988-93		ST-2902	
300D	1990-93	exc 4 MATIC	ST-2902	
	1987	exc 4 MATIC	ST-2902	
300E	1986-93		ST-2902	
300TE	1988-93	exc 4 MATIC	ST-2902	
400E	1992-93		ST-2902	
B200	2006-11		ST-10005	
C240	2003-05	RWD	ST-6934	
	2001-02		ST-6934	
C250	2012-15		ST-10007	
		Bearing Only	ST-10010	
C300	2008-14		ST-10007	
		Bearing Only	ST-10010	
C320	2003-05	RWD	ST-6934	
	2001-02		ST-6934	
C350	2008-15		ST-10007	
		Bearing Only	ST-10010	
C63 AMG S	2015		ST-10007	
		Bearing Only	ST-10010	
C63 AMG	2008-15		ST-10007	
		Bearing Only	ST-10010	
CLA250	2013-18	Bearing Only	ST-10010	
CLA45 AMG	2014-18	Bearing Only	ST-10010	
CLS400	2015	Exc. Air Suspension	ST-10006	
		Bearing Only; exc. 4-Matic; exc. Airmatic Suspension	ST-10010	
CLS500	2005-06	exc. Airmatic Suspension	ST-10002	
CLS550	2013-15	exc. Airmatic Suspension	ST-10006	
		Bearing Only; Exc. AWD; exc. Air Suspension	ST-10010	
CLS55 AMG	2006	V8 5.5L 5439cc;Exc. Air Suspension	ST-10002	
CLS63 AMG S	2014-15	exc. Airmatic Suspension	ST-10006	
		Bearing Only; exc. 4-Matic; exc. Airmatic Suspension	ST-10010	
CLS63 AMG	2013-14	exc. Airmatic Suspension	ST-10006	
		Bearing Only; exc. 4-Matic; exc. Airmatic Suspension	ST-10010	
E250	2014-15	exc. Airmatic Suspension	ST-10006	
		Bearing Only; exc. 4-Matic; exc. Airmatic Suspension	ST-10010	
E300D	1995	exc Rear Axle Level Control	ST-2902	
E320	2003-09	exc. Airmatic Suspension; exc. 4-Matic	ST-10002	
	1994-96		ST-2902	
E350	2010-15	Airmatic Suspension; w/o VDS	ST-10007	
		Coil Spring Suspension	ST-10006	
		Bearing Only; exc. 4-Matic; exc. Airmatic Suspension	ST-10010	
	2006-09	exc. Airmatic Suspension; exc. 4-Matic	ST-10002	
E400	2013-15	Airmatic Suspension; w/o VDS	ST-10007	
		Coil Spring Suspension	ST-10006	

Suspension Strut Mounts

Model	Years	Location/ Options	Front	Rear
MERCEDES-BENZ PASSENGER CAR (continued)				
E400	2013-15	Bearing Only; exc. 4-Matic; exc. Airmatic Suspension	ST-10010	
E420	1994-95		ST-2902	
E500	2003-06	exc. Airmatic Suspension	ST-10002	
	1994		ST-2902	
E550	2010-15	Airmatic Suspension; w/o VDS	ST-10007	
		Coil Spring Suspension	ST-10006	
		Bearing Only; exc. 4-Matic; exc. Airmatic Suspension	ST-10010	
	2007-09	exc. Airmatic Suspension	ST-10002	
E55 AMG	2003-06	exc. Airmatic Suspension	ST-10002	
E63 AMG	2010-15	exc. Airmatic Suspension	ST-10006	
		Bearing Only; exc. 4-Matic; exc. Airmatic Suspension	ST-10010	
	2007-09	exc. Airmatic Suspension	ST-10002	
E63 AMG S	2014-15	exc. Airmatic Suspension	ST-10006	
		Bearing Only; exc. 4-Matic; exc. Airmatic Suspension	ST-10010	
SL320	1994-97		ST-3944	
SL500	1994-02		ST-3944	
SL600	1994-02		ST-3944	
SLK250	2012-15	Bearing Only; exc. 4-Matic; exc. Airmatic Suspension	ST-10010	
SLK350	2012-15	Bearing Only; exc. 4-Matic; exc. Airmatic Suspension	ST-10010	
SLK55 AMG	2012-15	Bearing Only; exc. 4-Matic; exc. Airmatic Suspension	ST-10010	
MERCEDES-BENZ SPORT UTILITY				
GLA250	2015-18	Bearing Only; FWD; exc. Air Suspension	ST-10010	
GLA45 AMG	2014-15	Bearing Only; exc. 4-Matic; exc. Airmatic Suspension	ST-10010	
GLK250	2013-15	Bearing Only; exc. 4-Matic; exc. Airmatic Suspension	ST-10010	
GLK350	2009-15	Bearing Only; exc. 4-Matic; exc. Airmatic Suspension	ST-10010	
MERCURY PASSENGER CAR				
CAPRI	1991-93		ST-2976	ST-1959
	1979-86		ST-1925	
COUGAR	2001-02		ST-2953	
	1999-00		ST-2953	ST-2954
	1992-97	exc Auto Adj Suspension	ST-1970	
		exc Auto Adj Suspension, Lower Spring Isolator	ST-4920	
	1989-91	exc XR7	ST-1970	
		exc XR7, Lower Spring Isolator	ST-4920	
	1987-88		ST-1974	
	1983-86		ST-1971	
	1981-82		ST-1925	
	1980-82	XR7	ST-1971	
GRAND MARQUIS	2003-11		ST-7944	
		Upper Spring Seat	ST-7945	
LN7	1983	after 2/83	ST-1916	
	1982			ST-1956
				ST-1956
LYNX	1986-87		ST-1927	
		Bearing Only	ST-1901	
	1985	after 3/85	ST-1927	
		before 3/85	ST-1916	

Suspension Strut Mounts

Model	Years	Location/ Options	Front	Rear	
MERCURY PASSENGER CAR (continued)					
LYNX	1985	Bearing Only	ST-1901	ST-1956	
	1984		ST-1916	ST-1956	
	1983	after 2/83	ST-1916		
	1981-82			ST-1956 ST-1956	
MARQUIS	1983-86		ST-1925		
MILAN	2006-11		ST-5918		
		Upper Spring Seat & Isolator	ST-6961		
		Lower Spring Isolator	ST-9929		
MONTEGO	2005-07		ST-5915		
		Left Side: AWD		ST-7900	
		Left Side: w/ FWD		ST-6996	
		Right Side: AWD		ST-7901	
		Right Side: w/ FWD		ST-6997	
		Upper Spring Isolator	ST-7948		
		Upper Spring Isolator; AWD		ST-7998	
MYSTIQUE	1995-00		ST-2953	ST-2954	
SABLE	2009		ST-6962		
		Left Side: AWD		ST-7900	
		Left Side: w/ FWD		ST-6998	
		Right Side: AWD		ST-7901	
		Right Side: w/ FWD		ST-6999	
		Upper Spring Isolator	ST-9914		
		Lower Spring Isolator	ST-7999		
			Upper Spring Isolator; AWD	ST-7998	
	2008			ST-6962	
		Left Side: AWD			ST-7900
		Left Side: w/ FWD			ST-6998
		Right Side: AWD			ST-7901
		Right Side: w/ FWD			ST-6999
		Upper Spring Isolator; From 8/13/08	ST-9914		
		Lower Spring Isolator	ST-7999		
			Upper Spring Isolator; AWD	ST-7998	
	1996-05	Sedan		ST-2944	ST-1954
		Station Wagon		ST-2944	
		Upper Spring Seat		ST-3968	
		Lower Spring Isolator		ST-4937	
1986-95	Sedan		ST-1926	ST-1954	
	Station Wagon		ST-1926		
	Bearing Only		ST-1902		
	Upper Spring Seat		ST-3967		
	Lower Spring Isolator		ST-5965		
		after 3/94, Lower Spring Isolator		ST-5964	
TOPAZ	1984-94	AWD	ST-1927		
		FWD	ST-1927	ST-1955	
		Bearing Only	ST-1901		
		Upper Spring Isolator, exc AWD		ST-3966	
TRACER	1997-99	exc ABS Brakes	ST-4913	ST-1963	
		exc ABS Brakes, Upper Spring Seat & Isolator	ST-4936		
		Lower Spring Isolator		ST-4922	
	1991-96		ST-2936	ST-1963	
		Upper Spring Seat & Isolator	ST-3965		
		Lower Spring Isolator		ST-4922	
1987-89		ST-1930	ST-1959		
ZEPHYR	1978-83		ST-1925		

Suspension Strut Mounts

Model	Years	Location/ Options	Front	Rear
MERCURY SPORT UTILITY				
MARINER	2005-11		ST-4938	
		Upper Spring Isolator	ST-7906	
		Upper Spring Seat	ST-7905	
		Lower Spring Isolator	ST-7907	
MOUNTAINEER	2006-10		ST-7937	ST-7940
		Upper Spring Isolator	ST-7939	
		Upper Spring Isolator	ST-7938	ST-7941
	2002-05	Stud Plate Only	ST-6918	ST-6927
		Upper Spring Isolator	ST-6923	ST-6925
		Upper Spring Seat	ST-6924	ST-6926
MERCURY VAN				
MONTEREY	2004-07		ST-4971	
VILLAGER	1999-02		ST-2989	
	1993-98		ST-2989	
		Upper Spring Seat	ST-5921	
		Lower Spring Isolator	ST-5924	
MINI				
COOPER CLUBMAN	2016-18	Bushing Kit		ST-8911
COOPER PACEMAN	2013-16		ST-8910	
		Bushing Kit		ST-8911
COOPER COUNTRYMAN	2011-17		ST-8910	
		Bushing Kit		ST-8911
COOPER	2007-17		ST-8910	
		Bushing Kit		ST-8911
	2002-06		ST-6983	
		Bushing Kit		ST-6984
		Lower Spring Isolator		ST-7969
MITSUBISHI PASSENGER CAR				
3000GT	1991-99	exc adj suspension	ST-2955	ST-2923
CORDIA	1983-88	Hatchback	ST-3948	
DIAMANTE	1997-03		ST-2914	ST-5942
		Lower Spring Isolator	ST-6938	
	1992-96	exc Active Suspension	ST-2914	
		Sedan, exc Active Suspension		ST-5941
ECLIPSE	2006-12		ST-8944	
		Lower Spring Isolator	ST-7965	
	2000-05		ST-4957	
		Stud Plate Only		ST-9947
		Lower Spring Isolator	ST-6938	
		Upper Spring Isolator		ST-9969
	1995-99	Bushing Kit		ST-2923
		Bushing		ST-2923
		Stud Plate Only		ST-9947
			Upper Spring Isolator	
1990-94		ST-2920	ST-2923	
GALANT	2009-12		ST-8944	
	2004-08		ST-8944	
		Lower Spring Isolator	ST-7965	
	1999-03		ST-4957	
		Stud Plate Only		ST-9947
		Lower Spring Isolator	ST-6938	
		Upper Spring Isolator		ST-9969
			Bushing Kit	
1994-98		ST-2923	ST-2923	
	Upper Spring Isolator		ST-7993	

Suspension Strut Mounts

Model	Years	Location/ Options	Front	Rear	
MITSUBISHI PASSENGER CAR (continued)					
GALANT	1985-93	exc Auto leveling system	ST-2977	ST-2923	
LANCER	2009-17	Base Model, FWD	ST-8912		
		Lower Spring Isolator; DE, ES, GTS Models	ST-7966		
	2008	FWD	ST-8912		
		Lower Spring Isolator; w/ FWD	ST-7966		
	2007		ST-5944	ST-5945	
		Lower Spring Isolator		ST-7962	
	2006	ES; Exc. Revolution	ST-5943		
		Exc. ES; Exc. Evolution	ST-5944		
		Exc. Evolution		ST-5945	
		Lower Spring Isolator; Exc. ES Model	ST-7963		
	2004-05	Lower Spring Isolator		ST-7962	
		ES; Exc. Revolution	ST-5943		
		Exc. ES; Exc. Evolution	ST-5944		
		Exc. Evolution		ST-5945	
		Lower Spring Isolator; ES Model	ST-7964		
2002-03	Lower Spring Isolator; Exc. ES Model	ST-7963			
	Lower Spring Isolator		ST-7962		
	ES; Exc. Revolution	ST-5943			
	Exc. ES; Exc. Evolution	ST-5944			
	Exc. Evolution		ST-5945		
MIRAGE	1998-02		ST-3947	ST-2923	
	1997	after 4/97	ST-3947		
		before 4/97	ST-3945		
				ST-2923	
	1993-96		ST-2958	ST-2923	
	1989-92		ST-1977	ST-2923	
	1987-88		ST-2918		
	1985-86		ST-2917		
	PRECIS	1989-94		ST-1938	
		1987-88		ST-1937	
SIGMA	1989-90	exc ABS brakes & Auto leveling system	ST-3946	ST-2923	
STARION	1983-89	exc adj suspension	ST-2961	ST-2962	
TREDIA	1983-88		ST-3948		
MITSUBISHI SPORT UTILITY					
ASX	2013-15		ST-8912		
ENDEAVOR	2004-11		ST-8944		
MONTERO	2001-03	w/o Electronic Suspension	ST-4984		
OUTLANDER	2007-13		ST-8912		
	2003-06		ST-5944		
		Lower Spring Isolator	ST-7964		
OUTLANDER SPORT	2011-19		ST-8912		
MITSUBISHI VAN					
EXPO	1992-95	FWD	ST-1976		
EXPO LRV	1992-94	FWD	ST-1976	ST-2923	
				ST-2923	
NISSAN PASSENGER CAR					
200SX	1995-98		ST-2938	ST-2978	
			ST-5996		
	1984-88		ST-3949		
240SX	1989-98	exc adj suspension	ST-2979	ST-2980	
240Z	1970-73		ST-1947		

Suspension Strut Mounts

Model	Years	Location/ Options	Front	Rear
NISSAN PASSENGER CAR (continued)				
260Z	1974-75		ST-1947	
280Z	1975-78		ST-1947	
280ZX	1979-83		ST-1947	
300ZX	1990-96	exc adj suspension	ST-2985	ST-2978
	1984-89	V6 3.0L 2960cc:w/o Turbo	ST-3951	
		V6 3.0L 2960cc;bearing Only, exc Turbo	ST-1947	
350Z	2003-08		ST-5985	
510	1972-73	Bearing Only	ST-1947	
	1971	after AUG 1	ST-1947	
610	1973-76	bearing Only; Sedan & Wagon	ST-1947	
710	1974-77		ST-1947	
810	1980-81		ST-1947	
ALTIMA	2009-13		ST-8913	
		Lower Spring Isolator	ST-9904	
	2007-08		ST-8913	ST-4985
		Lower Spring Isolator	ST-9904	
	2002-06		ST-6914	ST-4985
		Upper Spring Seat	ST-7904	
		Lower Spring Isolator	ST-6945	
	2000-01		ST-3957	ST-2981
		Lower Spring Isolator		ST-5996
	1993-99		ST-1975	ST-2981
		Upper Spring Seat	ST-6929	
Upper Spring Isolator			ST-5995	
Upper Spring Seat; Right			ST-6931	
Lower Spring Isolator			ST-5996	
Upper Spring Seat; Left		ST-6930		
MAXIMA	2009-14		ST-8913	
	2004-08		ST-6914	
		Lower Spring Isolator	ST-6945	
	2000-03		ST-6914	ST-4979
		Stud Plate Only	ST-8956	
		Upper Spring Isolator	ST-8957	
		Upper Spring Seat	ST-8955	
	1995-99	Mount	ST-3910	
		Stud Plate Only	ST-5962	ST-5939
		Upper Spring Isolator	ST-5978	ST-5979
		Bushing Kit		ST-3911
	1989-94	w/o Sonar Suspension, Left Side	ST-2989	
		w/o Sonar Suspension, Right Side	ST-2989	
		Left Side		ST-2982
		Right Side		ST-2983
	w/o Sonar Suspension, bearing Only - both Sides	ST-1947		
1985-88	exc Elec Control Shocks, Left Side	ST-1948	ST-2982	
	exc Elec Control Shocks, Right Side	ST-1948	ST-2983	
1982-84	Bearing Only	ST-1947		
MULTI	1986-88	2WD & 4WD	ST-2937	
NX	1991-93	exc ABS Brakes	ST-2938	ST-1989
			ST-5996	ST-5996
PLATINA (MEXICO)	2002-10		ST-98002	
PULSAR	1983		ST-2937	
PULSAR NX	1987-90		ST-2937	ST-2937
	1983-86		ST-2937	
SENTRA	2007-12	Base, S, SL, & SR Models; Left Side	ST-8914	
		Base, S, SL, & SR Models; Right Side	ST-8915	
		Lower Spring Isolator	ST-9925	
	2002-06		ST-3950	ST-4955
		Upper Spring Isolator	ST-7903	

Suspension Strut Mounts

Model	Years	Location/ Options	Front	Rear	
NISSAN PASSENGER CAR (continued)					
SENTRA	2002-06	Upper Spring Seat	ST-7902		
	2000-01		ST-3950	ST-4955	
	1996-99		ST-2938	ST-2978	
		Lower Spring Isolator	ST-5996		
	1995			ST-2938	
			B13; Sedan, Coupe & Hatchback		ST-1989
			B14; Sedan, Coupe & Hatchback		ST-2978
		Lower Spring Isolator	ST-5996	ST-5996	
	1993-94			ST-2938	ST-1989
			Lower Spring Isolator	ST-5996	ST-5996
	1991-92		exc Sentra Classic	ST-2938	ST-1989
			Sentra Classic	ST-2937	ST-2937
			ST-5996	ST-5996	
1987-90		B12; Sedan, Coupe & Hatchback	ST-2937	ST-2937	
		Station Wagon w/ 2WD	ST-2937	ST-2937	
		Station Wagon w/ 4WD	ST-2937		
1984-86		ST-2937			
STANZA	1990-92	Left Side	ST-1975	ST-2982	
		Right Side	ST-1975	ST-2983	
	1989	Left Side; Sedan	ST-1948	ST-2982	
		Right Side; Sedan	ST-1948	ST-2983	
	1987-88	Wagon 2WD & 4WD	ST-2937		
		Left Side; Sedan	ST-1948	ST-2982	
		Right Side; Sedan	ST-1948	ST-2983	
1986	Wagon 2WD & 4WD	ST-2937			
TIIDA (MEXICO)	2007-18		ST-8916		
			ST-8917		
VERSA	2007-12		ST-8916		
			ST-8917		
NISSAN SPORT UTILITY					
ARMADA	2005-15		ST-7932		
		Upper Spring Isolator	ST-7933		
MURANO	2009-14		ST-8998		
	2003-07		ST-6914		
			ST-8975		
PATHFINDER	2005-11		ST-7928		
		Upper Spring Isolator	ST-7929		
	2002-04		ST-3954		
	1999-01	Mount & Bearing	ST-3954		
		Stud Plate Only	ST-7978		
		Upper Spring Isolator	ST-7980		
		Upper Spring Seat	ST-7979		
1996-98		ST-3954			
ROGUE	2008-12		ST-8916		
			ST-8917		
NISSAN TRUCK					
FRONTIER	2005-11		ST-7928		
		Upper Spring Isolator	ST-7929		
TITAN	2004-15		ST-7932		
		Upper Spring Isolator	ST-7933		
NISSAN VAN					
AXXESS	1990-94	AWD, Left Side	ST-2989		
		FWD, Left Side	ST-2989	ST-2982	
		AWD, Right Side	ST-2989		
		FWD, Right Side	ST-2989	ST-2983	
QUEST	2011-14		ST-8998		

Suspension Strut Mounts

Model	Years	Location/ Options	Front	Rear
NISSAN VAN (continued)				
QUEST	2004-09		ST-6914	
	1993-02		ST-2989	
OLDSMOBILE PASSENGER CAR				
88	1992-99	exc elec adj suspension	ST-1922	ST-1953
		Bearing Only	ST-1928	
		exc elec suspension - Upper Spr Seat & Isolator	ST-3973	
		exc elec suspension, Lower Spring Isolator	ST-4925	
98	1991-96	Complete Unit	ST-1922	ST-1953
		Bearing Only	ST-1928	
		Upper Spring Seat & Isolator	ST-3973	
		exc elec suspension, Lower Spring Isolator	ST-4925	
	1985-90		ST-1973	ST-1953
		Bearing Only	ST-1928	
ACHIEVA	1995-98	exc elec suspension	ST-4912	ST-1951
		exc elec suspension - Upper Spr Seat & Isolator	ST-3970	
	1992-94		ST-1946	ST-1951
		exc elec suspension - bearing Only	ST-1928	
ALERO	1999-04	exc elec suspension - Upper Spr Seat & Isolator	ST-3972	
			ST-2999	ST-3900
		Upper Spring Isolator	ST-4944	
AURORA	2001-03 1998-99 1995-97	Lower Spring Isolator	ST-4945	
			ST-2972	ST-2998
			ST-2972	ST-2998
			ST-2930	ST-2998
CALAIS	1985-87	Bearing Only	ST-1928	
		Upper Spring Seat & Isolator	ST-3973	
			ST-1913	ST-1951
CUTLASS	1997-99	Upper Spring Seat & Isolator	ST-3969	
		Lower Spring Isolator	ST-4924	
			ST-2999	ST-3900
CUTLASS CALAIS	1988-91	Upper Spring Isolator	ST-4944	
			ST-4945	
			ST-1913	ST-1951
CUTLASS CIERA	1984-96 1982-83	Upper Spring Seat & Isolator	ST-3969	
		Lower Spring Isolator	ST-4924	
			ST-1934	ST-1951
CUTLASS CRUISER CUTLASS SUPREME	1982-83 1988-97	Upper Spring Seat & Isolator	ST-3971	
			ST-1934	
DELTA 88	1988-97	w/ FWD	ST-1921	ST-2941
		Bearing Only	ST-1986	
		Lower Spring Seat & Bearing - Left Side; w/ FWD	ST-2994	
		Lower Spring Seat & Bearing - Right Side; w/ FWD	ST-2995	
	1991		ST-1922	ST-1953
			ST-1928	
1990	exc elec suspension - Upper Spr Seat & Isolator		ST-3973	
		exc elec suspension, Lower Spring Isolator	ST-4925	
	early Design w/ Spring guard	ST-1973		
	late Design w/o Spring guard	ST-1922		
			ST-1953	
	Bearing Only	ST-1928		
Upper Spr Seat & Isolator w/ Spring GUARD	ST-3974			
Upper Spr Seat & Isolator, w/o Spring GUARD	ST-3973			

Suspension Strut Mounts

Model	Years	Location/ Options	Front	Rear
OLDSMOBILE PASSENGER CAR (continued)				
DELTA 88	1990	Lower Spring Isolator: w/ Spring Guard	ST-4923	
		Lower Spring Isolator; w/o Spring Guard	ST-4925	
	1986-89		ST-1973	ST-1953
		Bearing Only	ST-1928	
		Upper Spring Seat & Isolator	ST-3974	
	Lower Spring Isolator	ST-4923		
FIRENZA	1984-88		ST-1913	ST-1951
		Upper Spring Seat & Isolator	ST-3969	
		Lower Spring Isolator	ST-4924	
	1983		ST-1913	
		Upper Spring Seat & Isolator	ST-3969	
		Lower Spring Isolator	ST-4924	
	1982		ST-1913	
	Upper Spring Seat & Isolator	ST-3969		
INTRIGUE	1998-02	Left Side	ST-2973	ST-2969
		Right Side	ST-2973	ST-2968
LSS	1996-99		ST-1922	ST-1953
		Bearing Only	ST-1928	
		Upper Spring Seat & Isolator	ST-3973	
OMEGA	1984		ST-1934	ST-1951
	1982-83		ST-1934	
REGENCY	1997-98	exc elec adj suspension	ST-1922	ST-1953
		exc elec adj suspension - bearing Only	ST-1928	
		exc elec adj suspension - Upper Spr Seat & IsoLATO	ST-3973	
TORONADO	1990-92		ST-2965	ST-2971
		Bearing Only	ST-1928	
	1986-89		ST-1990	ST-2971
OLDSMOBILE SPORT UTILITY				
BRAVADA	2002-04	2WD & 4WD	ST-4968	
	1996-99	Torsion Bar Mount: w/ 4WD	ST-2992	
	1991-94	Torsion Bar Mount: w/ 4WD	ST-2992	
OLDSMOBILE VAN				
SILHOUETTE	1997-04	2WD & AWD	ST-2973	
		Upper Spring Isolator	ST-4942	
		Lower Spring Isolator	ST-4943	
	1990-96	2WD & AWD	ST-1934	ST-1951
		Upper Spring Seat & Isolator	ST-3971	
PLYMOUTH PASSENGER CAR				
ACCLAIM	1989-95		ST-1908	
		Upper Spring Seat & Isolator	ST-4916	
		Lower Spring Isolator	ST-3980	
ARROW	1976-80		ST-1937	
BREEZE	1996-00		ST-1940	ST-2946
CARAVELLE	1987-88	w/ FWD	ST-1908	
		Upper Spring Seat & Isolator	ST-4916	
		Lower Spring Isolator	ST-3980	
	1986	w/ FWD after JAN 1	ST-1908	
		w/ FWD before JAN 1	ST-1907	
		after JAN 1, Upper Spring Seat & Isolator	ST-4916	
		after JAN 1, Lower Spring Isolator	ST-3980	
	1984-85	w/ FWD	ST-1907	
1983	w/ FWD	ST-1906		
CHAMP	1979-82		ST-1937	
COLT	1993-94	Sedan	ST-2958	ST-2923
		VISTA Wagon 2WD	ST-1976	

Suspension Strut Mounts

Model	Years	Location/ Options	Front	Rear
PLYMOUTH PASSENGER CAR (continued)				
COLT	1993-94	Wagon 2WD & 4WD		ST-2923
	1992	Hatchback	ST-1977	
		VISTA Wagon 2WD	ST-1976	ST-2923
		VISTA Wagon 4WD		ST-2923
	1991	Hatchback	ST-1977	
	1989-90	Hatchback	ST-1977	
		Wagon 2WD & 4WD	ST-2918	
	1987-88		ST-2918	
	1985-86	Sedan & Hatchback	ST-2917	
	1984	Sedan & Hatchback	ST-1937	
		Wagon	ST-1992	
	1980-83	Sedan & Hatchback	ST-1937	
	1977-79	Sedan & Hatchback	ST-1937	
Wagon		ST-1992		
1976	Sedan & Wagon	ST-1992		
CONQUEST	1984-86	exc adj suspension	ST-2961	ST-2962
EXPO	1987-89		ST-1905	ST-1952
HORIZON	1978-90		ST-1905	ST-1952
LASER	1994	w/ FWD	ST-2920	ST-2923
	1990-93	w/ FWD	ST-2920	ST-2923
NEON	2000-01		ST-3926	ST-3924
	1995-99		ST-2907	ST-2908
		Upper Spring Seat & Isolator Lower Spring Isolator	ST-3976	
RELIANT	1987-89		ST-1908	
		Upper Spring Seat & Isolator	ST-4916	
		Lower Spring Isolator	ST-3980	
	1986	after JAN 1	ST-1908	
		before JAN 1	ST-1907	
		after JAN 1, Upper Spring Seat & Isolator	ST-4916	
		after JAN 1, Lower Spring Isolator	ST-3980	
	1984-85		ST-1907	
1983		ST-1906		
1981-82		ST-1905		
SAPPORO	1981-83		ST-2963	
	1978-80		ST-1992	
SCAMP	1983		ST-1905	
SUNDANCE	1987-94		ST-1908	
		Upper Spring Seat & Isolator Lower Spring Isolator	ST-4916 ST-3980	
TURISMO	1983-85		ST-1905	ST-1952
PLYMOUTH VAN				
GRAND VOYAGER	1996-00		ST-2945	
		Upper Spring Seat	ST-3975	
		Lower Spring Isolator	ST-4921	
	1995	after MAR 1	ST-2945	
		before MAR 1	ST-1908	
		after MAR 1, Upper Spring Seat	ST-3975	
		before MAR 1, - Upper Spring Seat	ST-4916	
		after MAR 1, Lower Spring Isolator	ST-4921	
		before MAR 1, Lower Spring Isolator	ST-3980	
	1988-94		ST-1908	
Upper Spring Seat & Isolator		ST-4916		
Lower Spring Isolator		ST-3980		
VOYAGER	1996-00		ST-2945	
		Upper Spring Seat	ST-3975	
		Lower Spring Isolator	ST-4921	

Suspension Strut Mounts

Model	Years	Location/ Options	Front	Rear
PLYMOUTH VAN (continued)				
VOYAGER	1995	after MAR 1	ST-2945	
		before MAR 1	ST-1908	
		after MAR 1, Upper Spring Seat	ST-3975	
		before MAR 1, - Upper Spring Seat	ST-4916	
		after MAR 1, Lower Spring Isolator	ST-4921	
	1986-94	before MAR 1, Lower Spring Isolator	ST-3980	
			ST-1908	
		Upper Spring Seat & Isolator	ST-4916	
	1984-85	Lower Spring Isolator	ST-3980	
		ST-1907		
PONTIAC PASSENGER CAR				
6000	1985-91	AWD	ST-1934	
		FWD	ST-1934	ST-1951
		Upper Spring Seat & Isolator	ST-3971	
	1984	w/ HD Suspension, Upper Spring Seat & Isolator	ST-3971	ST-1951
1982-83		ST-1934		
BONNEVILLE	2000-05		ST-2972	ST-2998
	1991-99		ST-1922	ST-1953
		Bearing Only	ST-1928	
		Upper Spring Seat & Isolator	ST-3973	
		exc Computer Command Ride, Lower Spring Isolator	ST-4925	
	1990	w/ Spring Guard	ST-1973	
		w/o Spring Guard	ST-1922	ST-1953
		Bearing Only	ST-1928	
		w/ Spring Guard, Upper Spring Seat & Isolator	ST-3974	
		w/o Spring Guard, Upper Spring Seat & Isolator	ST-3973	
		w/ Spring Guard, Lower Spring Isolator	ST-4923	
		w/o Spring Guard, Lower Spring Isolator	ST-4925	
	1987-89		ST-1973	ST-1953
Bearing Only		ST-1928		
Upper Spring Seat & Isolator		ST-3974		
Lower Spring Isolator		ST-4923		
FIERO	1984-88			ST-2916
FIREBIRD	1993-02	Left Side	ST-2947	
		Right Side	ST-2948	
		Upper Spring Isolator	ST-3933	
		Lower Spring Seat	ST-4962	
	1982-92	Left Side	ST-1924	
		Right Side	ST-1923	
FIREFLY	1995-00		ST-1987	
	1989-91		ST-1987	ST-1988
	1985-88		ST-2933	
G3 Wave	2009		ST-5906	ST-5981
G3	2007-09		ST-5906	ST-5981
G5	2007-09		ST-5907	
G6	2005-10	Left Side	ST-5909	
		Right Side	ST-5908	
				ST-7990
G8	2008-09		ST-3932	
GRAND AM	1999-05		ST-2999	ST-3900
		Upper Spring Isolator	ST-4944	
		Lower Spring Isolator	ST-4945	
	1995-98		ST-4912	ST-1951
		Bearing Only	ST-1928	

Suspension Strut Mounts

Model	Years	Location/ Options	Front	Rear	
PONTIAC PASSENGER CAR (continued)					
GRAND AM	1995-98	Upper Spring Seat & Isolator	ST-3970		
	1992-94		ST-1946	ST-1951	
		Bearing Only	ST-1928		
		Upper Spring Seat & Isolator	ST-3972		
	1985-91		ST-1913	ST-1951	
Upper Spring Seat & Isolator		ST-3969			
Lower Spring Isolator		ST-4924			
GRAND PRIX	2004-08	Left Side, exc w/ 17" or 18" wheels	ST-2973	ST-2969	
		Right Side, exc w/ 17" or 18" wheels	ST-2973	ST-2968	
	1997-03	Left Side	ST-2973	ST-2969	
		Right Side	ST-2973	ST-2968	
		Upper Spring Isolator	ST-4942		
	1988-96	Lower Spring Isolator	ST-4943	ST-4941	
		w/ FWD	ST-1921	ST-2941	
		Lower Spring Seat & Bearing - Left Side; w/ FWD	ST-2994		
		Lower Spring Seat & Bearing - Right Side; w/ FWD	ST-2995		
GTO	2004-06		ST-3932		
J2000	1982-84		ST-1913		
		Upper Spring Seat & Isolator	ST-3969		
		Lower Spring Isolator	ST-4924		
LEMANS	1988-93		ST-1995		
OPTIMA	1988-91		ST-1995		
PHOENIX	1984		ST-1934	ST-1951	
		Upper Spring Seat & Isolator	ST-3971		
	1982-83		ST-1934		
			ST-5907		
PURSUIT	2005-06		ST-7909		
		Upper Spring Isolator	ST-7908		
		Upper Spring Seat	ST-7910		
		Lower Spring Isolator			
SUNBIRD	1992-94		ST-1929	ST-1951	
		Upper Spring Seat & Isolator	ST-3969		
	1985-91		ST-1913	ST-1951	
		Upper Spring Seat & Isolator	ST-3969		
		Lower Spring Isolator	ST-4924		
SUNBURST	1985-88		ST-1932		
SUNFIRE	2000-05		ST-4919	ST-2949	
		Upper Spring Isolator	ST-4939		
		Lower Spring Isolator	ST-4940		
	1999	1st Design	ST-4912		
		2nd Design	ST-4919		
					ST-2949
			Upper Spring Isolator	ST-4939	
			Lower Spring Isolator	ST-4940	
	1995-98		ST-4912	ST-2949	
Bearing Only		ST-1928			
		Lower Spring Isolator	ST-4940		
SUNRUNNER	1994-97		ST-1994		
TEMPEST	1987-91		ST-1929	ST-1951	
		Lower Spring Isolator	ST-4924		
VIBE	2009-10		ST-8942	ST-4990	
	2003-08		ST-4935	ST-4990	
		Upper Spring Seat	ST-7982		
		Upper Spring Seat	ST-7981		
		Lower Spring Isolator	ST-6936		
WAVE	2005-08		ST-5906	ST-5981	

Suspension Strut Mounts

Model	Years	Location/ Options	Front	Rear
PONTIAC SPORT UTILITY				
AZTEK	2001-05	FWD	ST-2973	
		Upper Spring Isolator	ST-4942	
		w/ AWD - Upper Spring Seat & Isolator	ST-3973	
		Lower Spring Isolator	ST-4943	
TORRENT	2007-09		ST-6956	
	2006		ST-5980	
		Upper Spring Isolator	ST-8954	
PONTIAC VAN				
MONTANA	1999-09		ST-2973	
		Upper Spring Isolator	ST-4942	
		Lower Spring Isolator	ST-4943	
TRANS SPORT	1997-98		ST-2973	
		Upper Spring Isolator	ST-4942	
		Lower Spring Isolator	ST-4943	
	1990-96		ST-1934	ST-1951
		Upper Spring Seat & Isolator	ST-3971	
PORSCHE SUV				
MACAN	2015	exc Auto Leveling System		ST-10008
RAM TRUCK				
1500 PICKUP	2011-18	4WD		
DAKOTA	2011			
RAM VAN				
C/V (CARGO VAN)	2012-15		ST-6960	
RENAULT PASSENGER CAR				
ALLIANCE	1983-87		ST-2909	
CLIO (MEXICAN VEHICL	2002-10		ST-98002	
ENCORE	1984-86		ST-2909	
RENAULT VAN				
KANGOO (MEXICO)	2007-09		ST-98002	
SAAB PASSENGER CAR				
9-3	2003-11		ST-6985	
	1999-02		ST-3961	
9-3X	2010-11		ST-6985	
9-5	1999-08		ST-3959	
900	1994-98		ST-3960	
9000	1986-98	exc self leveling system	ST-2987	
SAAB SUV				
9-7X	2005-09		ST-4968	
SATURN PASSENGER CAR				
AURA	2007-09	Left Side	ST-5909	
		Right Side	ST-5908	
				ST-7990
ION	2003-07	Stud Plate Only	ST-8953	
		Upper Spring Seat	ST-8952	
		Bushing Kit	ST-5948	
L100	2001-02		ST-4915	ST-4987
L200	2001-03		ST-4915	ST-4987
L300	2001-05		ST-4915	ST-4987
LS	2000		ST-4915	ST-4987
LS1	2000		ST-4915	ST-4987
LS2	2000		ST-4915	ST-4987
LW1	2000		ST-4915	ST-4987

Suspension Strut Mounts

Model	Years	Location/ Options	Front	Rear
SATURN PASSENGER CAR (continued)				
LW2	2000		ST-4915	ST-4987
LW200	2001-03		ST-4915	ST-4987
LW300	2001-03		ST-4915	ST-4987
SC	1991-92		ST-1950	ST-1964
		Upper Spring Seat	ST-6928	
SC1	1993-02		ST-1950	ST-1964
		Upper Spring Seat	ST-6928	
SC2	1993-02		ST-1950	ST-1964
		Upper Spring Seat	ST-6928	
SL	1991-02		ST-1950	ST-1964
		Upper Spring Seat	ST-6928	
SL1	1991-02		ST-1950	ST-1964
		Upper Spring Seat	ST-6928	
SL2	1991-02		ST-1950	ST-1964
		Upper Spring Seat	ST-6928	
SW1	1993-99		ST-1950	ST-1964
		Upper Spring Seat	ST-6928	
SW2	1993-01		ST-1950	ST-1964
		Upper Spring Seat	ST-6928	
SATURN SUV				
OUTLOOK	2007-10		ST-7986	
		Upper Spring Isolator	ST-9923	
		Lower Spring Isolator	ST-9924	
VUE	2008-10		ST-6956	
	2006-07		ST-5949	
		Upper Spring Isolator	ST-6921	
		Upper Spring Seat	ST-6922	
	2002-05		ST-5949	
SATURN VAN				
RELAY	2005-07		ST-2973	
		Upper Spring Isolator	ST-4942	
		Lower Spring Isolator	ST-4943	
SCION PASSENGER CAR				
IM	2016		ST-6988	
TC	2011-16		ST-6987	
	2005-10		ST-7943	ST-4990
		Upper Spring Isolator	ST-9931	
		Upper Spring Seat	ST-9962	
XA	2004-05		ST-4988	
XD	2008-14		ST-6989	
SCION VAN				
XB	2008-15		ST-6988	
	2004-06		ST-4988	
SEAT PASSENGER CAR				
CORDOBA (MEXICO)	2001-09	REAR		
IBIZA (MEXICO)	2002-18	REAR		
LEON (MEXICO)	2001-19	REAR		
TOLEDO (MEXICO)	2001-06	REAR		

Suspension Strut Mounts

Model	Years	Location/ Options	Front	Rear
SMART				
FORTWO	2008-14		ST-10011	
SUBARU PASSENGER CAR				
DL	1986-89	Coupe, exc 4WD w/ Air Suspension	ST-2913	ST-3985
		Sedan & Wagon, exc 4WD; w/o Air Suspension	ST-2913	ST-3984
	1985	Sedan & Wagon, exc 4WD; w/o Air Suspension	ST-2913	ST-3984
	1980-84	2WD	ST-2931	
4WD		ST-2931		
GL	1986-89	Coupe, Sedan & Wagon, w/o Air Suspension	ST-2913	
		Hatchback	ST-2931	
		Coupe, exc Air Suspension		ST-3985
		Sedan & Wagon, exc Air Suspension		ST-3984
	1985	Hatchback	ST-2931	
		Sedan & Wagon, exc Air Suspension	ST-2913	ST-3984
1980-84	2WD	ST-2931		
	4WD	ST-2931		
IMPREZA	2008-13		ST-8926	
	2004-07		ST-2924	ST-5950
	2002-03	Left Side, exc WXR	ST-2924	ST-3987
		Right Side, exc WXR	ST-2924	ST-3986
		Exc. WRX		ST-6936
	1993-01	2WD	ST-2924	
AWD		ST-2924	ST-3983	
	Lower Spring Isolator		ST-6952	
LEGACY	2010-14		ST-2924	
	2008-09	Exc. Spec. B Model	ST-8926	ST-4934
	2007	Exc. Spec. B Model	ST-8926	ST-4934
	2006	Exc. Spec. B Model	ST-8926	ST-4934
	2005		ST-8926	ST-4934
	2000-04	exc air suspension	ST-2924	ST-4934
	1997-99	AWD, exc air suspension, Left Side	ST-2924	ST-3987
		AWD, exc air suspension, Right Side	ST-2924	ST-3986
		Lower Spring Isolator	ST-6946	ST-6952
	1995-96	2WD, exc air suspension, Left Side	ST-2924	ST-3989
		AWD, exc air suspension, Left Side	ST-2924	ST-3987
		2WD, exc air suspension, Right Side	ST-2924	ST-3988
		AWD, exc air suspension, Right Side	ST-2924	ST-3986
		Lower Spring Isolator	ST-6946	ST-6952
1992-94	2WD, exc air suspension	ST-2924		
	AWD, exc air suspension	ST-2924	ST-3983	
	Lower Spring Isolator	ST-6946	ST-6952	
1990-91	exc air suspension	ST-2924		
	Lower Spring Isolator		ST-6952	
LOYALE	1990-94	2WD & 4WD	ST-2913	ST-3984
XT	1990-91	2WD, exc XT6 & air suspension	ST-2913	ST-3984
		4WD, exc XT6 & air suspension	ST-2913	ST-3985
	1985-89	4WD, exc XT6 & air suspension	ST-2913	ST-3985
		2WD, exc XT6 & air suspension		ST-3984
SUBARU SPORT UTILITY				
BAJA	2003-06		ST-2924	ST-4934
BRAT	1983-87	4WD	ST-2931	
FORESTER	2009-13		ST-8926	
	2006-08	AWD	ST-2924	ST-5950
	2003-05		ST-2924	ST-5950
	1998-02	Left Side	ST-2924	ST-3987
		Right Side	ST-2924	ST-3986
	Lower Spring Isolator	ST-6946		
TRIBECA	2006-14			ST-8918

Suspension Strut Mounts

Model	Years	Location/ Options	Front	Rear
SUBARU SPORT UTILITY (continued)				
OUTBACK	2010-14		ST-2924	
	2005-09		ST-8926	ST-4934
	2000-04		ST-2924	ST-4934
SUZUKI PASSENGER CAR				
AERIO	2002-07		ST-5951	ST-5953
ESTEEM	2000-02		ST-5951	ST-5953
	1995-99		ST-5951	ST-5952
FORENZA	2004-08		ST-8946	ST-8947
RENO	2005-08		ST-8946	ST-8947
SWIFT	2004-08		ST-5906	ST-5981
	1989-01		ST-1987	ST-1988
SUZUKI SPORT UTILITY				
GRAND VITARA	2006-13		ST-8919	
	1999-05	2WD & 4WD	ST-4932	
SIDEKICK	1989-98		ST-1994	
VITARA	1999-04	L4 2.0L & V6 2.5L,*	ST-4932	
	1999-02	L4 1.6L,*	ST-4933	
X-90	1996-98		ST-1994	
XL-7	2007-09		ST-6956	
	2005-06		ST-4932	
SUZUKI TRUCK				
FORSA	1985-88		ST-2933	
TESLA				
S	2016-19	Exc. Air Suspension	ST-10037	
	2012-15	Exc. Air Suspension	ST-10037	
TOYOTA PASSENGER CAR				
AVALON	2006-12	Lower Spring Isolator		ST-8965
			ST-6986	ST-8966
	2004	Left Side	ST-3906	ST-3904
		Right Side	ST-3903	ST-3904
	1997-03	Left Side	ST-3906	ST-3904
		Right Side	ST-3903	ST-3904
		Upper Spring Seat & Isolator	ST-4950	
		Lower Spring Isolator	ST-4951	ST-4953
	1995-96		ST-3991	ST-2927
		Upper Spring Seat & Isolator	ST-4950	
Lower Spring Isolator		ST-4951	ST-4953	
	Upper Spring Isolator		ST-4952	
CAMRY	2007-11		ST-6986	ST-8966
		Lower Spring Isolator	ST-6935	ST-8965
	2004-06		ST-4989	ST-3904
		Lower Spring Isolator	ST-6935	ST-6935
	2002-03		ST-4989	ST-3904
	1997-01	Left Side	ST-3906	ST-3904
		Right Side	ST-3903	ST-3904
		Upper Spring Seat & Isolator	ST-4950	
		Lower Spring Isolator	ST-4951	ST-4953
	1995-96		ST-3991	ST-2927
		Upper Spring Seat & Isolator	ST-4950	
		Lower Spring Isolator	ST-4951	ST-4953
		Upper Spring Isolator		ST-4952
1992-94		ST-2926	ST-2927	
	Upper Spring Isolator	ST-6937	ST-4952	
	Lower Spring Isolator	ST-5997	ST-4953	
1988-91	2WD, exc ABS Brakes	ST-1944	ST-1962	

Suspension Strut Mounts

Model	Years	Location/ Options	Front	Rear
TOYOTA PASSENGER CAR (continued)				
CAMRY	1988-91	4WD, exc ABS Brakes	ST-1944 ST-6936	ST-1958
	1987	exc ABS Brakes	ST-1944 ST-6936	ST-1962
	1983-86		ST-1943	ST-1958
CELICA	2000-05	Lower Spring Isolator	ST-4935 ST-6936	ST-4990
	1994-99		ST-3992	ST-2957
	1990-93	AWD	ST-1979	
		FWD	ST-1979	ST-2957
	1986-89		ST-1979	ST-1958
	1975-85		ST-1993	
COROLLA	2016-17		ST-8942	ST-4990
	2014-15		ST-8942	ST-4990
		Upper Spring Seat	ST-9955	
	2009-13		ST-8942	ST-4990
		Upper Spring Isolator	ST-9956	
		Upper Spring Seat	ST-9955	
		Lower Spring Isolator	ST-9957	
	2003-08		ST-5957	
		Bushing Kit		ST-4990
		Stud Plate; Left Side		ST-8989
		Stud Plate; Right Side		ST-8988
		Upper Spring Isolator	ST-9956	
		Upper Spring Seat	ST-9962	
	1993-02	Lower Spring Isolator	ST-6936	
			ST-5912	ST-2901
		Upper Spring Isolator	ST-5947	
	1989-92	Lower Spring Isolator	ST-5960	ST-5961
		2WD, Wagon	ST-5912	ST-2901
		4WD, Wagon	ST-5912	
		FWD	ST-5912	
		GTS Coupe		ST-2901
	1988	2WD, Wagon	ST-5912	ST-2901
		4WD, Wagon	ST-5912	
		FX & FX16	ST-1943	ST-1958
		GTS Coupe		ST-2901
	1984-87	FWD	ST-1943	ST-1958
		RWD, w/ Power Steering, Left Side	ST-1912	
RWD, w/o Power Steering, Left Side		ST-1910		
RWD, w/ Power Steering, Right Side		ST-1911		
RWD, w/o Power Steering, Right Side		ST-1909		
1982-83	Left Side	ST-1910		
	Right Side	ST-1909		
1980-81		ST-1968		
1975-79		ST-1996		
1974	after AUG 1	ST-1996		
	before AUG 1	ST-1968		
1970-73		ST-1968		
CORONA	1980-82		ST-1993	
CRESSIDA	1989-92		ST-2912	ST-2988
	1985-88		ST-2912	
	1978-82		ST-1948	
ECHO	2000-05	Centered Hole Placement	ST-5900	
		Offset Hole Placement	ST-4988	
MATRIX	2009-13		ST-8942	ST-4990
		Upper Spring Isolator	ST-9956	ST-8990
		Upper Spring Seat	ST-9955	

Suspension Strut Mounts

Model	Years	Location/ Options	Front	Rear
TOYOTA PASSENGER CAR (continued)				
MATRIX	2009-13	Lower Spring Isolator	ST-9957	
	2007-08		ST-4935	
		FWD		ST-4990
		Upper Spring Seat	ST-7982	
		Upper Spring Seat	ST-7981	
	2003-06	Lower Spring Isolator	ST-6936	
			ST-4935	ST-4990
		Upper Spring Seat	ST-7982	
Upper Spring Seat		ST-7981		
	Lower Spring Isolator	ST-6936		
MR2 SPYDER	2000-05		ST-5957	ST-8922
MR2	1991-95		ST-3990	
PASEO	1996-97		ST-1983	ST-2986
		Lower Spring Isolator	ST-6947	
	1995	after AUG 1	ST-1983	ST-2986
		before AUG 1		ST-1984
		Lower Spring Isolator	ST-6947	
	1992-94			ST-1984
PRIUS	2010-15		ST-6987	
		Upper Spring Isolator	ST-9931	
	2004-09		ST-5957	ST-4990
		Upper Spring Isolator	ST-9956	
		Upper Spring Seat	ST-9962	
	2001-03		ST-4991	ST-4990
PRIUS C	2012-13		ST-6989	
PRIUS V	2012-15	Upper Spring Isolator	ST-9931	
PRIUS PLUG-IN	2012-15		ST-6987	
SOLARA	2007-08		ST-4989	ST-8966
				ST-8965
	2004-06		ST-4989	
		Lower Spring Isolator	ST-6935	ST-6935
	1999-03	Left Side	ST-3906	ST-3904
		Right Side	ST-3903	ST-3904
	Upper Spring Seat & Isolator	ST-4950		
	Lower Spring Isolator	ST-4951	ST-4953	
STARLET	1981-84		ST-1968	
SUPRA	1994-98			ST-4902
	1987-93	Exc Toyota Elec Modulated Suspension	ST-3994	ST-3993
	1986	after MAR 1, exc Elec Modulating Suspension	ST-3994	ST-3993
		before MAR 1	ST-2912	
TERCEL	1995-99	Sedan	ST-1983	ST-2986
		Lower Spring Isolator	ST-6947	
	1991-94	Sedan		ST-1984
	1989-90	Sedan & Hatchback	ST-1969	ST-1984
	1987-88	Sedan & Hatchback	ST-1969	ST-1984
		Wagon	ST-1967	ST-1958
	1983-86	4WD, Wagon	ST-1967	
		FWD	ST-1967	ST-1958
	1980-82		ST-1968	
YARIS	2007-13		ST-6989	
TOYOTA SPORT UTILITY				
4RUNNER	2003-11		ST-7922	
	1996-02		ST-4900	
FJ CRUISER	2007-10		ST-7922	
HIGHLANDER	2008-13		ST-6986	
		Left Side		ST-8921
		Right Side		ST-8920

Suspension Strut Mounts

Model	Years	Location/ Options	Front	Rear
TOYOTA SPORT UTILITY (continued)				
HIGHLANDER	2008-13	Upper Spring Isolator; Exc. Air Suspension	ST-9943	
		Upper Spring Seat	ST-9942	
	2004-07	Left Side	ST-4989	ST-5937
		Right Side	ST-4989	ST-5936
		Upper Spring Isolator; Exc. Air Suspension	ST-9943	
2001-03	Upper Spring Seat	ST-9942		
RAV4	2009-12		ST-4989	ST-3904
		Upper Spring Isolator	ST-6987	
	2006-08	1 Piece Assembly	ST-9931	
		2-Piece Assembly	ST-6988	
	1996-05		ST-6987	
Upper Spring Isolator		ST-3995		
	Upper Spring Seat	ST-9940		
SEQUOIA	2008-17		ST-9939	
VENZA	2009-11		ST-7923	
			ST-6986	
TOYOTA TRUCK				
PICKUP	1980-83		ST-1903	
TACOMA	2014-15		ST-7921	
	2005-13	4WD	ST-7921	
		RWD, Base model	ST-9913	
		RWD; Pre-Runner Model	ST-7921	
1995-04	Stud Plate Only	ST-7927		
TUNDRA	2007-16		ST-7923	
		Upper Spring Isolator	ST-7924	
	2000-06	Upper Spring Isolator	ST-7925	
		Upper Spring Isolator	ST-7926	
TOYOTA VAN				
PREVIA	1991-97		ST-1944	
SIENNA	2004-08		ST-4989	
	1998-03	Left Side	ST-3906	
		Right Side	ST-3903	
VOLKSWAGEN PASSENGER CAR				
BEETLE	2012-19	w/o Magnetic Ride Control Suspension	ST-7949	ST-7947
	1998-10		ST-4905	ST-4910
CC	2009-14		ST-7949	ST-8923
CABRIO	1995-02		ST-2906	ST-1966
		Upper Spring Seat		ST-3962
CABRIOLET	1985-93		ST-1903	ST-1966
CORRADO	1993-94		ST-2906	ST-1966
		Upper Spring Seat		ST-3962
	1992	G60	ST-1904	
		SLC, V6	ST-2906	
		Upper Spring Seat		ST-1966
1990-91		ST-1904	ST-1966	
		Upper Spring Seat		ST-3962
DASHER	1974-81		ST-1903	
EOS	2007-11		ST-7949	ST-7947
FOX	1987-93	Sedan	ST-1941	ST-4906
		Station Wagon	ST-1941	
GOLF	2010-15		ST-7949	ST-7947
	1999-07		ST-4905	ST-4910
	1996-98	exc ABS Brakes	ST-2906	ST-1966
		exc ABS Brakes, Upper Spring Seat		ST-3962
1993-95	Exc. GTi	ST-2906	ST-1966	

Suspension Strut Mounts

Model	Years	Location/ Options	Front	Rear	
VOLKSWAGEN PASSENGER CAR (continued)					
GOLF	1993-95	GTI exc ABS Brakes, Upper Spring Seat	ST-1904	ST-1966 ST-3962	
	1985-92	Upper Spring Seat	ST-1904	ST-1966 ST-3962	
GOLF CITY	2007-09		ST-4905	ST-4910	
GTI	2006-14		ST-7949	ST-7947	
JETTA	2006-14		ST-7949	ST-7947	
	2005	From 5/05 To 4/05	ST-7949 ST-4905	ST-7947 ST-4910	
	1999-04		ST-4905	ST-4910	
	1993-98		exc ABS Brakes	ST-2906	ST-1966
			exc ABS Brakes, Upper Spring Seat exc ABS brakes, Upper Spring Isolator	ST-5946	ST-3962 ST-5963
	1985-92		ST-1904	ST-1966	
	1980-84		ST-1903	ST-1966	
PASSAT	2012-15		ST-7949	ST-8923	
	2006-10		ST-7949		
	2001-05		ST-4992	ST-4909	
	1998-00		AWD	ST-4908	
			FWD	ST-4908	ST-4909
	1993-97		ST-2906	ST-2990	
1990-92		ST-1904	ST-2990		
PASSAT CC	2009-10		ST-7949		
POLO (MEXICAN VEHIC	2013-17	REAR			
	2003-07	REAR			
QUANTUM	1982-88		ST-1942	ST-4907	
R32	2008		ST-7949		
RABBIT	2006-09		ST-7949	ST-7947	
	1975-84		ST-1903	ST-1966	
RABBIT CONVERTIBLE	1980-84		ST-1903	ST-1966	
SCIROCCO	1975-89		ST-1903	ST-1966	
SUPER BEETLE	1974-79		ST-1941		
	1973	after AUG 1	ST-1941		
TIGUAN	2009-15		ST-7949	ST-8923	
VOLKSWAGEN TRUCK					
RABBIT PICKUP	1980-83		ST-1903		
VOLKSWAGEN VAN					
ROUTAN	2009-12	exc. NIVOMAT Rear Suspension	ST-6960		
VOLVO PASSENGER CAR					
240	1990-93	exc. NIVOMAT Rear Suspension	ST-1981		
242	1975-84	exc. NIVOMAT Rear Suspension	ST-1981		
244	1975-89	exc. NIVOMAT Rear Suspension	ST-1981		
245	1975-89	exc. NIVOMAT Rear Suspension	ST-1981		
262	1978-81	exc. NIVOMAT Rear Suspension	ST-1981		
	1976	exc. NIVOMAT Rear Suspension	ST-1981		
264	1976-82	exc. NIVOMAT Rear Suspension	ST-1981		
265	1976-81	exc. NIVOMAT Rear Suspension	ST-1981		
740	1985-92		ST-2911		
745	1985		ST-2911		
760	1983-90		ST-2911		
780	1987-91		ST-2911		
850	1993-97	exc. NIVOMAT Rear Suspension	ST-4903	ST-4904	
		Upper Spring Seat, Exc Nivomat Rear Suspension	ST-3978		
940	1991-95		ST-2911		
960	1992-97		ST-2911		

Suspension Strut Mounts

Model	Years	Location/ Options	Front	Rear
VOLVO PASSENGER CAR (continued)				
C30	2007-12		ST-6980	
C70	2008-12		ST-6980	
	2006-07		ST-4903	
		Upper Spring Seat	ST-3978	
	1998-04		ST-4903	ST-4904
		Upper Spring Seat	ST-3978	
DL	1984	exc. NIVOMAT Rear Suspension	ST-1981	
GLE	1984	exc. NIVOMAT Rear Suspension	ST-1981	
S40	2005-11	FWD	ST-6980	
	2004	Base & LSE Model	ST-5959	
		T5 Model	ST-6980	
		Base, i, & LSE Models		ST-6990
	2001-03		ST-5959	ST-6990
	2000	From 4/1/00	ST-5959	
		To 3/31/00	ST-5958	
			ST-6990	
S60	2001-06		ST-4903	
		Upper Spring Seat	ST-3978	
		Lower Spring Isolator	ST-6941	
S70	1998-00	exc Auto Rear Leveling	ST-4903	ST-4904
		Upper Spring Seat exc Auto Rear Leveling	ST-3978	
S80	1999-06	exc. NIVOMAT Rear Suspension	ST-4903	ST-7946
		exc. NIVOMAT Rear Suspension, Upper Spring Seat	ST-3978	
		Lower Spring Isolator	ST-6941	
S90	1997-98		ST-2911	
V40	2001-03		ST-5959	ST-6990
	2000	From 4/1/00	ST-5959	
		To 3/31/00	ST-5958	
				ST-6990
V50	2005-11	FWD	ST-6980	
V70	2001-07	w/o Electronic Suspension	ST-4903	ST-7946
		w/o Electronic Suspension; Upper Spring Seat	ST-3978	
		Lower Spring Isolator	ST-6941	
	1998-00	Upper; Upper Washer		
		w/o Electronic Suspension	ST-4903	
	w/o Electronic Suspension; Upper Spring Seat	ST-3978		
V90	1997-98		ST-2911	
VOLVO SPORT UTILITY				
XC70	2003-07		ST-4903	
XC90	2003-14		ST-4903	
		Upper Spring Seat	ST-3978	

BUYER'S GUIDE

NUMERICAL LISTING - ILLUSTRATIONS

 <p style="text-align: center;">AS-17100 (NEW) AIR SPRING FRONT</p> <p>MERCEDES-BENZ PASSENGER CAR 2003-09</p>	 <p style="text-align: center;">AS-37100 (NEW) AIR STRUT FRONT LEFT</p> <p>MERCEDES-BENZ SPORT UTILITY 2012-19</p>	 <p style="text-align: center;">AS-7000 AIR SPRING REAR</p> <p>FORD PASSENGER CAR 1992-11 LINCOLN PASSENGER CAR 1990-11 MERCURY PASSENGER CAR ... 1990-11</p>	 <p style="text-align: center;">AS-7003L AIR SPRING FRONT LEFT</p> <p>LINCOLN PASSENGER CAR 1995-96</p>
 <p style="text-align: center;">AS-17101 (NEW) AIR SPRING FRONT</p> <p>MERCEDES-BENZ PASSENGER CAR 2004-09</p>	 <p style="text-align: center;">AS-37101 (NEW) AIR STRUT FRONT RIGHT</p> <p>MERCEDES-BENZ SPORT UTILITY 2012-19</p>	 <p style="text-align: center;">AS-7001 AIR SPRING REAR</p> <p>FORD SPORT UTILITY 1997-02 LINCOLN SPORT UTILITY 1998-02</p>	 <p style="text-align: center;">AS-7003R AIR SPRING FRONT RIGHT</p> <p>LINCOLN PASSENGER CAR 1995-96</p>
 <p style="text-align: center;">AS-17102 (NEW) AIR SPRING REAR LEFT</p> <p>MERCEDES-BENZ PASSENGER CAR 2015-20</p>	 <p style="text-align: center;">AS-37102 (NEW) AIR STRUT FRONT LEFT</p> <p>VOLVO SPORT UTILITY 2016-20</p>	 <p style="text-align: center;">AS-7002 AIR SPRING REAR</p> <p>FORD SPORT UTILITY 1997-02 LINCOLN SPORT UTILITY 1998-02</p>	 <p style="text-align: center;">AS-7004 AIR SPRING REAR LEFT</p> <p>LINCOLN PASSENGER CAR 1995-02</p>
 <p style="text-align: center;">AS-17103 (NEW) AIR SPRING REAR RIGHT</p> <p>MERCEDES-BENZ PASSENGER CAR 2015-20</p>	 <p style="text-align: center;">AS-37103 (NEW) AIR STRUT FRONT RIGHT</p> <p>VOLVO SPORT UTILITY 2016-20</p>	 <p style="text-align: center;">AS-7005 AIR SPRING REAR RIGHT</p> <p>LINCOLN PASSENGER CAR 1995-02</p>	

BUYER'S GUIDE

NUMERICAL LISTING - ILLUSTRATIONS

 AS-7006 AIR SPRING REAR LINCOLN PASSENGER CAR 1984-92	 AS-7011 AIR SPRING FRONT MERCEDES-BENZ SPORT UTILITY 2003-12	 AS-7015 AIR SPRING REAR BMW PASSENGER CAR 2006-10	 AS-7020 AIR SPRING REAR LAND ROVER SPORT UTILITY .. 1998-04
 AS-7007 AIR SPRING FRONT LINCOLN PASSENGER CAR 1984-92	 AS-7012 AIR SPRING REAR LEFT BMW PASSENGER CAR 1999-03	 AS-7016 AIR SPRING REAR LAND ROVER SPORT UTILITY .. 2003-12	 AS-7023 AIR SPRING REAR LINCOLN PASSENGER CAR 1993-98
 AS-7010 AIR SPRING FRONT MERCEDES-BENZ PASSENGER CAR 2006-13	 AS-7013 AIR SPRING REAR RIGHT BMW PASSENGER CAR 1999-03	 AS-7017 AIR SPRING REAR LAND ROVER SPORT UTILITY .. 2005-16	 AS-7024 AIR SPRING FRONT LAND ROVER SPORT UTILITY .. 1993-02
 AS-7014 AIR SPRING REAR BMW SPORT UTILITY 2007-14	 AS-7018 AIR SPRING FRONT LAND ROVER SPORT UTILITY .. 2005-16	 AS-7025 AIR SPRING REAR LAND ROVER SPORT UTILITY .. 1993-02	

BUYER'S GUIDE

NUMERICAL LISTING - ILLUSTRATIONS

 <p style="text-align: center;">AS-7027 AIR SPRING REAR</p> <p>AUDI PASSENGER CAR 2005-11</p>	 <p style="text-align: center;">AS-7032 AIR SPRING FRONT</p> <p>LAND ROVER SPORT UTILITY .. 1995-02</p>	 <p style="text-align: center;">AS-7036 AIR SPRING REAR</p> <p>MERCEDES-BENZ PASSENGER CAR 2002-11</p>	 <p style="text-align: center;">AS-7040 AIR SPRING REAR LEFT</p> <p>MERCEDES-BENZ PASSENGER CAR 2010-18</p>
 <p style="text-align: center;">AS-7028 AIR SPRING FRONT LEFT</p> <p>BMW SPORT UTILITY 2000-06</p>	 <p style="text-align: center;">AS-7033 AIR SPRING REAR</p> <p>LAND ROVER SPORT UTILITY .. 1995-02</p>	 <p style="text-align: center;">AS-7037 AIR SPRING REAR LEFT</p> <p>LEXUS SPORT UTILITY 2003-09 TOYOTA SPORT UTILITY 2003-11</p>	 <p style="text-align: center;">AS-7041 AIR SPRING REAR RIGHT</p> <p>MERCEDES-BENZ PASSENGER CAR 2010-18</p>
 <p style="text-align: center;">AS-7029 AIR SPRING FRONT RIGHT</p> <p>BMW SPORT UTILITY 2000-06</p>	 <p style="text-align: center;">AS-7034 (NEW) AIR SPRING REAR LEFT</p> <p>MERCEDES-BENZ PASSENGER CAR 2002-11</p>	 <p style="text-align: center;">AS-7038 AIR SPRING REAR RIGHT</p> <p>LEXUS SPORT UTILITY 2003-09 TOYOTA SPORT UTILITY 2003-11</p>	 <p style="text-align: center;">AS-7043 AIR SPRING FRONT LEFT</p> <p>AUDI SPORTS UTILITY 2007-15 PORSCHE SUV 2003-10 VOLKSWAGEN SPORT UTILITY 2004-10</p>
 <p style="text-align: center;">AS-7030 AIR SPRING REAR</p> <p>BMW PASSENGER CAR 2009-17</p>	 <p style="text-align: center;">AS-7035 (NEW) AIR SPRING REAR RIGHT</p> <p>MERCEDES-BENZ PASSENGER CAR 2002-11</p>	 <p style="text-align: center;">AS-7039 AIR SPRING REAR</p> <p>FORD SPORT UTILITY 2007-14 LINCOLN SPORT UTILITY 2007-14</p>	 <p style="text-align: center;">AS-7044 AIR SPRING FRONT RIGHT</p> <p>AUDI SPORTS UTILITY 2007-15 PORSCHE SUV 2003-10 VOLKSWAGEN SPORT UTILITY 2004-10</p>

BUYER'S GUIDE

NUMERICAL LISTING - ILLUSTRATIONS

AS-7055WS (Continued)

HUMMER 2003-09



**AS-7056
AIR SPRING
REAR**

BUICK SPORT UTILITY 2004-07
 CHEVROLET SPORT UTILITY 2002-09
 GMC SPORT UTILITY 2002-09
 ISUZU SPORT UTILITY 2003-07
 OLDSMOBILE SPORT UTILITY .. 2002-04
 SAAB SUV 2005-09



**AS-7058
AIR SPRING
REAR LEFT**

BMW SPORT UTILITY 2000-06



**AS-7045
AIR SPRING
REAR LEFT**

AUDI SPORTS UTILITY 2007-15
 PORSCHE SUV 2003-10
 VOLKSWAGEN SPORT
 UTILITY 2004-10



**AS-7046
AIR SPRING
REAR RIGHT**

AUDI SPORTS UTILITY 2007-15
 PORSCHE SUV 2003-10
 VOLKSWAGEN SPORT
 UTILITY 2004-10



**AS-7048
AIR SPRING
FRONT**

LAND ROVER SPORT UTILITY .. 1993-95



**AS-7049
AIR SPRING
REAR**

LAND ROVER SPORT UTILITY .. 1993-95



**AS-7050
AIR SPRING
REAR**

LINCOLN PASSENGER CAR 1990-11



**AS-7051
AIR SPRING
FRONT**

FORD SPORT UTILITY 2003-06
 LINCOLN SPORT UTILITY 2003-06



**AS-7052
AIR SPRING
FRONT**

AUDI PASSENGER CAR 2001-05



**AS-7054
AIR SPRING
REAR**

FORD SPORT UTILITY 2003-06
 LINCOLN SPORT UTILITY 2003-06



**AS-7055
AIR SPRING
REAR**

HUMMER 2003-09



**AS-7055WS
AIR SPRING
REAR**

(Continued Next Column)

BUYER'S GUIDE

NUMERICAL LISTING - ILLUSTRATIONS

 <p>AS-7059 AIR SPRING REAR RIGHT</p> <p>BMW SPORT UTILITY 2000-06</p>	 <p>AS-7062 AIR SPRING REAR</p> <p>JEEP SPORT UTILITY 2011-20</p>	 <p>AS-7067 AIR SPRING REAR RIGHT</p> <p>BMW SPORT UTILITY 2000-06</p>	 <p>AS-7071 AIR SPRING REAR LEFT</p> <p>AUDI PASSENGER CAR 2001-05</p>
 <p>AS-7063 AIR SPRING REAR</p> <p>RAM TRUCK 2013-19</p>	 <p>AS-7068 AIR SPRING REAR</p> <p>FORD VAN 1995-03</p>	 <p>AS-7072 AIR SPRING REAR RIGHT</p> <p>AUDI PASSENGER CAR 2001-05</p>	 <p>AS-7069 AIR SPRING REAR</p> <p>FORD TRUCK 1997-04</p>
 <p>AS-7061 AIR SPRING REAR</p> <p>MERCEDES-BENZ PASSENGER CAR 2006-13</p>	 <p>AS-7065 (NEW) AIR SPRING REAR</p> <p>VOLVO PASSENGER CAR 2017-19 VOLVO SPORT UTILITY 2016-20</p>	 <p>AS-7070 AIR SPRING FRONT</p> <p>AUDI PASSENGER CAR 2001-05</p>	 <p>AS-7073 AIR SPRING FRONT LEFT</p> <p>LAND ROVER SPORT UTILITY .. 2003-12</p>
	 <p>AS-7066 AIR SPRING REAR LEFT</p> <p>BMW SPORT UTILITY 2000-06</p>	 <p>AS-7074 AIR SPRING FRONT RIGHT</p> <p>LAND ROVER SPORT UTILITY .. 2003-12</p>	

BUYER'S GUIDE

NUMERICAL LISTING - ILLUSTRATIONS

 <p style="text-align: center;">AS-7075 AIR SPRING REAR LEFT</p> <p>LEXUS SPORT UTILITY 2010-18</p>	 <p style="text-align: center;">AS-7079 AIR SPRING FRONT LEFT</p> <p>MERCEDES-BENZ SPORT UTILITY 2012-16</p>	 <p style="text-align: center;">AS-7083 AIR SPRING REAR</p> <p>PORSCHE 2010-16</p>	 <p style="text-align: center;">AS-7087 AIR SPRING REAR RIGHT</p> <p>AUDI SPORTS UTILITY 2016-17</p>
 <p style="text-align: center;">AS-7076 AIR SPRING REAR RIGHT</p> <p>LEXUS SPORT UTILITY 2010-18</p>	 <p style="text-align: center;">AS-7080 AIR SPRING FRONT RIGHT</p> <p>MERCEDES-BENZ SPORT UTILITY 2012-16</p>	 <p style="text-align: center;">AS-7084 AIR SPRING REAR LEFT</p> <p>AUDI PASSENGER CAR 2012-18</p>	 <p style="text-align: center;">AS-7088 AIR SPRING REAR LEFT</p> <p>KIA SPORT UTILITY 2009-11</p>
 <p style="text-align: center;">AS-7077 AIR SPRING REAR</p> <p>CADILLAC PASSENGER CAR 2013-19</p>	 <p style="text-align: center;">AS-7081 AIR SPRING REAR LEFT</p> <p>PORSCHE SUV 2015-17</p>	 <p style="text-align: center;">AS-7085 AIR SPRING REAR RIGHT</p> <p>AUDI PASSENGER CAR 2012-18</p>	 <p style="text-align: center;">AS-7089 AIR SPRING REAR RIGHT</p> <p>KIA SPORT UTILITY 2009-11</p>
 <p style="text-align: center;">AS-7078 AIR SPRING FRONT</p> <p>JEEP SPORT UTILITY 2011-20</p>	 <p style="text-align: center;">AS-7082 AIR SPRING REAR RIGHT</p> <p>PORSCHE SUV 2015-17</p>	 <p style="text-align: center;">AS-7086 AIR SPRING REAR LEFT</p> <p>AUDI SPORTS UTILITY 2016-17</p>	 <p style="text-align: center;">AS-7090 AIR SPRING REAR</p> <p>LAND ROVER SPORT UTILITY .. 2014-20</p>

BUYER'S GUIDE

NUMERICAL LISTING - ILLUSTRATIONS

 <p style="text-align: center;">AS-7091 AIR SPRING REAR</p> <p>MASERATI SUV 2017-18</p> <p style="text-align: center;">AS-7094 (NEW) AIR SPRING REAR</p> <p>LAND ROVER SPORT UTILITY .. 2013-21</p>	 <p style="text-align: center;">AS-7203WS (NEW) STRUT FRONT</p> <p>CADILLAC SPORT UTILITY 2015-19 CHEVROLET SPORT UTILITY 2015-19 CHEVROLET TRUCK 2014-18 GMC SPORT UTILITY 2015-19 GMC TRUCK 2014-18</p>	 <p style="text-align: center;">AS-7207 (NEW) SHOCK ABSORBER REAR</p> <p>MERCEDES-BENZ SPORT UTILITY 2003-12</p>	<p>AS-7314 (Continued)</p> <p>FORD SPORT UTILITY 2003-06 LINCOLN SPORT UTILITY 2003-06</p>  <p style="text-align: center;">AS-7315 AIR STRUT REAR</p> <p>FORD SPORT UTILITY 2003-06 LINCOLN SPORT UTILITY 2003-06</p>  <p style="text-align: center;">AS-7300 AIR STRUT FRONT LEFT</p> <p>LINCOLN PASSENGER CAR 1993-98</p>  <p style="text-align: center;">AS-7317 AIR STRUT FRONT RIGHT</p> <p>BMW SPORT UTILITY 2000-06</p>
 <p style="text-align: center;">AS-7095 AIR SPRING REAR</p> <p>BMW PASSENGER CAR 2009-12</p>	 <p style="text-align: center;">AS-7204 SHOCK ABSORBER REAR</p> <p>LEXUS SPORT UTILITY 2003-09</p>	 <p style="text-align: center;">AS-7301 AIR STRUT FRONT RIGHT</p> <p>LINCOLN PASSENGER CAR 1993-98</p>	 <p style="text-align: center;">AS-7318 AIR STRUT FRONT LEFT</p> <p>BMW SPORT UTILITY 2000-06</p>
 <p style="text-align: center;">AS-7203 STRUT FRONT</p> <p>CADILLAC SPORT UTILITY 2015-19 CHEVROLET SPORT UTILITY 2015-19 CHEVROLET TRUCK 2014-18 GMC SPORT UTILITY 2015-19 GMC TRUCK 2014-18</p>	 <p style="text-align: center;">AS-7206 (NEW) SHOCK ABSORBER REAR</p> <p>MERCEDES-BENZ SPORT UTILITY 2003-12</p>	 <p style="text-align: center;">AS-7314 AIR STRUT FRONT</p> <p style="text-align: center;">(Continued Next Column)</p>	

BUYER'S GUIDE

NUMERICAL LISTING - ILLUSTRATIONS

 AS-7319 AIR STRUT FRONT MERCEDES-BENZ PASSENGER CAR 2006-13	 AS-7323 AIR STRUT REAR LEFT AUDI PASSENGER CAR 2001-05	 AS-7327 AIR STRUT REAR LAND ROVER SPORT UTILITY .. 2006-13	 AS-7331 AIR STRUT FRONT LEFT MERCEDES-BENZ PASSENGER CAR 2002-09
 AS-7320 AIR STRUT FRONT MERCEDES-BENZ SPORT UTILITY 2003-12	 AS-7324 AIR STRUT REAR RIGHT AUDI PASSENGER CAR 2001-05	 AS-7328 AIR STRUT FRONT LAND ROVER SPORT UTILITY .. 2005-16	 AS-7332 AIR STRUT FRONT RIGHT MERCEDES-BENZ PASSENGER CAR 2002-09
 AS-7321 AIR STRUT FRONT MERCEDES-BENZ SPORT UTILITY 2003-12	 AS-7325 AIR STRUT FRONT LEFT AUDI PASSENGER CAR 2002-10	 AS-7329 AIR STRUT FRONT LEFT LAND ROVER SPORT UTILITY .. 2003-12	 AS-7333 AIR STRUT FRONT MERCEDES-BENZ PASSENGER CAR 2002-06
 AS-7322 AIR STRUT FRONT AUDI PASSENGER CAR 2001-05	 AS-7326 AIR STRUT FRONT RIGHT AUDI PASSENGER CAR 2002-10	 AS-7330 AIR STRUT FRONT RIGHT LAND ROVER SPORT UTILITY .. 2003-12	 AS-7334 AIR STRUT REAR MERCEDES-BENZ PASSENGER CAR 2002-06

BUYER'S GUIDE

NUMERICAL LISTING - ILLUSTRATIONS

 <p style="text-align: center;">AS-7335 AIR STRUT FRONT</p> <p>MERCEDES-BENZ PASSENGER CAR 2007-13</p>	 <p style="text-align: center;">AS-7339 (NEW) AIR STRUT REAR RIGHT</p> <p>BENTLEY 2003-12 VOLKSWAGEN PASSENGER CAR 2004-06</p>	 <p style="text-align: center;">AS-7345 AIR STRUT FRONT RIGHT</p> <p>LAND ROVER SPORT UTILITY .. 2006-12</p>	 <p style="text-align: center;">AS-7349 AIR STRUT FRONT RIGHT</p> <p>MERCEDES-BENZ PASSENGER CAR 2003-06</p>
 <p style="text-align: center;">AS-7336 AIR STRUT REAR LEFT</p> <p>MERCEDES-BENZ PASSENGER CAR 2007-14</p>	 <p style="text-align: center;">AS-7342 AIR SPRING REAR LEFT</p> <p>CADILLAC PASSENGER CAR 2006-11</p>	 <p style="text-align: center;">AS-7346 AIR STRUT FRONT</p> <p>LAND ROVER SPORT UTILITY .. 2006-09</p>	 <p style="text-align: center;">AS-7350 AIR STRUT FRONT LEFT</p> <p>MERCEDES-BENZ SPORT UTILITY 2012-15</p>
 <p style="text-align: center;">AS-7337 AIR STRUT REAR RIGHT</p> <p>MERCEDES-BENZ PASSENGER CAR 2007-14</p>	 <p style="text-align: center;">AS-7343 AIR SPRING REAR RIGHT</p> <p>CADILLAC PASSENGER CAR 2006-11</p>	 <p style="text-align: center;">AS-7347 AIR STRUT FRONT</p> <p>LAND ROVER SPORT UTILITY .. 2006-09</p>	 <p style="text-align: center;">AS-7351 AIR STRUT FRONT RIGHT</p> <p>MERCEDES-BENZ SPORT UTILITY 2012-15</p>
 <p style="text-align: center;">AS-7338 (NEW) AIR STRUT REAR LEFT</p> <p>BENTLEY 2003-12 VOLKSWAGEN PASSENGER CAR 2004-06</p>	 <p style="text-align: center;">AS-7344 AIR STRUT FRONT LEFT</p> <p>LAND ROVER SPORT UTILITY .. 2006-12</p>	 <p style="text-align: center;">AS-7348 AIR STRUT FRONT LEFT</p> <p>MERCEDES-BENZ PASSENGER CAR 2003-06</p>	 <p style="text-align: center;">AS-7352 AIR STRUT REAR LEFT</p> <p>AUDI PASSENGER CAR 2002-10</p>

BUYER'S GUIDE

NUMERICAL LISTING - ILLUSTRATIONS



AS-7353
AIR STRUT
REAR RIGHT

AUDI PASSENGER CAR 2002-10



AS-7356
AIR STRUT
REAR LEFT

AUDI SPORTS UTILITY 2007-15
PORSCHE SUV 2003-10
VOLKSWAGEN SPORT
UTILITY 2004-10



AS-7360
AIR STRUT
REAR

LAND ROVER SPORT UTILITY .. 2006-09



AS-7364
AIR STRUT
FRONT LEFT

AUDI PASSENGER CAR 2005-11



AS-7354
AIR STRUT
FRONT LEFT

AUDI SPORTS UTILITY 2007-15
PORSCHE SUV 2008-10
VOLKSWAGEN SPORT
UTILITY 2004-10



AS-7357
AIR STRUT
REAR RIGHT

AUDI SPORTS UTILITY 2007-15
PORSCHE SUV 2003-10
VOLKSWAGEN SPORT
UTILITY 2004-10



AS-7361
AIR STRUT
FRONT

MERCEDES-BENZ SPORT
UTILITY 2007-11



AS-7365
AIR STRUT
FRONT RIGHT

AUDI PASSENGER CAR 2005-11



AS-7355
AIR STRUT
FRONT RIGHT

AUDI SPORTS UTILITY 2007-15

AIR SPRING

PORSCHE SUV 2008-10

AIR STRUT

VOLKSWAGEN SPORT
UTILITY 2004-10



AS-7358
AIR STRUT
FRONT LEFT

AUDI PASSENGER CAR 2002-10



AS-7362
AIR STRUT
FRONT LEFT

VOLKSWAGEN PASSENGER
CAR 2004-06



AS-7366
AIR STRUT
FRONT RIGHT

BENTLEY 2003-12



AS-7359
AIR STRUT
FRONT RIGHT

AUDI PASSENGER CAR 2002-10



AS-7363
AIR STRUT
FRONT RIGHT

VOLKSWAGEN PASSENGER
CAR 2004-06



AS-7367
AIR STRUT
FRONT LEFT

BENTLEY 2003-12

BUYER'S GUIDE

NUMERICAL LISTING - ILLUSTRATIONS

 AS-7368 AIR STRUT FRONT JAGUAR 2004-09	 AS-7372 AIR STRUT FRONT LEFT MERCEDES-BENZ SPORT UTILITY 2012-16	AS-7376L (NEW) AIR STRUT FRONT LEFT LEXUS PASSENGER CAR 2007-17	AS-7380 AIR STRUT REAR RIGHT TESLA 2012-15 
 AS-7369 AIR STRUT REAR JAGUAR 2004-09	 AS-7373 AIR STRUT FRONT RIGHT MERCEDES-BENZ SPORT UTILITY 2012-16	 AS-7377L (NEW) AIR STRUT REAR LEFT LEXUS PASSENGER CAR 2007-17	AS-7381 (NEW) AIR STRUT FRONT LEFT PORSCHE SUV 2011-16 VOLKSWAGEN SPORT UTILITY 2011-16 
 AS-7370 AIR STRUT FRONT LEFT JEEP SPORT UTILITY 2011-20	 AS-7374 AIR STRUT FRONT LEFT MERCEDES-BENZ SPORT UTILITY 2012-16	 AS-7377R (NEW) AIR STRUT REAR RIGHT LEXUS PASSENGER CAR 2007-17	AS-7382 (NEW) AIR STRUT FRONT RIGHT PORSCHE SUV 2011-16 VOLKSWAGEN SPORT UTILITY 2011-16 
 AS-7371 AIR STRUT FRONT RIGHT JEEP SPORT UTILITY 2011-20	 AS-7375 AIR STRUT FRONT RIGHT MERCEDES-BENZ SPORT UTILITY 2012-16	 AS-7378 AIR STRUT FRONT TESLA 2012-15	 AS-7383 (NEW) AIR STRUT REAR LEFT PORSCHE SUV 2011-16 VOLKSWAGEN SPORT UTILITY 2011-16
		AS-7379 AIR STRUT REAR LEFT TESLA 2012-15	

BUYER'S GUIDE

NUMERICAL LISTING - ILLUSTRATIONS

 <p style="text-align: center;">AS-7384 (NEW) AIR STRUT REAR RIGHT</p> <p>PORSCHE SUV 2011-16 VOLKSWAGEN SPORT UTILITY 2011-16</p>	 <p style="text-align: center;">AS-7392 (NEW) AIR STRUT FRONT</p> <p>RAM TRUCK 2013-19</p>	 <p style="text-align: center;">AS-7397 (NEW) AIR STRUT FRONT RIGHT</p> <p>MERCEDES-BENZ PASSENGER CAR 2003-11</p>	 <p style="text-align: center;">AS-7402 AIR SHOCK REAR RIGHT</p> <p>FORD SPORT UTILITY 1995-99</p>
 <p style="text-align: center;">AS-7385 (NEW) AIR STRUT REAR LEFT</p> <p>BMW PASSENGER CAR 2002-09</p>	 <p style="text-align: center;">AS-7394 (NEW) AIR STRUT REAR LEFT</p> <p>BMW PASSENGER CAR 2002-09</p>	 <p style="text-align: center;">AS-7398 (NEW) AIR STRUT FRONT LEFT</p> <p>LEXUS PASSENGER CAR 2008-17</p>	 <p style="text-align: center;">AS-7403 AIR SHOCK REAR LEFT</p> <p>FORD SPORT UTILITY 1995-99</p>
 <p style="text-align: center;">AS-7386 (NEW) AIR STRUT REAR RIGHT</p> <p>BMW PASSENGER CAR 2002-09</p>	 <p style="text-align: center;">AS-7395 (NEW) AIR STRUT REAR RIGHT</p> <p>BMW PASSENGER CAR 2002-09</p>	 <p style="text-align: center;">AS-7400 AIR SHOCK FRONT</p> <p>FORD SPORT UTILITY 1997-02 LINCOLN SPORT UTILITY 1998-02</p>	 <p style="text-align: center;">AS-7404 AIR SHOCK REAR</p> <p>BUICK VAN 2005-07 CHEVROLET VAN 1997-09 OLDSMOBILE VAN 1997-04 PONTIAC SPORT UTILITY 2001-05 PONTIAC VAN 1997-09 SATURN VAN 2005-07</p>
 <p style="text-align: center;">AS-7391 (NEW) AIR STRUT FRONT</p> <p>LAND ROVER SPORT UTILITY .. 2010-13</p>	 <p style="text-align: center;">AS-7396 (NEW) AIR STRUT FRONT LEFT</p> <p>MERCEDES-BENZ PASSENGER CAR 2003-11</p>	 <p style="text-align: center;">AS-7401 AIR SHOCK FRONT</p> <p>FORD SPORT UTILITY 1995-99</p>	

BUYER'S GUIDE

NUMERICAL LISTING - ILLUSTRATIONS

 <p style="text-align: center;">AS-7405 AIR SHOCK REAR</p> <p>CADILLAC SPORT UTILITY 2002-14 CHEVROLET SPORT UTILITY 2000-14 GMC SPORT UTILITY 2000-14</p>	 <p style="text-align: center;">AS-7408 AIR SHOCK REAR</p> <p>CADILLAC SPORT UTILITY 2015-19 CHEVROLET SPORT UTILITY 2015-19 CHEVROLET TRUCK 2014-18 GMC SPORT UTILITY 2015-19 GMC TRUCK 2014-18</p>	 <p style="text-align: center;">AS-7901 AIR SPRING REAR</p> <p>MERCEDES-BENZ VAN 2009-13</p>	 <p style="text-align: center;">CD-7702 COMPRESSOR DRYER</p> <p>LINCOLN PASSENGER CAR 1995-02</p>
 <p style="text-align: center;">AS-7406 AIR SHOCK REAR</p> <p>CADILLAC SPORT UTILITY 2002-14 CHEVROLET SPORT UTILITY 2000-14 GMC SPORT UTILITY 2000-14</p>	 <p style="text-align: center;">AS-7410 (NEW) AIR SHOCK REAR</p> <p>CADILLAC PASSENGER CAR 2005-15 CADILLAC SPORT UTILITY 2004-09</p>	 <p style="text-align: center;">AS-7906 (NEW) CAB AIR SHOCK</p> <p>INTERNATIONAL MEDIUM/HEAVY DUTY TRUCK 2008-17</p>	 <p style="text-align: center;">CD-7703 COMPRESSOR DRYER</p> <p>LINCOLN PASSENGER CAR 1988-94</p>
 <p style="text-align: center;">AS-7407 SHOCK ABSORBER FRONT</p> <p>CADILLAC SPORT UTILITY 2002-06 CHEVROLET SPORT UTILITY 2000-06 GMC SPORT UTILITY 2000-06</p>	 <p style="text-align: center;">AS-7900 AIR SPRING REAR</p> <p>MERCEDES-BENZ VAN 1996-03</p>	 <p style="text-align: center;">CD-7700 COMPRESSOR DRYER</p> <p>FORD PASSENGER CAR 1992-11 LINCOLN PASSENGER CAR 1990-11 MERCURY PASSENGER CAR ... 1990-11</p>	 <p style="text-align: center;">CD-7704 COMPRESSOR DRYER</p> <p>LINCOLN PASSENGER CAR 1984-92</p>
 <p style="text-align: center;">AS-7407 SHOCK ABSORBER FRONT</p> <p>CADILLAC SPORT UTILITY 2002-06 CHEVROLET SPORT UTILITY 2000-06 GMC SPORT UTILITY 2000-06</p>	 <p style="text-align: center;">AS-7900 AIR SPRING REAR</p> <p>MERCEDES-BENZ VAN 1996-03</p>	 <p style="text-align: center;">CD-7701 COMPRESSOR DRYER</p> <p>LINCOLN PASSENGER CAR 1998-02</p>	 <p style="text-align: center;">CD-7705 COMPRESSOR DRYER</p> <p>FORD SPORT UTILITY 1997-06 FORD TRUCK 2000-04 LINCOLN SPORT UTILITY 1998-06 LINCOLN TRUCK 2002-03</p>

BUYER'S GUIDE

NUMERICAL LISTING - ILLUSTRATIONS



**CD-7708
AIR COMPRESSOR**

LINCOLN PASSENGER CAR 1993-98

**CD-7712
COMPRESSOR
DRYER**

BUICK VAN 2005-07
 CHEVROLET VAN 1997-09
 OLDSMOBILE VAN 1997-04
 PONTIAC VAN 1997-05
 SATURN VAN 2005-07



**CD-7713
AIR COMPRESSOR
COMPRESSOR
DRYER**

CADILLAC SPORT UTILITY 2002-14

CHEVROLET SPORT UTILITY 2000-14
 GMC SPORT UTILITY 2000-14



**CD-7714
COMPRESSOR
DRYER**

BUICK PASSENGER CAR 1997-05
 CADILLAC PASSENGER CAR 1998-05
 OLDSMOBILE PASSENGER
 CAR 1997-03
 PONTIAC PASSENGER CAR 2000-05



**CD-7717
COMPRESSOR
DRYER**

CADILLAC PASSENGER CAR 1993-02



**CD-7718
COMPRESSOR
DRYER**

BUICK PASSENGER CAR 2006-11
 CADILLAC PASSENGER CAR 2006-11



**CD-7719
COMPRESSOR
DRYER**

BUICK PASSENGER CAR 1991-95
 CADILLAC PASSENGER CAR 1985-93
 OLDSMOBILE PASSENGER
 CAR 1987-95
 PONTIAC PASSENGER CAR 1991-95



**CD-7720
COMPRESSOR
DRYER**

BUICK PASSENGER CAR 1996-99
 OLDSMOBILE PASSENGER
 CAR 1996-99
 PONTIAC PASSENGER CAR 1996-99



**CD-7722
COMPRESSOR
DRYER**

FORD SPORT UTILITY 2007-18
 LINCOLN SPORT UTILITY 2007-18



**CD-7723
COMPRESSOR
DRYER**

PORSCHE SUV 2003-10
 VOLKSWAGEN SPORT
 UTILITY 2004-10



**CD-7724
AIR COMPRESSOR**

BMW PASSENGER CAR 1999-09
 BMW SPORT UTILITY 2000-06



**CD-7725
AIR COMPRESSOR**

BMW SPORT UTILITY 2000-06

**CD-7726
AIR COMPRESSOR**

BMW SPORT UTILITY 2007-14



**CD-7727
AIR COMPRESSOR
COMPRESSOR
DRYER**

MAYBACH 2003-11
 MERCEDES-BENZ
 PASSENGER CAR 2000-11

BUYER'S GUIDE

NUMERICAL LISTING - ILLUSTRATIONS

 <p style="text-align: center;">CD-7728 COMPRESSOR DRYER</p> <p>MERCEDES-BENZ PASSENGER CAR 2007-14</p>	 <p style="text-align: center;">CD-7732 COMPRESSOR DRYER</p> <p>AUDI PASSENGER CAR 2001-05</p>	 <p style="text-align: center;">CD-7736 AIR COMPRESSOR</p> <p>AUDI SPORTS UTILITY 2007-15</p>	 <p style="text-align: center;">CD-7740 COMPRESSOR DRYER</p> <p>HUMMER 2008-09</p>
 <p style="text-align: center;">CD-7729 COMPRESSOR DRYER</p> <p>MERCEDES-BENZ PASSENGER CAR 2006-13</p>	 <p style="text-align: center;">CD-7733 AIR COMPRESSOR</p> <p>AUDI PASSENGER CAR 2005-11</p>	 <p style="text-align: center;">CD-7737 AIR COMPRESSOR</p> <p>LAND ROVER SPORT UTILITY .. 1995-02</p>	 <p style="text-align: center;">CD-7741 AIR COMPRESSOR</p> <p>LAND ROVER SPORT UTILITY .. 2005-14</p>
 <p style="text-align: center;">CD-7730 COMPRESSOR DRYER</p> <p>MERCEDES-BENZ PASSENGER CAR 2006-13</p>	 <p style="text-align: center;">CD-7734 COMPRESSOR DRYER</p> <p>AUDI PASSENGER CAR 2002-10</p>	 <p style="text-align: center;">CD-7738 COMPRESSOR DRYER</p> <p>CADILLAC PASSENGER CAR 2006-11</p>	 <p style="text-align: center;">CD-7742 AIR COMPRESSOR</p> <p>LAND ROVER SPORT UTILITY .. 1998-12</p>
 <p style="text-align: center;">CD-7731 COMPRESSOR DRYER</p> <p>MERCEDES-BENZ SPORT UTILITY 2003-12</p>	 <p style="text-align: center;">CD-7735 COMPRESSOR DRYER</p> <p>AUDI PASSENGER CAR 2005-09</p>	 <p style="text-align: center;">CD-7739 COMPRESSOR DRYER</p> <p>HUMMER 2003-07</p>	 <p style="text-align: center;">CD-7743 AIR COMPRESSOR</p> <p>JAGUAR 2004-09</p>

BUYER'S GUIDE

NUMERICAL LISTING - ILLUSTRATIONS



**CD-7744
AIR COMPRESSOR**

BENTLEY 2003-12
VOLKSWAGEN PASSENGER
CAR 2004-06



**CD-7748
AIR COMPRESSOR**

AUDI PASSENGER CAR 2012-18



**CD-7754
AIR COMPRESSOR**

PORSCHE SUV 2011-16
VOLKSWAGEN SPORT
UTILITY 2011-16



**CD-7758
AIR COMPRESSOR**

LEXUS SPORT UTILITY 2010-18



**CD-7745
AIR COMPRESSOR**

BMW PASSENGER CAR 2009-17



**CD-7751
AIR COMPRESSOR**

LEXUS SPORT UTILITY 2003-09
TOYOTA SPORT UTILITY 2003-11



**CD-7755
AIR COMPRESSOR**

PORSCHE 2010-16



**CD-7759
AIR COMPRESSOR**

KIA SPORT UTILITY 2009-11



**CD-7746
AIR COMPRESSOR**

MERCEDES-BENZ
PASSENGER CAR 2010-18



**CD-7752
AIR COMPRESSOR**

CADILLAC PASSENGER CAR 2005-11
CADILLAC SPORT UTILITY 2004-09



**CD-7756
COMPRESSOR
DRYER**

LAND ROVER SPORT UTILITY .. 2013-21



**CD-7760
AIR COMPRESSOR**

CADILLAC SPORT UTILITY 2015-19
CHEVROLET SPORT UTILITY 2015-19
CHEVROLET TRUCK 2014-18
GMC SPORT UTILITY 2015-19
GMC TRUCK 2014-18



**CD-7747
AIR COMPRESSOR**

LAND ROVER SPORT UTILITY .. 2003-05



**CD-7753
AIR COMPRESSOR**

MERCEDES-BENZ SPORT
UTILITY 2012-19



**CD-7757
AIR COMPRESSOR**

JEEP SPORT UTILITY 2011-20
RAM TRUCK 2013-19
TESLA 2012-15



**CD-7762 (NEW)
AIR COMPRESSOR**

VOLVO PASSENGER CAR 2017-19
VOLVO SPORT UTILITY 2016-20

BUYER'S GUIDE

NUMERICAL LISTING - ILLUSTRATIONS



CD-7763
AIR COMPRESSOR

INFINITI SPORT UTILITY 2004-13
NISSAN SPORT UTILITY 2005-15



CD-7765 (NEW)
AIR COMPRESSOR

LEXUS SPORT UTILITY 2004-09



CD-7767 (NEW)
AIR COMPRESSOR

TOYOTA SPORT UTILITY 2008-19

CD-7768 (NEW)
AIR COMPRESSOR

TOYOTA SPORT UTILITY 2005-06

CD-7769 (NEW)
AIR COMPRESSOR

LEXUS PASSENGER CAR 2007-17
TOYOTA SPORT UTILITY 2007

CD-7772 (NEW)
AIR COMPRESSOR

MERCURY PASSENGER CAR ... 2003-04



CK-7603
AIR
COIL SPRING CONVERSION K

CHEVROLET VAN 1990-96
OLDSMOBILE VAN 1990-96
PONTIAC VAN 1990-96



CK-7608
AIR
COIL SPRING CONVERSION K

CADILLAC PASSENGER CAR 1993-95



CK-7609
AIR
COIL SPRING CONVERSION K

CADILLAC PASSENGER CAR 1994-00



CK-7610
AIR
COIL SPRING CONVERSION K

CADILLAC PASSENGER CAR 1994-02



CK-7611
AIR
COIL SPRING CONVERSION K

CADILLAC PASSENGER CAR 1986-92



CK-7612
AIR
COIL SPRING CONVERSION K

CADILLAC PASSENGER CAR 1986-92



CK-7613
AIR
COIL SPRING CONVERSION K

(Continued Next Column)

CK-7613 (Continued)

BUICK PASSENGER CAR 1985-99
CADILLAC PASSENGER CAR 1985-93
OLDSMOBILE PASSENGER
CAR 1991-99
PONTIAC PASSENGER CAR 1991-99



CK-7614
AIR
COIL SPRING CONVERSION K

CADILLAC PASSENGER CAR 1985-93



CK-7615
AIR
COIL SPRING CONVERSION K

BUICK PASSENGER CAR 1995-11
CADILLAC PASSENGER CAR 1998-11
OLDSMOBILE PASSENGER
CAR 1995-03
PONTIAC PASSENGER CAR 2000-05



CK-7616
AIR
COIL SPRING CONVERSION K

BUICK PASSENGER CAR 1995-11
CADILLAC PASSENGER CAR 1998-11
OLDSMOBILE PASSENGER
CAR 1995-03
PONTIAC PASSENGER CAR 2000-05

BUYER'S GUIDE

NUMERICAL LISTING - ILLUSTRATIONS



CK-7617
AIR
COIL SPRING CONVERSION K
CADILLAC PASSENGER CAR 1997-02



CK-7619
AIR
COIL SPRING CONVERSION K
CADILLAC SPORT UTILITY 1999-00



CK-7620
AIR
COIL SPRING CONVERSION K
CADILLAC PASSENGER CAR 1985-90



CK-7621
AIR
COIL SPRING CONVERSION K
CADILLAC PASSENGER CAR 1991-96



CK-7622
AIR
COIL SPRING CONV KT [FRON
CADILLAC PASSENGER CAR 1991-93



CK-7623
AIR
COIL SPRING CONVERSION K
CADILLAC PASSENGER CAR 1997-01



CK-7624
AIR
COIL SPRING CONVERSION K
CADILLAC PASSENGER CAR 1999



CK-7625
AIR
COIL SPRING CONVERSION K
CADILLAC PASSENGER CAR 1991-93



CK-7626
AIR
COIL SPRING CONVERSION K
BUICK SPORT UTILITY 2004-07
CHEVROLET SPORT UTILITY ... 2002-09
GMC SPORT UTILITY 2002-09
ISUZU SPORT UTILITY 2003-07
OLDSMOBILE SPORT UTILITY .. 2002-04
SAAB SUV 2005-09



CK-7626WS
AIR
COIL SPRING CONVERSION K
BUICK SPORT UTILITY 2004-07
CHEVROLET SPORT UTILITY ... 2002-09
GMC SPORT UTILITY 2002-09
ISUZU SPORT UTILITY 2003-07
OLDSMOBILE SPORT UTILITY .. 2002-04
SAAB SUV 2005-09



CK-7627
AIR
COIL SPRING CONV KT [FRON
CADILLAC SPORT UTILITY 2002-06
CHEVROLET SPORT UTILITY ... 2000-06
GMC SPORT UTILITY 2000-06

CK-7628
AIR
COIL SPRING CONV KT [FRON
CADILLAC SPORT UTILITY 2007-14
CHEVROLET SPORT UTILITY ... 2007-14
GMC SPORT UTILITY 2007-14



CK-7629
AIR
COIL SPRING CONVERSION K
CHEVROLET SPORT UTILITY ... 2002-06
GMC SPORT UTILITY 2002-06



CK-7630
AIR
COIL SPRING CONVERSION K
CHRYSLER VAN 2008-09
DODGE VAN 2008-09



CK-7631
AIR
COIL SPRING CONVERSION K
CHRYSLER VAN 2010-16
DODGE VAN 2010-16



CK-7632
AIR
COIL SPRING CONVERSION K
BUICK PASSENGER CAR 1985-90

(Continued Next Page)

BUYER'S GUIDE

NUMERICAL LISTING - ILLUSTRATIONS

CK-7632 (Continued)

CADILLAC PASSENGER CAR 1985-90
 OLDSMOBILE PASSENGER
 CAR 1985-90
 PONTIAC PASSENGER CAR 1987-90



CK-7633

**AIR
 COIL SPRING CONVERSION K**

BUICK PASSENGER CAR 1989-93
 CADILLAC PASSENGER CAR 1989-96
 OLDSMOBILE PASSENGER
 CAR 1990-92

CK-7634

**AIR
 COIL SPRING CONVERSION K**

CADILLAC PASSENGER CAR 2000-05



CK-7635

**AIR
 COIL SPRING CONVERSION K**

CADILLAC PASSENGER CAR 1998-04
 OLDSMOBILE PASSENGER
 CAR 1997-99

CK-7636

**AIR
 COIL SPRING CONVERSION K**

CADILLAC PASSENGER CAR 1997-02



CK-7639 (NEW)

**AIR
 COIL SPRING CONVERSION K**

CADILLAC SPORT UTILITY 2007-14

(Continued Next Column)

CK-7639 (Continued)

CHEVROLET SPORT UTILITY 2007-14
 GMC SPORT UTILITY 2007-14



CK-7640 (NEW)

**AIR
 COIL SPRING CONVERSION K**

CADILLAC SPORT UTILITY 2007-14
 CHEVROLET SPORT UTILITY 2007-14
 GMC SPORT UTILITY 2007-14



CK-7800

**AIR
 COIL SPRING CONVERSION K**

FORD PASSENGER CAR 1992-11
 LINCOLN PASSENGER CAR 1990-11
 MERCURY PASSENGER CAR 1990-11



CK-7800WS

**AIR
 COIL SPRING CONVERSION K**

FORD PASSENGER CAR 1992-02
 LINCOLN PASSENGER CAR 1990-02



CK-7803

**AIR
 COIL SPRING CONVERSION K**

LINCOLN PASSENGER CAR 1995-02



CK-7803WS

**AIR
 COIL SPRING CONVERSION K**

LINCOLN PASSENGER CAR 1997-02



CK-7808

**AIR
 COIL SPRING CONVERSION K**

FORD SPORT UTILITY 1997-02
 LINCOLN SPORT UTILITY 1998-02



CK-7808WS

**AIR
 COIL SPRING CONVERSION K**

FORD SPORT UTILITY 1997-02
 LINCOLN SPORT UTILITY 1998-02



CK-7809

**AIR
 COIL SPRING CONVERSION K**

FORD SPORT UTILITY 1997-02
 LINCOLN SPORT UTILITY 1998-02



CK-7809WS

**AIR
 COIL SPRING CONVERSION K**

FORD SPORT UTILITY 1997-02
 LINCOLN SPORT UTILITY 1998-02



CK-7810

**AIR
 COIL SPRING CONVERSION K**

LAND ROVER SPORT UTILITY .. 1998-04



CK-7811

**AIR
 COIL SPRING CONVERSION K**

FORD VAN 1995-98

BUYER'S GUIDE

NUMERICAL LISTING - ILLUSTRATIONS



CK-7813
AIR
COIL SPRING CONVERSION K

LINCOLN PASSENGER CAR 1997-02



CK-7815
AIR
COIL SPRING CONVERSION K

FORD SPORT UTILITY 1997-02
LINCOLN SPORT UTILITY 1998-02



CK-7816
AIR
COIL SPRING CONVERSION K

FORD SPORT UTILITY 2003-06
LINCOLN SPORT UTILITY 2003-06



CK-7817
AIR
COIL SPRING CONVERSION K

FORD SPORT UTILITY 2003-06
LINCOLN SPORT UTILITY 2003-06



CK-7819
AIR
COIL SPRING CONVERSION K

FORD SPORT UTILITY 1995-03
MERCURY SPORT UTILITY 1997-01



CK-7821
AIR
COIL SPRING CONVERSION K

LINCOLN PASSENGER CAR 1984-92



CK-7821WS
AIR
COIL SPRING CONVERSION K

LINCOLN PASSENGER CAR 1984-92



CK-7822
AIR
COIL SPRING CONVERSION K

(Continued Next Column)

CK-7822 (Continued)

FORD VAN 1999-03



CK-7823
AIR
COIL SPRING CONVERSION K

LINCOLN PASSENGER CAR 1995-96



CK-7824
AIR
COIL SPRING CONVERSION K

LINCOLN PASSENGER CAR 1988-94



CK-7826
AIR
COIL SPRING CONVERSION K

LINCOLN PASSENGER CAR 1993-98



CK-7827
AIR
COIL SPRING CONVERSION K

LAND ROVER SPORT UTILITY .. 1995-02



CK-7828
AIR
COIL SPRING CONVERSION K

LAND ROVER SPORT UTILITY .. 1993-95



CK-7831
AIR
COIL SPRING CONVERSION K

LINCOLN PASSENGER CAR 1984-92

BUYER'S GUIDE

NUMERICAL LISTING - ILLUSTRATIONS

 <p>CK-7831WS AIR COIL SPRING CONVERSION K LINCOLN PASSENGER CAR 1984-92</p>	 <p>CK-7837 AIR COIL SPRING CONVERSION K LAND ROVER SPORT UTILITY .. 1995-02</p>	 <p>CK-7840 AIR COIL SPRING CONVERSION K FORD SPORT UTILITY 1995-03 MERCURY SPORT UTILITY 1997-01</p>	 <p>CK-7843 AIR COIL SPRING CONVERSION K LINCOLN PASSENGER CAR 1990-11</p>
 <p>CK-7834 AIR COIL SPRING CONVERSION K LINCOLN PASSENGER CAR 1988-94</p>	 <p>CK-7838 AIR COIL SPRING CONVERSION K LAND ROVER SPORT UTILITY .. 1993-95</p>	 <p>CK-7841WS AIR COIL SPRING CONVERSION K FORD PASSENGER CAR 2003-11 LINCOLN PASSENGER CAR 2003-11 MERCURY PASSENGER CAR ... 1990-11</p>	 <p>CK-7844WS AIR COIL SPRING CONV KT [FRON LINCOLN PASSENGER CAR 1984-92</p>
 <p>CK-7836 AIR COIL SPRING CONVERSION K LINCOLN PASSENGER CAR 1993-98</p>	 <p>CK-7839 AIR COIL SPRING CONVERSION K HUMMER 2003-09</p>	 <p>CK-7842 AIR COIL SPRING CONV KT [FRON LINCOLN PASSENGER CAR 1997-02</p>	 <p>CK-7845 AIR COIL SPRING CONV KT [FRON LINCOLN PASSENGER CAR 1993-98</p>
 <p>CK-7836WS AIR COIL SPRING CONVERSION K LINCOLN PASSENGER CAR 1993-98</p>	 <p>CK-7839WS AIR COIL SPRING CONVERSION K HUMMER 2003-09</p>	 <p>CK-7842WS AIR COIL SPRING CONV KT [FRON LINCOLN PASSENGER CAR 1997-02</p>	 <p>CK-7845WS AIR COIL SPRING CONV KT [FRON LINCOLN PASSENGER CAR 1993-98</p>

BUYER'S GUIDE

NUMERICAL LISTING - ILLUSTRATIONS



CK-7846
AIR
COIL SPRING CONV KT [FRON
FORD SPORT UTILITY 2003-06
LINCOLN SPORT UTILITY 2003-06



CK-7847
AIR
COIL SPRING CONV KT [FRON
LINCOLN PASSENGER CAR 1988-94



CK-7848
AIR
COIL SPRING CONV KT [FRON
LAND ROVER SPORT UTILITY ... 1995-02



CK-7852
AIR
COIL SPRING CONVERSION K
AUDI PASSENGER CAR 2001-05



CK-7853
AIR
COIL SPRING CONVERSION K
AUDI PASSENGER CAR 2001-05



CK-7854
AIR
COIL SPRING CONV KT [FRON
AUDI PASSENGER CAR 2001-05



CK-7855WS
AIR
COIL SPRING CONV KT [FRON
BMW SPORT UTILITY 2000-06



CK-7856WS
AIR
COIL SPRING CONVERSION K
BMW SPORT UTILITY 2000-06



CK-7857
AIR
COIL SPRING CONVERSION K
BMW SPORT UTILITY 2000-06



CK-7857WS
AIR
COIL SPRING CONVERSION K
BMW SPORT UTILITY 2000-06



CK-7858
AIR
COIL SPRING CONVERSION K
BMW SPORT UTILITY 2007-14



CK-7859
AIR
COIL SPRING CONV KT [FRON
LINCOLN PASSENGER CAR 1995-96



CK-7860
AIR
COIL SPRING CONVERSION K
FORD SPORT UTILITY 2007-14
LINCOLN SPORT UTILITY 2007-14



CK-7861
AIR
COIL SPRING CONV KT [FRON
LEXUS PASSENGER CAR 1990-00

BUYER'S GUIDE

NUMERICAL LISTING - ILLUSTRATIONS

 <p style="text-align: center;">CK-7862WS AIR COIL SPRING CONV KT [FRON</p> <p>FORD SPORT UTILITY 1997-02 LINCOLN SPORT UTILITY 1998-02</p>	 <p style="text-align: center;">CK-7866 AIR COIL SPRING CONVERSION K</p> <p>LEXUS SPORT UTILITY 2003-18 TOYOTA SPORT UTILITY 2003-11</p>	 <p style="text-align: center;">CK-7870WS AIR COIL SPRING CONVERSION K</p> <p>LINCOLN PASSENGER CAR 1997-02</p>	 <p style="text-align: center;">CV-0004 (NEW) CONTROL VALVE</p> <p>AUDI PASSENGER CAR 2001-11</p>
 <p style="text-align: center;">CK-7863 AIR COIL SPRING CONVERSION K</p> <p>LEXUS PASSENGER CAR 1990-00</p>	 <p style="text-align: center;">CK-7867 AIR COIL SPRING CONV KT [FRON</p> <p>JAGUAR 2004-09</p>	<p style="text-align: center;">CK-7871 AIR COIL SPRING CONV KT [FRON</p> <p>LAND ROVER SPORT UTILITY .. 2003-05</p> <p style="text-align: center;">CK-7872 AIR COIL SPRING CONV KT [FRON</p> <p>MERCEDES-BENZ PASSENGER CAR 2002-11</p>	 <p style="text-align: center;">CV-0005 (NEW) CONTROL VALVE</p> <p>AUDI SPORTS UTILITY 2007-15 JEEP SPORT UTILITY 2011-20 PORSCHER SUV 2010-16 PORSCHER SUV 2003-16 RAM TRUCK 2013-19 TESLA 2012-15 VOLKSWAGEN SPORT UTILITY 2004-16 VOLVO SPORT UTILITY 2016-20</p>
 <p style="text-align: center;">CK-7864 AIR COIL SPRING CONVERSION K</p> <p>LEXUS PASSENGER CAR 1990-00</p>	 <p style="text-align: center;">CK-7868 AIR COIL SPRING CONV KT [FRON</p> <p>MERCEDES-BENZ PASSENGER CAR 2000-06</p>	<p style="text-align: center;">CK-7873 AIR COIL SPRING CONV KT [FRON</p> <p>AUDI SPORTS UTILITY 2007-15 PORSCHER SUV 2003-10 VOLKSWAGEN SPORT UTILITY 2004-10</p>  <p style="text-align: center;">CV-0001 (NEW) CONTROL VALVE</p> <p>BMW PASSENGER CAR 2009-17</p>	 <p style="text-align: center;">CV-0006 (NEW) CONTROL VALVE</p> <p>MERCEDES-BENZ PASSENGER CAR 2000-06</p>
 <p style="text-align: center;">CK-7865 AIR COIL SPRING CONV KT [FRON</p> <p>LAND ROVER SPORT UTILITY .. 2005-09</p>	 <p style="text-align: center;">CK-7869 (NEW) ACTIVE TO PASSIVE SUSP CONV KIT FRONT</p> <p>LEXUS SPORT UTILITY 2003-09</p>	 <p style="text-align: center;">CV-0002 (NEW) CONTROL VALVE</p> <p>BMW SPORT UTILITY 2007-14</p>	

BUYER'S GUIDE

NUMERICAL LISTING - ILLUSTRATIONS

 <p>CV-0007 (NEW) CONTROL VALVE</p> <p>MERCEDES-BENZ PASSENGER CAR 2006-17 MERCEDES-BENZ SPORT UTILITY 2003-19</p>	<p>CV-0013 (NEW) CONTROL VALVE</p> <p>JAGUAR 2010-15</p>  <p>DR-7900 DRYER</p> <p>FORD SPORT UTILITY 1997-06 LINCOLN PASSENGER CAR 1984-02 LINCOLN SPORT UTILITY 1998-06</p>	 <p>DR-7907 DRYER</p> <p>FORD VAN 1995-03 MERCURY PASSENGER CAR ... 2003-04</p>	 <p>DR-7911 DRYER</p> <p>LAND ROVER SPORT UTILITY .. 1995-02</p> <p>DR-7912 DRYER</p> <p>CADILLAC SPORT UTILITY 2002-14 CHEVROLET SPORT UTILITY ... 2000-14 GMC SPORT UTILITY 2000-14</p>
 <p>CV-0008 (NEW) CONTROL VALVE FRONT</p> <p>LAND ROVER SPORT UTILITY .. 2005-20</p>	 <p>DR-7903 DRYER</p> <p>LINCOLN PASSENGER CAR 1995-96</p>	 <p>DR-7908 DRYER</p> <p>BUICK PASSENGER CAR 1991-99 CADILLAC PASSENGER CAR 1985-96 CHEVROLET PASSENGER CAR 1995-96 OLDSMOBILE PASSENGER CAR 1987-99 PONTIAC PASSENGER CAR 1991-99</p>	 <p>DR-7914 DRYER</p> <p>LEXUS SPORT UTILITY 2003-09 TOYOTA SPORT UTILITY 2003-11</p>
 <p>CV-0009 (NEW) CONTROL VALVE RESERVOIR</p> <p>LAND ROVER SPORT UTILITY .. 2005-20</p>	 <p>DR-7906 DRYER</p> <p>FORD PASSENGER CAR 1992-11 LINCOLN PASSENGER CAR 1990-11 MERCURY PASSENGER CAR ... 1990-11</p>	 <p>DR-7909 DRYER</p> <p>BUICK PASSENGER CAR 1995-11 CADILLAC PASSENGER CAR 1993-11 OLDSMOBILE PASSENGER CAR 1995-03 PONTIAC PASSENGER CAR 2000-05</p>	 <p>DR-7915 DRYER</p> <p>LEXUS SPORT UTILITY 2010-18</p>
 <p>CV-0012 (NEW) CONTROL VALVE</p> <p>AUDI PASSENGER CAR 2012-18 BENTLEY 2011-15</p>	<p>DR-7910 DRYER</p> <p>FORD SPORT UTILITY 2007-18 LINCOLN SPORT UTILITY 2007-18</p>		

BUYER'S GUIDE

NUMERICAL LISTING - ILLUSTRATIONS



HS-8506 (NEW)
RIDE HEIGHT SENSOR

MAYBACH 2003-11
MERCEDES-BENZ
PASSENGER CAR 2000-09

HS-8507 (NEW)
RIDE HEIGHT SENSOR

MERCEDES-BENZ
PASSENGER CAR 1996-14
MERCEDES-BENZ SPORT
UTILITY 1998-12

HS-8508 (NEW)
**RIDE HEIGHT SENSOR(Front
Right)**

AUDI PASSENGER CAR 2012-18

HS-8509 (NEW)
**RIDE HEIGHT SENSOR(Front
Left)**

AUDI PASSENGER CAR 2012-18



KT-1100
**AIR SUSPENSION KIT
REAR**

FORD PASSENGER CAR 1998-11
LINCOLN PASSENGER CAR 2003-11



KT-1100A
**AIR SUSPENSION KIT
REAR**

FORD PASSENGER CAR 1992-97
LINCOLN PASSENGER CAR 1990-97
MERCURY PASSENGER CAR ... 1990-11



KT-1101
**AIR SUSPENSION KIT
REAR**

FORD SPORT UTILITY 1997-02
LINCOLN SPORT UTILITY 1998-02



KT-1102
**AIR SUSPENSION KIT
REAR**

FORD SPORT UTILITY 1997-02
LINCOLN SPORT UTILITY 1998-02



KT-1103
**AIR SUSPENSION KIT
REAR**

LINCOLN PASSENGER CAR 1993-98



KT-1104
**AIR SUSPENSION KIT
REAR**

LINCOLN PASSENGER CAR 1997-02



KT-1105
**AIR SUSPENSION KIT
REAR**

LINCOLN PASSENGER CAR 1995-96



KT-1106
**AIR SUSPENSION KIT
FRONT & REAR**

LINCOLN PASSENGER CAR 1984-92



KT-1107
**AIR SUSPENSION KIT
FRONT & REAR**

HUMMER 2003-09



KT-1108
**AIR
COIL SPRING CONVERSION KIT**

HUMMER 2003-09



KT-1109
**AIR SUSPENSION KIT
REAR**

LINCOLN PASSENGER CAR 1998-02



OR-7580
O' RING & SEAL KIT

FORD PASSENGER CAR 1992-11
FORD SPORT UTILITY 1997-06
LINCOLN PASSENGER CAR 1984-11
LINCOLN SPORT UTILITY 1998-06
MERCURY PASSENGER CAR ... 1990-11



RK-7560
RELAY KIT

CADILLAC PASSENGER CAR 1985-95

SH-1000
**SHOCK ABSORBER
REAR**

LINCOLN PASSENGER CAR 1993-98

BUYER'S GUIDE

NUMERICAL LISTING - ILLUSTRATIONS

 <p>SH-1003 (NEW) SHOCK ABSORBER REAR</p> <p>MERCEDES-BENZ PASSENGER CAR 2002-11</p>	 <p>SH-2000 STRUT FRONT</p> <p>AUDI PASSENGER CAR 2001-05</p>	 <p>SH-2005 (NEW) STRUT FRONT</p> <p>LEXUS SPORT UTILITY 2003-09</p>	 <p>SO-7592 SOLENOID REAR</p> <p>FORD TRUCK 2000-04 FORD VAN 1995-03 LINCOLN PASSENGER CAR 1993-98 LINCOLN TRUCK 2002-03</p>
 <p>SH-1004 (NEW) SHOCK ABSORBER REAR</p> <p>LAND ROVER SPORT UTILITY .. 2003-12</p>	 <p>SH-2001 STRUT REAR LEFT</p> <p>AUDI PASSENGER CAR 2001-05</p>	 <p>SO-7590 SOLENOID REAR</p> <p>FORD PASSENGER CAR 1992-11 LINCOLN PASSENGER CAR 1984-11 MERCURY PASSENGER CAR ... 1990-11</p>	 <p>SO-7593 SOLENOID FRONT</p> <p>FORD SPORT UTILITY 2003-06 SOLENOID REAR</p> <p>LINCOLN SPORT UTILITY 2003-06</p>
 <p>SH-1005 (NEW) SHOCK ABSORBER REAR LEFT</p> <p>LAND ROVER SPORT UTILITY .. 2003-12</p>	 <p>SH-2002 STRUT REAR RIGHT</p> <p>AUDI PASSENGER CAR 2001-05</p>	 <p>SO-7591 SOLENOID REAR</p> <p>FORD SPORT UTILITY 1997-02 LINCOLN PASSENGER CAR 1995-02 LINCOLN SPORT UTILITY 1998-02</p>	 <p>SO-7594 SOLENOID REAR</p> <p>FORD SPORT UTILITY 2007-14 LINCOLN SPORT UTILITY 2007-14</p>
 <p>SH-1006 (NEW) SHOCK ABSORBER REAR RIGHT</p> <p>LAND ROVER SPORT UTILITY .. 2003-12</p>	 <p>SH-2004 (NEW) STRUT FRONT</p> <p>CADILLAC SPORT UTILITY 2007-14 CHEVROLET SPORT UTILITY 2007-14 GMC SPORT UTILITY 2007-14</p>		

BUYER'S GUIDE

NUMERICAL LISTING - ILLUSTRATIONS

			<p>ST-10027 (NEW) STRUT MOUNT(Front) BMW SPORT UTILITY 2011-17</p> <p>ST-10031 (NEW) STRUT MOUNT(Front) CADILLAC SPORT UTILITY 2010-16</p> <p>ST-10037 (NEW) STRUT MOUNT(Front) TESLA 2012-19</p>
<p>ST-10000 STRUT MOUNT(Front) BMW SPORT UTILITY 2007-14</p>	<p>ST-10005 STRUT MOUNT(Front) MERCEDES-BENZ PASSENGER CAR 2006-11</p>	<p>ST-10009 STRUT MOUNT(Rear) BMW PASSENGER CAR 1999-03</p>	
			<p>ST-1901 STRUT MOUNT(Front) (bearing only) FORD PASSENGER CAR 1984-94 MERCURY PASSENGER CAR ... 1984-94</p>
<p>ST-10002 STRUT MOUNT(Front) MERCEDES-BENZ PASSENGER CAR 2003-09</p>	<p>ST-10006 STRUT MOUNT(Front) MERCEDES-BENZ PASSENGER CAR 2010-15</p>	<p>ST-10010 STRUT MOUNT(Front) (bearing only) MERCEDES-BENZ PASSENGER CAR 2008-18 MERCEDES-BENZ SPORT UTILITY 2009-18</p>	
			<p>ST-1902 STRUT MOUNT(Front) (bearing only) FORD PASSENGER CAR 1986-95 MERCURY PASSENGER CAR ... 1986-95</p>
<p>ST-10003 STRUT MOUNT(Front) AUDI PASSENGER CAR 2005-11</p>	<p>ST-10007 STRUT MOUNT(Front) MERCEDES-BENZ PASSENGER CAR 2008-15</p>	<p>ST-10011 STRUT MOUNT(Front) SMART 2008-14</p>	
			<p>ST-1903 STRUT MOUNT(Front) AUDI PASSENGER CAR 1973-79 TOYOTA TRUCK 1980-83 VOLKSWAGEN PASSENGER CAR 1974-93 VOLKSWAGEN TRUCK 1980-83</p>
<p>ST-10004 STRUT MOUNT(Front) BUICK PASSENGER CAR 2012-19 BUICK SPORT UTILITY 2013-19 CHEVROLET PASSENGER CAR 2011-16 CHEVROLET SPORT UTILITY ... 2013-19</p>	<p>ST-10008 STRUT MOUNT(Rear) AUDI PASSENGER CAR 2008-15 AUDI SPORTS UTILITY 2009-15 BMW PASSENGER CAR 1999-03 PORSCHE SUV 2015</p>	<p>ST-10012 STRUT MOUNT(Front) AUDI PASSENGER CAR 2008-15 AUDI SPORTS UTILITY 2009-15</p>	

BUYER'S GUIDE

NUMERICAL LISTING - ILLUSTRATIONS



ST-1904
STRUT MOUNT(Front)
VOLKSWAGEN PASSENGER CAR 1985-95



ST-1905
STRUT MOUNT(Front)
CHRYSLER PASSENGER CAR 1982
DODGE PASSENGER CAR 1978-90
DODGE TRUCK 1982-84
PLYMOUTH PASSENGER CAR 1978-90



ST-1906
STRUT MOUNT(Front)
CHRYSLER PASSENGER CAR 1983
DODGE PASSENGER CAR 1983
PLYMOUTH PASSENGER CAR 1983



ST-1907
STRUT MOUNT(Front)
CHRYSLER PASSENGER CAR 1984-86
DODGE PASSENGER CAR 1984-86
DODGE VAN 1984-85
PLYMOUTH PASSENGER CAR 1984-86
(Continued Next Column)

ST-1907 (Continued)
PLYMOUTH VAN 1984-85



ST-1908
STRUT MOUNT(Front)
CHRYSLER PASSENGER CAR 1986-95
CHRYSLER VAN 1990-95
DODGE PASSENGER CAR 1986-95
DODGE VAN 1986-95
PLYMOUTH PASSENGER CAR 1986-95
PLYMOUTH VAN 1986-95



ST-1909
STRUT MOUNT(Front) (RIGHT)
TOYOTA PASSENGER CAR 1982-87



ST-1910
STRUT MOUNT(Front) (LEFT)
TOYOTA PASSENGER CAR 1982-87

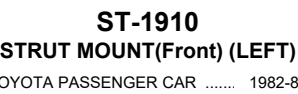

ST-1911
STRUT MOUNT(Front) (RIGHT)
TOYOTA PASSENGER CAR 1984-87



ST-1912
STRUT MOUNT(Front) (LEFT)
TOYOTA PASSENGER CAR 1984-87



ST-1913
STRUT MOUNT(Front)
BUICK PASSENGER CAR 1982-91
CADILLAC PASSENGER CAR 1982-88
CHEVROLET PASSENGER CAR 1982-91
OLDSMOBILE PASSENGER CAR 1982-91
PONTIAC PASSENGER CAR 1982-91



ST-1916
STRUT MOUNT(Front)
FORD PASSENGER CAR 1981-85
MERCURY PASSENGER CAR 1983-85



ST-1921
STRUT MOUNT(Front)
BUICK PASSENGER CAR 1988-96
CHEVROLET PASSENGER CAR 1990-01
OLDSMOBILE PASSENGER CAR 1988-97
PONTIAC PASSENGER CAR 1988-96



ST-1922
STRUT MOUNT(Front)
BUICK PASSENGER CAR 1990-99
CADILLAC PASSENGER CAR 1991-93
OLDSMOBILE PASSENGER CAR 1990-99
PONTIAC PASSENGER CAR 1990-99



ST-1923
STRUT MOUNT(Front) (RIGHT)
CHEVROLET PASSENGER CAR 1982-92
PONTIAC PASSENGER CAR 1982-92



ST-1921 (Continued)
STRUT MOUNT(Front)
BUICK PASSENGER CAR 1988-96
CHEVROLET PASSENGER CAR 1990-01
OLDSMOBILE PASSENGER CAR 1988-97
PONTIAC PASSENGER CAR 1988-96



ST-1922 (Continued)
STRUT MOUNT(Front)
BUICK PASSENGER CAR 1990-99
CADILLAC PASSENGER CAR 1991-93
OLDSMOBILE PASSENGER CAR 1990-99
PONTIAC PASSENGER CAR 1990-99



ST-1923 (Continued)
STRUT MOUNT(Front) (RIGHT)
CHEVROLET PASSENGER CAR 1982-92
PONTIAC PASSENGER CAR 1982-92

BUYER'S GUIDE

NUMERICAL LISTING - ILLUSTRATIONS



ST-1924
STRUT MOUNT(Front) (LEFT)

CHEVROLET PASSENGER CAR 1982-92
PONTIAC PASSENGER CAR 1982-92



ST-1925
STRUT MOUNT(Front)

FORD PASSENGER CAR 1978-04
MERCURY PASSENGER CAR 1978-86



ST-1926
STRUT MOUNT(Front)

FORD PASSENGER CAR 1986-95
LINCOLN PASSENGER CAR 1988-94
MERCURY PASSENGER CAR 1986-95



ST-1927
STRUT MOUNT(Front)

FORD PASSENGER CAR 1984-94
MERCURY PASSENGER CAR 1984-94



ST-1928
STRUT MOUNT(Front) (bearing only)

BUICK PASSENGER CAR 1985-96
CADILLAC PASSENGER CAR 1987-02
OLDSMOBILE PASSENGER CAR 1985-99
PONTIAC PASSENGER CAR 1987-99

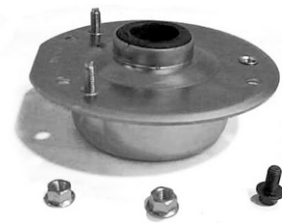

ST-1929
STRUT MOUNT(Front)

CHEVROLET PASSENGER CAR 1987-94
PONTIAC PASSENGER CAR 1987-94



ST-1930
STRUT MOUNT(Front)

MAZDA PASSENGER CAR 1981-89
MERCURY PASSENGER CAR 1987-89



ST-1932
STRUT MOUNT(Front)

CHEVROLET PASSENGER CAR 1985-88
GEO PASSENGER CAR 1989
ISUZU PASSENGER CAR 1985-89
PONTIAC PASSENGER CAR 1985-88



ST-1933
STRUT MOUNT(Front)

HONDA PASSENGER CAR 1982-85

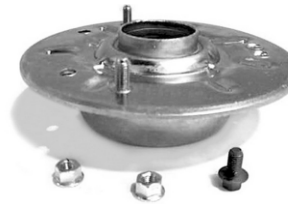

ST-1934
STRUT MOUNT(Front)

BUICK PASSENGER CAR 1982-96
CHEVROLET PASSENGER CAR 1982-90
CHEVROLET VAN 1990-96
OLDSMOBILE PASSENGER CAR 1982-96
OLDSMOBILE VAN 1990-96
PONTIAC PASSENGER CAR 1982-91
PONTIAC VAN 1990-96



ST-1937
STRUT MOUNT(Front)

DODGE PASSENGER CAR 1977-84
HYUNDAI PASSENGER CAR 1986-89
MITSUBISHI PASSENGER CAR 1987-88
PLYMOUTH PASSENGER CAR 1976-84



ST-1938
STRUT MOUNT(Front)

HYUNDAI PASSENGER CAR 1990-95
MITSUBISHI PASSENGER CAR 1989-94



ST-1939
STRUT MOUNT(Front)

ACURA PASSENGER CAR 1986-89
HONDA PASSENGER CAR 1984-87

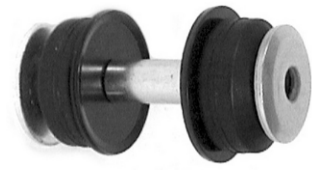

ST-1940
STRUT MOUNT(Front)

ACURA PASSENGER CAR 1986-14
CHRYSLER PASSENGER CAR 1995-06
DODGE PASSENGER CAR 1995-06
HONDA PASSENGER CAR 1983-08
HONDA SPORT UTILITY 1997-01
HONDA VAN 1995-98
ISUZU VAN 1996-99
PLYMOUTH PASSENGER CAR 1996-00

STRUT MOUNT(Rear)

ACURA PASSENGER CAR 1990-14
CHRYSLER PASSENGER CAR 2001-06

STRUT MOUNT(Rear) (Bushing)

DODGE PASSENGER CAR 2001-06

STRUT MOUNT(Rear)

HONDA PASSENGER CAR 1988-08
HONDA SPORT UTILITY 1997-14
HONDA VAN 1995-98

(Continued Next Page)

BUYER'S GUIDE

NUMERICAL LISTING - ILLUSTRATIONS

ST-1940 (Continued)

ISUZU VAN 1996-99



ST-1941 STRUT MOUNT(Front)

VOLKSWAGEN PASSENGER
CAR 1973-93



ST-1942 STRUT MOUNT(Front)

AUDI PASSENGER CAR 1980-88
VOLKSWAGEN PASSENGER
CAR 1982-88



ST-1943 STRUT MOUNT(Front)

CHEVROLET PASSENGER
CAR 1985-88
TOYOTA PASSENGER CAR 1983-88



ST-1944 STRUT MOUNT(Front)

LEXUS PASSENGER CAR 1990-91
TOYOTA PASSENGER CAR 1987-91
TOYOTA VAN 1991-97



ST-1946 STRUT MOUNT(Front)

BUICK PASSENGER CAR 1992-94
CHEVROLET PASSENGER
CAR 1992-94
OLDSMOBILE PASSENGER
CAR 1992-94
PONTIAC PASSENGER CAR 1992-94



ST-1947 STRUT MOUNT(Front) (bearing only)

INFINITI PASSENGER CAR 1990-92
NISSAN PASSENGER CAR 1970-94



ST-1948 STRUT MOUNT(Front) (LEFT) STRUT MOUNT(Front)

NISSAN PASSENGER CAR 1985-89
TOYOTA PASSENGER CAR 1978-82



ST-1950 STRUT MOUNT(Front)

SATURN PASSENGER CAR 1991-02



ST-1951 STRUT MOUNT(Rear)

BUICK PASSENGER CAR 1984-98
CADILLAC PASSENGER CAR 1984-88
CHEVROLET PASSENGER
CAR 1984-96
CHEVROLET VAN 1990-96
OLDSMOBILE PASSENGER
CAR 1984-98
OLDSMOBILE VAN 1990-96
PONTIAC PASSENGER CAR 1984-98
PONTIAC VAN 1990-96



ST-1952 STRUT MOUNT(Rear)

DODGE PASSENGER CAR 1978-90
PLYMOUTH PASSENGER
CAR 1978-90



ST-1953 STRUT MOUNT(Rear)

BUICK PASSENGER CAR 1985-99
CADILLAC PASSENGER CAR 1985-93
OLDSMOBILE PASSENGER
CAR 1985-99
PONTIAC PASSENGER CAR 1987-99



ST-1954 STRUT MOUNT(Rear)

FORD PASSENGER CAR 1986-07
MERCURY PASSENGER CAR 1986-05



ST-1955 STRUT MOUNT(Rear)

FORD PASSENGER CAR 1984-94
MERCURY PASSENGER CAR 1984-94



ST-1956 STRUT MOUNT(Rear)

FORD PASSENGER CAR 1981-90
MERCURY PASSENGER CAR 1981-87

BUYER'S GUIDE

NUMERICAL LISTING - ILLUSTRATIONS

 <p>ST-1958 STRUT MOUNT(Rear)</p> <p>CHEVROLET PASSENGER CAR 1985-88 TOYOTA PASSENGER CAR 1983-91</p>	 <p>ST-1962 STRUT MOUNT(Rear)</p> <p>LEXUS PASSENGER CAR 1990-91 TOYOTA PASSENGER CAR 1987-91</p>	 <p>ST-1966 STRUT MOUNT(Rear)</p> <p>VOLKSWAGEN PASSENGER CAR 1975-02</p>	 <p>ST-1970 STRUT MOUNT(Front)</p> <p>FORD PASSENGER CAR 1989-97 MERCURY PASSENGER CAR ... 1989-97</p>
 <p>ST-1959 STRUT MOUNT(Rear)</p> <p>MAZDA PASSENGER CAR 1981-89 MERCURY PASSENGER CAR ... 1987-93</p>	 <p>ST-1963 STRUT MOUNT(Rear)</p> <p>FORD PASSENGER CAR 1991-03 MAZDA PASSENGER CAR 1990-95 MERCURY PASSENGER CAR ... 1991-99</p>	 <p>ST-1967 STRUT MOUNT(Front)</p> <p>TOYOTA PASSENGER CAR 1983-88</p>	 <p>ST-1971 STRUT MOUNT(Front)</p> <p>FORD PASSENGER CAR 1980-86 LINCOLN PASSENGER CAR 1982-92 MERCURY PASSENGER CAR ... 1980-86</p>
 <p>ST-1960 STRUT MOUNT(Rear)</p> <p>FORD PASSENGER CAR 1989-92 MAZDA PASSENGER CAR 1988-92</p>	 <p>ST-1964 STRUT MOUNT(Rear)</p> <p>SATURN PASSENGER CAR 1991-02</p>	 <p>ST-1968 STRUT MOUNT(Front)</p> <p>TOYOTA PASSENGER CAR 1970-84</p>	 <p>ST-1973 STRUT MOUNT(Front)</p> <p>BUICK PASSENGER CAR 1985-90 CADILLAC PASSENGER CAR ... 1987-90 OLDSMOBILE PASSENGER CAR 1985-90 PONTIAC PASSENGER CAR 1987-90</p>
 <p>ST-1961 STRUT MOUNT(Rear)</p> <p>ACURA PASSENGER CAR 1986-03 HONDA PASSENGER CAR 1979-07</p>	 <p>ST-1965 STRUT MOUNT(Rear)</p> <p>BMW PASSENGER CAR 1984-02</p>	 <p>ST-1969 STRUT MOUNT(Front)</p> <p>TOYOTA PASSENGER CAR 1987-90</p>	 <p>ST-1974 STRUT MOUNT(Front)</p> <p>FORD PASSENGER CAR 1987-88 MERCURY PASSENGER CAR ... 1987-88</p>

BUYER'S GUIDE

NUMERICAL LISTING - ILLUSTRATIONS



ST-1975
STRUT MOUNT(Front) (LEFT)
 NISSAN PASSENGER CAR 1990-99



ST-1976
STRUT MOUNT(Front)
 HYUNDAI PASSENGER CAR 1989-94
 MITSUBISHI VAN 1992-95
 PLYMOUTH PASSENGER
 CAR 1992-94



ST-1977
STRUT MOUNT(Front)
 DODGE PASSENGER CAR 1989-92
 EAGLE PASSENGER CAR 1989-92
 HYUNDAI PASSENGER CAR 1992-95
 MITSUBISHI PASSENGER
 CAR 1989-92
 PLYMOUTH PASSENGER
 CAR 1989-92

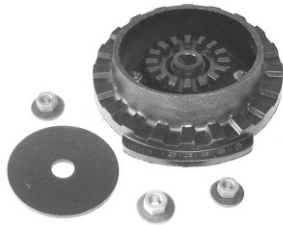

ST-1978
STRUT MOUNT(Rear)
 CHRYSLER PASSENGER
 CAR 1993-97
 DODGE PASSENGER CAR 1993-97
 EAGLE PASSENGER CAR 1993-97



ST-1979
STRUT MOUNT(Front)
 TOYOTA PASSENGER CAR 1986-93



ST-1980
STRUT MOUNT(Front)
 CHRYSLER PASSENGER
 CAR 1993-97
 DODGE PASSENGER CAR 1993-97
 EAGLE PASSENGER CAR 1993-97



ST-1981
STRUT MOUNT(Front)
 VOLVO PASSENGER CAR 1975-93

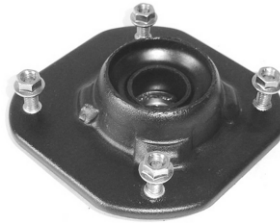

ST-1983
STRUT MOUNT(Front)
 TOYOTA PASSENGER CAR 1995-99



ST-1984
STRUT MOUNT(Rear)
 TOYOTA PASSENGER CAR 1987-95



ST-1985
STRUT MOUNT(Front)
 AUDI PASSENGER CAR 1980-94



ST-1986

ST-1986
STRUT MOUNT(Front) (bearing only)
 OLDSMOBILE PASSENGER
 CAR 1988-97



ST-1987
STRUT MOUNT(Front)
 CHEVROLET PASSENGER
 CAR 1989-01
 GEO PASSENGER CAR 1989-97
 PONTIAC PASSENGER CAR 1989-00
 SUZUKI PASSENGER CAR 1989-01



ST-1988
STRUT MOUNT(Rear)
 CHEVROLET PASSENGER
 CAR 1989-01
 GEO PASSENGER CAR 1989-97
 PONTIAC PASSENGER CAR 1989-91
 SUZUKI PASSENGER CAR 1989-01

BUYER'S GUIDE

NUMERICAL LISTING - ILLUSTRATIONS

 <p style="text-align: center;">ST-1989 STRUT MOUNT(Rear)</p> <p>NISSAN PASSENGER CAR 1991-95</p>	 <p style="text-align: center;">ST-1993 STRUT MOUNT(Front)</p> <p>TOYOTA PASSENGER CAR 1975-85</p>	 <p style="text-align: center;">ST-1999 STRUT MOUNT(Front)</p> <p>FORD PASSENGER CAR 1989-92 MAZDA PASSENGER CAR 1988-92</p>	 <p style="text-align: center;">ST-2903 STRUT MOUNT(Front)</p> <p>BMW PASSENGER CAR 1977-83</p>
 <p style="text-align: center;">ST-1990 STRUT MOUNT(Front)</p> <p>BUICK PASSENGER CAR 1986-89 CADILLAC PASSENGER CAR 1986 OLDSMOBILE PASSENGER CAR 1986-89</p>	 <p style="text-align: center;">ST-1994 STRUT MOUNT(Front)</p> <p>CHEVROLET SPORT UTILITY 1989-98 GEO SPORT UTILITY 1989-97 GMC SPORT UTILITY 1989-91 PONTIAC PASSENGER CAR 1994-97 SUZUKI SPORT UTILITY 1989-98</p>	 <p style="text-align: center;">ST-2901 STRUT MOUNT(Rear)</p> <p>CHEVROLET PASSENGER CAR 1998-02 GEO PASSENGER CAR 1989-97 TOYOTA PASSENGER CAR 1988-02</p>	 <p style="text-align: center;">ST-2904 STRUT MOUNT(Front)</p> <p>BMW PASSENGER CAR 1982-95</p>
 <p style="text-align: center;">ST-1991 STRUT MOUNT(Front)</p> <p>CADILLAC PASSENGER CAR 1985-86</p>	 <p style="text-align: center;">ST-1995 STRUT MOUNT(Front)</p> <p>PONTIAC PASSENGER CAR 1988-93</p>	 <p style="text-align: center;">ST-2902 STRUT MOUNT(Front)</p> <p>MERCEDES-BENZ PASSENGER CAR 1984-96</p>	 <p style="text-align: center;">ST-2905 STRUT MOUNT(Front)</p> <p>BMW PASSENGER CAR 1991-02</p>
 <p style="text-align: center;">ST-1992 STRUT MOUNT(Front)</p> <p>DODGE PASSENGER CAR 1971-80 PLYMOUTH PASSENGER CAR 1976-84</p>	 <p style="text-align: center;">ST-1996 STRUT MOUNT(Front)</p> <p>TOYOTA PASSENGER CAR 1974-79</p>	 <p style="text-align: center;">ST-2906 STRUT MOUNT(Front)</p> <p>VOLKSWAGEN PASSENGER CAR 1992-02</p>	

BUYER'S GUIDE

NUMERICAL LISTING - ILLUSTRATIONS



ST-2907
STRUT MOUNT(Front)

DODGE PASSENGER CAR 1995-99
PLYMOUTH PASSENGER
CAR 1995-99



ST-2911
STRUT MOUNT(Front)

VOLVO PASSENGER CAR 1983-98



ST-2915
STRUT MOUNT(Front)

HYUNDAI PASSENGER CAR 1995-99



ST-2919
STRUT MOUNT(Front)
STRUT MOUNT(Rear)

MAZDA PASSENGER CAR 1990-97
MAZDA PASSENGER CAR 1990-97



ST-2908
STRUT MOUNT(Rear)

DODGE PASSENGER CAR 1995-99
PLYMOUTH PASSENGER
CAR 1995-99



ST-2912
STRUT MOUNT(Front)

TOYOTA PASSENGER CAR 1985-92



ST-2916
STRUT MOUNT(Rear)

PONTIAC PASSENGER CAR 1984-88



ST-2920
STRUT MOUNT(Front)

EAGLE PASSENGER CAR 1990-94
MITSUBISHI PASSENGER
CAR 1990-94
PLYMOUTH PASSENGER
CAR 1990-94



ST-2909
STRUT MOUNT(Front)

RENAULT PASSENGER CAR 1983-87



ST-2913
STRUT MOUNT(Front)

SUBARU PASSENGER CAR 1985-94



ST-2917
STRUT MOUNT(Front)

DODGE PASSENGER CAR 1985-86
MITSUBISHI PASSENGER
CAR 1985-86
PLYMOUTH PASSENGER
CAR 1985-86



ST-2921
STRUT MOUNT(Front)

MAZDA VAN 1989-98



ST-2910
STRUT MOUNT(Front)

FORD VAN 1995-03



ST-2914
STRUT MOUNT(Front)

HYUNDAI PASSENGER CAR 1995-98
MITSUBISHI PASSENGER
CAR 1992-03



ST-2918
STRUT MOUNT(Front)

DODGE PASSENGER CAR 1987-90
EAGLE PASSENGER CAR 1989-92
MITSUBISHI PASSENGER
CAR 1987-88
PLYMOUTH PASSENGER
CAR 1987-90



ST-2922
STRUT MOUNT(Front) (LEFT)
STRUT MOUNT(Front)

FORD PASSENGER CAR 1993-97
KIA PASSENGER CAR 1998-01

(Continued Next Page)

BUYER'S GUIDE

NUMERICAL LISTING - ILLUSTRATIONS

ST-2922 (Continued)

STRUT MOUNT(Front) (LEFT)

MAZDA PASSENGER CAR 1993-97



ST-2923 STRUT MOUNT(Front)

CHRYSLER PASSENGER CAR 1995-00
 DODGE PASSENGER CAR 1995-00
 EAGLE PASSENGER CAR 1995-98
 HYUNDAI PASSENGER CAR 1999-05
 KIA PASSENGER CAR 2001-06
 MITSUBISHI PASSENGER CAR 1994-99

STRUT MOUNT(Rear)

CHRYSLER PASSENGER CAR 1995-05
 DODGE PASSENGER CAR 1989-05
 EAGLE PASSENGER CAR 1989-98
 HYUNDAI PASSENGER CAR 1992-05
 MITSUBISHI PASSENGER CAR 1985-05
 MITSUBISHI VAN 1992-95
 PLYMOUTH PASSENGER CAR 1990-94



ST-2924 STRUT MOUNT(Front)

SUBARU PASSENGER CAR 1990-14
 SUBARU SPORT UTILITY 1998-14



ST-2925 STRUT MOUNT(Front)

AUDI PASSENGER CAR 1978-79



ST-2926 STRUT MOUNT(Front)

LEXUS PASSENGER CAR 1992-94
 TOYOTA PASSENGER CAR 1992-94

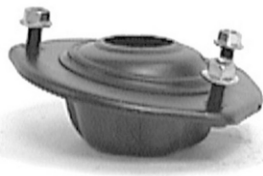

ST-2927 STRUT MOUNT(Rear)

TOYOTA PASSENGER CAR 1992-96



ST-2928 STRUT MOUNT(Front)

ACURA PASSENGER CAR 1991-95



ST-2929 STRUT MOUNT(Front)

DODGE PASSENGER CAR 1990-92
 EAGLE PASSENGER CAR 1988-92



ST-2930 STRUT MOUNT(Front)

BUICK PASSENGER CAR 1995-97
 OLDSMOBILE PASSENGER CAR 1995-97



ST-2931 STRUT MOUNT(Front)

SUBARU PASSENGER CAR 1980-89
 SUBARU SPORT UTILITY 1983-87



ST-2932 STRUT MOUNT(Front)

GEO PASSENGER CAR 1990-93
 ISUZU PASSENGER CAR 1990-93



ST-2933 STRUT MOUNT(Front)

CHEVROLET PASSENGER CAR 1985-88
 PONTIAC PASSENGER CAR 1985-88

(Continued Next Column)

ST-2933 (Continued)

SUZUKI TRUCK 1985-88



ST-2934 STRUT MOUNT(Front)

MAZDA PASSENGER CAR 1979-85



ST-2935 STRUT MOUNT(Front)

FORD PASSENGER CAR 1989-92
 MAZDA PASSENGER CAR 1988-92



ST-2936 STRUT MOUNT(Front)

FORD PASSENGER CAR 1991-96
 MAZDA PASSENGER CAR 1990-95
 MERCURY PASSENGER CAR 1991-96

BUYER'S GUIDE

NUMERICAL LISTING - ILLUSTRATIONS



ST-2937

STRUT MOUNT(Front)

NISSAN PASSENGER CAR 1983-92

STRUT MOUNT(Rear)

NISSAN PASSENGER CAR 1987-92



ST-2941

STRUT MOUNT(Rear)

BUICK PASSENGER CAR 1988-96

CHEVROLET PASSENGER CAR 1995-00

1990-94

OLDSMOBILE PASSENGER CAR 1988-97

PONTIAC PASSENGER CAR 1988-96



ST-2945

STRUT MOUNT(Front)

CHRYSLER VAN 1995-00

DODGE VAN 1995-00

PLYMOUTH VAN 1995-00

ST-2948 (Continued)

PONTIAC PASSENGER CAR 1993-02



ST-2949

STRUT MOUNT(Rear)

CHEVROLET PASSENGER CAR 1995-05

PONTIAC PASSENGER CAR 1995-05



ST-2938

STRUT MOUNT(Front)

NISSAN PASSENGER CAR 1991-99



ST-2942

STRUT MOUNT(Rear) (RIGHT)

MAZDA PASSENGER CAR 1983-85



ST-2946

STRUT MOUNT(Rear)

CHRYSLER PASSENGER CAR 1995-00

DODGE PASSENGER CAR 1995-00

PLYMOUTH PASSENGER CAR 1996-00



ST-2950

STRUT MOUNT(Rear)

HONDA PASSENGER CAR 1988-91



ST-2939

STRUT MOUNT(Front) (LEFT)

MAZDA PASSENGER CAR 1983-87



ST-2943

STRUT MOUNT(Rear) (LEFT)

MAZDA PASSENGER CAR 1983-85



ST-2947

STRUT MOUNT(Front) (LEFT)

CHEVROLET PASSENGER CAR 1993-02

PONTIAC PASSENGER CAR 1993-02



ST-2951

STRUT MOUNT(Rear) (RIGHT)

FORD PASSENGER CAR 1993-97

MAZDA PASSENGER CAR 1993-99



ST-2940

STRUT MOUNT(Front)

FORD PASSENGER CAR 1988-97



ST-2944

STRUT MOUNT(Front)

FORD PASSENGER CAR 1996-07

MERCURY PASSENGER CAR 1996-05



ST-2948

STRUT MOUNT(Front) (RIGHT)

CHEVROLET PASSENGER CAR 1993-02

(Continued Next Column)

BUYER'S GUIDE

NUMERICAL LISTING - ILLUSTRATIONS

 <p style="text-align: center;">ST-2952 STRUT MOUNT(Rear) (LEFT)</p> <p>FORD PASSENGER CAR 1993-97 MAZDA PASSENGER CAR 1993-99</p>	 <p style="text-align: center;">ST-2956 STRUT MOUNT(Rear)</p> <p>BMW PASSENGER CAR 1986-94</p>	 <p style="text-align: center;">ST-2960 STRUT MOUNT(Front)</p> <p>MAZDA PASSENGER CAR 1988-89</p>	 <p style="text-align: center;">ST-2963 STRUT MOUNT(Front)</p> <p>DODGE PASSENGER CAR 1981-83 PLYMOUTH PASSENGER CAR 1981-83</p>
 <p style="text-align: center;">ST-2953 STRUT MOUNT(Front)</p> <p>FORD PASSENGER CAR 1995-00 MERCURY PASSENGER CAR ... 1995-02</p>	 <p style="text-align: center;">ST-2957 STRUT MOUNT(Rear)</p> <p>TOYOTA PASSENGER CAR 1990-99</p>	 <p style="text-align: center;">ST-2961 STRUT MOUNT(Front)</p> <p>CHRYSLER PASSENGER CAR 1987-89 DODGE PASSENGER CAR 1984-86 MITSUBISHI PASSENGER CAR 1983-89 PLYMOUTH PASSENGER CAR 1984-86</p>	 <p style="text-align: center;">ST-2964 STRUT MOUNT(Rear)</p> <p>HYUNDAI PASSENGER CAR 1989-98</p>
 <p style="text-align: center;">ST-2954 STRUT MOUNT(Rear)</p> <p>FORD PASSENGER CAR 1995-00 MERCURY PASSENGER CAR ... 1995-00</p>	 <p style="text-align: center;">ST-2958 STRUT MOUNT(Front)</p> <p>DODGE PASSENGER CAR 1993-95 EAGLE PASSENGER CAR 1993-96 MITSUBISHI PASSENGER CAR 1993-96 PLYMOUTH PASSENGER CAR 1993-94</p>	 <p style="text-align: center;">ST-2962 STRUT MOUNT(Rear)</p> <p>CHRYSLER PASSENGER CAR 1987-89 DODGE PASSENGER CAR 1984-86 MITSUBISHI PASSENGER CAR 1983-89 PLYMOUTH PASSENGER CAR 1984-86</p>	 <p style="text-align: center;">ST-2965 STRUT MOUNT(Front)</p> <p>BUICK PASSENGER CAR 1990-93 CADILLAC PASSENGER CAR ... 1987-02 OLDSMOBILE PASSENGER CAR 1990-92</p>
 <p style="text-align: center;">ST-2955 STRUT MOUNT(Front)</p> <p>DODGE PASSENGER CAR 1991-96 MITSUBISHI PASSENGER CAR 1991-99</p>	 <p style="text-align: center;">ST-2959 STRUT MOUNT(Rear)</p> <p>GEO PASSENGER CAR 1990-93 ISUZU PASSENGER CAR 1990-93</p>	 <p style="text-align: center;">ST-2966 STRUT MOUNT(Rear)</p> <p>MAZDA PASSENGER CAR 1988-91</p>	

BUYER'S GUIDE

NUMERICAL LISTING - ILLUSTRATIONS



ST-2967
STRUT MOUNT(Rear)

ACURA PASSENGER CAR 1986-88



ST-2968
STRUT MOUNT(Rear) (RIGHT)

BUICK PASSENGER CAR 1997-09
 CHEVROLET PASSENGER CAR 1995-14
 OLDSMOBILE PASSENGER CAR 1998-02
 PONTIAC PASSENGER CAR 1997-08



ST-2969
STRUT MOUNT(Rear) (LEFT)

BUICK PASSENGER CAR 1997-09
 CHEVROLET PASSENGER CAR 1995-14
 OLDSMOBILE PASSENGER CAR 1998-02
 PONTIAC PASSENGER CAR 1997-08



ST-2970
STRUT MOUNT(Front)

MAZDA PASSENGER CAR 1999-05

STRUT MOUNT(Rear)

FORD PASSENGER CAR 1988-97
 MAZDA PASSENGER CAR 1999-05



ST-2971
STRUT MOUNT(Rear)

BUICK PASSENGER CAR 1986-93
 CADILLAC PASSENGER CAR 1986-93
 OLDSMOBILE PASSENGER CAR 1986-92



ST-2972
STRUT MOUNT(Front)

BUICK PASSENGER CAR 1998-05
 CADILLAC PASSENGER CAR 1998-05
 OLDSMOBILE PASSENGER CAR 1998-03
 PONTIAC PASSENGER CAR 2000-05



ST-2973
STRUT MOUNT(Front) (RIGHT)

BUICK PASSENGER CAR 1997-09

STRUT MOUNT(Front)

BUICK SPORT UTILITY 2002-07
 BUICK VAN 2005-07

STRUT MOUNT(Front) (LEFT)

CHEVROLET PASSENGER CAR 2000-13

STRUT MOUNT(Front)

CHEVROLET VAN 1997-09

STRUT MOUNT(Front) (LEFT)

OLDSMOBILE PASSENGER CAR 1998-02

STRUT MOUNT(Front)

OLDSMOBILE VAN 1997-04

STRUT MOUNT(Front) (LEFT)

PONTIAC PASSENGER CAR 1997-08

STRUT MOUNT(Front)

PONTIAC SPORT UTILITY 2001-05
 PONTIAC VAN 1997-09
 SATURN VAN 2005-07



ST-2974
STRUT MOUNT(Front)

MAZDA PASSENGER CAR 1986-91



ST-2975
STRUT MOUNT(Rear)

MAZDA PASSENGER CAR 1986-91



ST-2976
STRUT MOUNT(Front)

MERCURY PASSENGER CAR ... 1991-93



ST-2977
STRUT MOUNT(Front)

MITSUBISHI PASSENGER CAR 1985-93



ST-2978
STRUT MOUNT(Rear)

NISSAN PASSENGER CAR 1990-99



ST-2979
STRUT MOUNT(Front)

NISSAN PASSENGER CAR 1989-98

BUYER'S GUIDE

NUMERICAL LISTING - ILLUSTRATIONS

 <p>ST-2980 STRUT MOUNT(Rear) NISSAN PASSENGER CAR 1989-98</p>	 <p>ST-2984 STRUT MOUNT(Front) (LEFT) HYUNDAI PASSENGER CAR 1996-06 STRUT MOUNT(Front) KIA PASSENGER CAR 2004-09</p>	 <p>ST-2988 STRUT MOUNT(Rear) TOYOTA PASSENGER CAR 1989-92</p>	 <p>ST-2991 STRUT MOUNT(Rear) ACURA PASSENGER CAR 1991-95</p>
 <p>ST-2981 STRUT MOUNT(Rear) NISSAN PASSENGER CAR 1993-01</p>	 <p>ST-2985 STRUT MOUNT(Front) NISSAN PASSENGER CAR 1990-96</p>	 <p>ST-2989 STRUT MOUNT(Front) MERCURY VAN 1993-02 STRUT MOUNT(Front) (LEFT) NISSAN PASSENGER CAR 1989-94 STRUT MOUNT(Front) (RIGHT) NISSAN VAN 1990-02</p>	 <p>ST-2992 STRUT MOUNT(Front) CHEVROLET SPORT UTILITY 1988-99 CHEVROLET TRUCK 1988-99 GMC SPORT UTILITY 1988-99 GMC TRUCK 1991-99 OLDSMOBILE SPORT UTILITY .. 1991-99</p>
 <p>ST-2982 STRUT MOUNT(Rear) (LEFT) NISSAN PASSENGER CAR 1985-94 NISSAN VAN 1990-94</p>	 <p>ST-2986 STRUT MOUNT(Rear) TOYOTA PASSENGER CAR 1995-99</p>	 <p>ST-2990 STRUT MOUNT(Rear) VOLKSWAGEN PASSENGER CAR 1990-97</p>	 <p>ST-2993 STRUT MOUNT(Front) (UPPER SPR SEAT) DODGE VAN 1986-94</p>
 <p>ST-2983 STRUT MOUNT(Rear) (RIGHT) NISSAN PASSENGER CAR 1985-94 NISSAN VAN 1990-94</p>	 <p>ST-2987 STRUT MOUNT(Front) SAAB PASSENGER CAR 1986-98</p>	 <p>ST-2994 STRUT MOUNT(Front) (LOWER SPR SEAT & BEAR LEFT)</p>	

(Continued Next Page)

BUYER'S GUIDE

NUMERICAL LISTING - ILLUSTRATIONS

ST-2994 (Continued)

BUICK PASSENGER CAR	1988-96
CHEVROLET PASSENGER CAR	1990-01
OLDSMOBILE PASSENGER CAR	1988-97
PONTIAC PASSENGER CAR	1988-96



ST-2995 STRUT MOUNT(Front) (LOWER SPR SEAT & BEAR RIGHT)

BUICK PASSENGER CAR	1988-96
CHEVROLET PASSENGER CAR	1990-01
OLDSMOBILE PASSENGER CAR	1988-97
PONTIAC PASSENGER CAR	1988-96



ST-2997 STRUT MOUNT(Rear)

LINCOLN PASSENGER CAR	1988-94
-----------------------------	---------



ST-2998 STRUT MOUNT(Rear)

BUICK PASSENGER CAR	1995-11
CADILLAC PASSENGER CAR	1998-11
OLDSMOBILE PASSENGER CAR	1995-03
PONTIAC PASSENGER CAR	2000-05



ST-2999 STRUT MOUNT(Front)

CHEVROLET PASSENGER CAR	1997-05
OLDSMOBILE PASSENGER CAR	1997-04
PONTIAC PASSENGER CAR	1999-05



ST-3000 STRUT MOUNT(Rear)

CHEVROLET PASSENGER CAR	1997-05
OLDSMOBILE PASSENGER CAR	1997-04
PONTIAC PASSENGER CAR	1999-05



ST-3001 STRUT MOUNT(Front)

CHRYSLER PASSENGER CAR	1998-04
DODGE PASSENGER CAR	1998-04



ST-3002 STRUT MOUNT(Rear)

CHRYSLER PASSENGER CAR	1998-04
------------------------------	---------

(Continued Next Column)

ST-3902 (Continued)

DODGE PASSENGER CAR	1998-04
---------------------------	---------



ST-3903 STRUT MOUNT(Front) (RIGHT)

LEXUS PASSENGER CAR	1997-03
LEXUS SPORT UTILITY	1999-03
TOYOTA PASSENGER CAR	1997-04
TOYOTA VAN	1998-03



ST-3904 STRUT MOUNT(Rear) (LEFT)

LEXUS PASSENGER CAR	1997-06
LEXUS SPORT UTILITY	1999-03

ST-3905 STRUT MOUNT(Rear) (LEFT)

TOYOTA PASSENGER CAR	1997-06
TOYOTA SPORT UTILITY	2001-03



ST-3905 STRUT MOUNT(Front) (UPPER SPR SEAT)

FORD PASSENGER CAR	1989-92
MAZDA PASSENGER CAR	1988-92



ST-3906 STRUT MOUNT(Front) (LEFT)

LEXUS PASSENGER CAR	1997-03
LEXUS SPORT UTILITY	1999-03
TOYOTA PASSENGER CAR	1997-04
TOYOTA VAN	1998-03



ST-3907 STRUT MOUNT(Front) (LEFT)

MAZDA PASSENGER CAR	1995-98
---------------------------	---------



ST-3908 STRUT MOUNT(Rear)

MAZDA PASSENGER CAR	1995-98
---------------------------	---------



ST-3909 STRUT MOUNT(Rear) (LEFT)

MAZDA PASSENGER CAR	1995-98
---------------------------	---------

BUYER'S GUIDE

NUMERICAL LISTING - ILLUSTRATIONS

 <p>ST-3910</p> <p>ST-3910 STRUT MOUNT(Front)</p> <p>INFINITI PASSENGER CAR 1993-99 NISSAN PASSENGER CAR 1995-99</p>	 <p>ST-3914</p> <p>ST-3914 STRUT MOUNT(Front)</p> <p>BMW SPORT UTILITY 2000-06</p>	 <p>ST-3918</p> <p>ST-3918 STRUT MOUNT(Front)</p> <p>BMW PASSENGER CAR 1996-13 BMW SPORT UTILITY 2004-10</p>	 <p>ST-3922</p> <p>ST-3922 STRUT MOUNT(Front)</p> <p>BMW PASSENGER CAR 1993-01</p>
 <p>ST-3911</p> <p>ST-3911 STRUT MOUNT(Front) STRUT MOUNT(Rear)</p> <p>INFINITI PASSENGER CAR 1991-02 INFINITI PASSENGER CAR 1990-05 NISSAN PASSENGER CAR 1995-99</p>	 <p>ST-3915</p> <p>ST-3915 STRUT MOUNT(Rear)</p> <p>BMW PASSENGER CAR 1988-95</p>	 <p>ST-3919</p> <p>ST-3919 STRUT MOUNT(Front)</p> <p>BMW PASSENGER CAR 1997-03</p>	 <p>ST-3923</p> <p>ST-3923 STRUT MOUNT(Rear)</p> <p>BMW SPORT UTILITY 2000-05</p>
 <p>ST-3912</p> <p>ST-3912 STRUT MOUNT(Front)</p> <p>AUDI PASSENGER CAR 1992-97</p>	 <p>ST-3916</p> <p>ST-3916 STRUT MOUNT(Front) (RIGHT)</p> <p>BMW PASSENGER CAR 1995-99</p>	 <p>ST-3920</p> <p>ST-3920 STRUT MOUNT(Rear)</p> <p>BMW PASSENGER CAR 1993-03</p>	 <p>ST-3924</p> <p>ST-3924 STRUT MOUNT(Rear)</p> <p>CHRYSLER PASSENGER CAR 2000-02 DODGE PASSENGER CAR 2000-05 PLYMOUTH PASSENGER CAR 2000-01</p>
 <p>ST-3913</p> <p>ST-3913 STRUT MOUNT(Rear)</p> <p>AUDI PASSENGER CAR 1989-97</p>	 <p>ST-3917</p> <p>ST-3917 STRUT MOUNT(Front) (LEFT)</p> <p>BMW PASSENGER CAR 1995-99</p>	 <p>ST-3921</p> <p>ST-3921 STRUT MOUNT(Rear)</p> <p>BMW PASSENGER CAR 1996-03</p>	

BUYER'S GUIDE

NUMERICAL LISTING - ILLUSTRATIONS

 <p style="text-align: center;">ST-3926 STRUT MOUNT(Front)</p> <p>CHRYSLER PASSENGER CAR 2000-09 DODGE PASSENGER CAR 2000-05 PLYMOUTH PASSENGER CAR 2000-01</p>	 <p style="text-align: center;">ST-3932 STRUT MOUNT(Front)</p> <p>CADILLAC PASSENGER CAR 1997-01 PONTIAC PASSENGER CAR 2004-09</p>	 <p style="text-align: center;">ST-3936 STRUT MOUNT(Rear) (RIGHT)</p> <p>HYUNDAI PASSENGER CAR 1996-08 HYUNDAI SPORT UTILITY 2005-10 KIA PASSENGER CAR 2004-09 KIA SPORT UTILITY 2005-10</p>	<p style="text-align: center;">ST-3939 (Continued)</p> <p>HYUNDAI PASSENGER CAR 1995-05</p>  <p style="text-align: center;">ST-3940 STRUT MOUNT(Rear) (LEFT)</p> <p>KIA PASSENGER CAR 1995-01</p>
 <p style="text-align: center;">ST-3928 STRUT MOUNT(Front)</p> <p>FORD PASSENGER CAR 2000-07</p>	 <p style="text-align: center;">ST-3933 STRUT MOUNT(Front) (UPPER SPR ISO)</p> <p>CHEVROLET PASSENGER CAR 1993-02 PONTIAC PASSENGER CAR 1993-02</p>	 <p style="text-align: center;">ST-3937 STRUT MOUNT(Rear)</p> <p>HYUNDAI PASSENGER CAR 1999-00</p>	 <p style="text-align: center;">ST-3941 STRUT MOUNT(Rear) (RIGHT)</p> <p>KIA PASSENGER CAR 1995-01</p>
 <p style="text-align: center;">ST-3929 STRUT MOUNT(Rear)</p> <p>CADILLAC PASSENGER CAR 1994-02</p>	 <p style="text-align: center;">ST-3935 STRUT MOUNT(Rear) (LEFT)</p> <p>HYUNDAI PASSENGER CAR 1996-08 HYUNDAI SPORT UTILITY 2005-10 KIA PASSENGER CAR 2004-09 KIA SPORT UTILITY 2005-10</p>	 <p style="text-align: center;">ST-3938 STRUT MOUNT(Front)</p> <p>HYUNDAI PASSENGER CAR 2000-05</p>	 <p style="text-align: center;">ST-3942 STRUT MOUNT(Front) (LEFT)</p> <p>KIA PASSENGER CAR 1995-97</p>
 <p style="text-align: center;">ST-3930 STRUT MOUNT(Front)</p> <p>CADILLAC PASSENGER CAR 1994-97</p>	 <p style="text-align: center;">ST-3939 STRUT MOUNT(Rear)</p> <p>DAIHATSU PASSENGER CAR ... 1988-92</p> <p style="text-align: center;">(Continued Next Column)</p>	 <p style="text-align: center;">ST-3943 STRUT MOUNT(Front)</p> <p>MAZDA PASSENGER CAR 1990-01</p>	

BUYER'S GUIDE

NUMERICAL LISTING - ILLUSTRATIONS

 <p>ST-3944</p> <p>ST-3944 STRUT MOUNT(Front) MERCEDES-BENZ PASSENGER CAR 1994-02</p>	 <p>ST-3948</p> <p>ST-3948 STRUT MOUNT(Front) MITSUBISHI PASSENGER CAR 1983-88</p>	 <p>ST-3954</p> <p>ST-3954 STRUT MOUNT(Front) INFINITI SPORT UTILITY 1997-03 NISSAN SPORT UTILITY 1996-04</p>	 <p>ST-3960</p> <p>ST-3960 STRUT MOUNT(Front) SAAB PASSENGER CAR 1994-98</p>
 <p>ST-3945</p> <p>ST-3945 STRUT MOUNT(Front) MITSUBISHI PASSENGER CAR 1997</p>	 <p>ST-3949</p> <p>ST-3949 STRUT MOUNT(Front) NISSAN PASSENGER CAR 1984-88</p>	 <p>ST-3957</p> <p>ST-3957 STRUT MOUNT(Front) NISSAN PASSENGER CAR 2000-01</p>	 <p>ST-3961</p> <p>ST-3961 STRUT MOUNT(Front) SAAB PASSENGER CAR 1999-02</p>
 <p>ST-3946</p> <p>ST-3946 STRUT MOUNT(Front) MITSUBISHI PASSENGER CAR 1989-90</p>	 <p>ST-3950</p> <p>ST-3950 STRUT MOUNT(Front) NISSAN PASSENGER CAR 2000-06</p>	 <p>ST-3958</p> <p>ST-3958 STRUT MOUNT(Front) INFINITI PASSENGER CAR 1997-05</p>	 <p>ST-3962</p> <p>ST-3962 STRUT MOUNT(Rear) (UPPER SPR SEAT) VOLKSWAGEN PASSENGER CAR 1985-02</p>
 <p>ST-3947</p> <p>ST-3947 STRUT MOUNT(Front) MITSUBISHI PASSENGER CAR 1997-02</p>	 <p>ST-3951</p> <p>ST-3951 STRUT MOUNT(Front) NISSAN PASSENGER CAR 1984-89</p>	 <p>ST-3959</p> <p>ST-3959 STRUT MOUNT(Front) SAAB PASSENGER CAR 1999-08</p>	 <p>ST-3964</p> <p>ST-3964 STRUT MOUNT(Front) (UPPER SPR SEAT) FORD PASSENGER CAR 1993-97 MAZDA PASSENGER CAR 1993-02</p>

BUYER'S GUIDE

NUMERICAL LISTING - ILLUSTRATIONS

 <p style="text-align: center;">ST-3965</p> <p style="text-align: center;">ST-3965 STRUT MOUNT(Front) (UPPER SPR SEAT & ISO)</p> <p>FORD PASSENGER CAR 1991-96 MERCURY PASSENGER CAR ... 1991-96</p>	<p>ST-3968 (Continued)</p> <p>FORD PASSENGER CAR 1996-07 MERCURY PASSENGER CAR ... 1996-05</p>  <p style="text-align: center;">ST-3969</p> <p style="text-align: center;">ST-3969 STRUT MOUNT(Front) (UPPER SPR SEAT & ISO)</p> <p>BUICK PASSENGER CAR 1982-91 CADILLAC PASSENGER CAR 1982-88 CHEVROLET PASSENGER CAR 1982-94 OLDSMOBILE PASSENGER CAR 1982-91 PONTIAC PASSENGER CAR 1982-94</p>	<p>ST-3971 (Continued)</p> <p>OLDSMOBILE VAN 1990-96 PONTIAC PASSENGER CAR 1984-91 PONTIAC VAN 1990-96</p>  <p style="text-align: center;">ST-3972</p> <p style="text-align: center;">ST-3972 STRUT MOUNT(Front) (UPPER SPR SEAT & ISO)</p> <p>BUICK PASSENGER CAR 1990-94 CHEVROLET PASSENGER CAR 1992-94 OLDSMOBILE PASSENGER CAR 1992-94 PONTIAC PASSENGER CAR 1992-94</p>	 <p style="text-align: center;">ST-3975</p> <p style="text-align: center;">ST-3975 STRUT MOUNT(Front) (UPPER SPR SEAT)</p> <p>CHRYSLER VAN 1995-00 DODGE VAN 1995-00 PLYMOUTH VAN 1995-00</p>
 <p style="text-align: center;">ST-3966</p> <p style="text-align: center;">ST-3966 STRUT MOUNT(Rear) (UPPER SPR ISO)</p> <p>FORD PASSENGER CAR 1984-94 MERCURY PASSENGER CAR ... 1984-94</p>	 <p style="text-align: center;">ST-3970</p> <p style="text-align: center;">ST-3970 STRUT MOUNT(Front) (UPPER SPR SEAT & ISO)</p> <p>BUICK PASSENGER CAR 1995-98 CHEVROLET PASSENGER CAR 1994-96 OLDSMOBILE PASSENGER CAR 1995-98 PONTIAC PASSENGER CAR 1995-98</p>	 <p style="text-align: center;">ST-3973</p> <p style="text-align: center;">ST-3973 STRUT MOUNT(Front) (UPPER SPR SEAT & ISO)</p> <p>BUICK PASSENGER CAR 1990-99 CADILLAC PASSENGER CAR 1991-93 OLDSMOBILE PASSENGER CAR 1990-99 PONTIAC PASSENGER CAR 1990-99 PONTIAC SPORT UTILITY 2001-05</p>	 <p style="text-align: center;">ST-3976</p> <p style="text-align: center;">ST-3976 STRUT MOUNT(Front) (UPPER SPR SEAT & ISO)</p> <p>DODGE PASSENGER CAR 1995-99 PLYMOUTH PASSENGER CAR 1995-99</p>
 <p style="text-align: center;">ST-3967</p> <p style="text-align: center;">ST-3967 STRUT MOUNT(Front) (UPPER SPR SEAT)</p> <p>FORD PASSENGER CAR 1986-95 MERCURY PASSENGER CAR ... 1986-95</p>	 <p style="text-align: center;">ST-3971</p> <p style="text-align: center;">ST-3971 STRUT MOUNT(Front) (UPPER SPR SEAT & ISO)</p> <p>BUICK PASSENGER CAR 1984-96 CHEVROLET PASSENGER CAR 1984-90 CHEVROLET VAN 1990-96 OLDSMOBILE PASSENGER CAR 1984-96</p>	 <p style="text-align: center;">ST-3974</p> <p style="text-align: center;">ST-3974 STRUT MOUNT(Front) (UPPER SPR SEAT & ISO)</p> <p>BUICK PASSENGER CAR 1985-90 CADILLAC PASSENGER CAR 1985-90 OLDSMOBILE PASSENGER CAR 1985-90 PONTIAC PASSENGER CAR 1987-90</p>	 <p style="text-align: center;">ST-3977</p> <p style="text-align: center;">ST-3977 STRUT MOUNT(Front) (UPPER SPR SEAT)</p> <p>CHRYSLER PASSENGER CAR 1993-97 DODGE PASSENGER CAR 1993-97 EAGLE PASSENGER CAR 1993-97</p>
 <p style="text-align: center;">ST-3968</p> <p style="text-align: center;">ST-3968 STRUT MOUNT(Front) (UPPER SPR SEAT)</p> <p style="text-align: center;">(Continued Next Column)</p>	<p style="text-align: center;">(Continued Next Column)</p>	<p style="text-align: center;">(Continued Next Column)</p>	<p style="text-align: center;">(Continued Next Column)</p>

BUYER'S GUIDE

NUMERICAL LISTING - ILLUSTRATIONS

 <p style="text-align: center;">ST-3978 STRUT MOUNT(Front) (UPPER SPR SEAT) VOLVO PASSENGER CAR 1993-07 VOLVO SPORT UTILITY 2003-14</p>	 <p style="text-align: center;">ST-3983 STRUT MOUNT(Rear) SUBARU PASSENGER CAR 1992-01</p>	 <p style="text-align: center;">ST-3987 STRUT MOUNT(Rear) (LEFT) SUBARU PASSENGER CAR 1995-03 SUBARU SPORT UTILITY 1998-02</p>	 <p style="text-align: center;">ST-3991 STRUT MOUNT(Front) LEXUS PASSENGER CAR 1995-96 TOYOTA PASSENGER CAR 1995-96</p>
 <p style="text-align: center;">ST-3980 STRUT MOUNT(Front) (LOWER SPR ISO) CHRYSLER PASSENGER CAR 1986-95 CHRYSLER VAN 1990-95 DODGE PASSENGER CAR 1986-95 DODGE VAN 1986-95 PLYMOUTH PASSENGER CAR 1986-95 PLYMOUTH VAN 1986-95</p>	 <p style="text-align: center;">ST-3984 STRUT MOUNT(Rear) SUBARU PASSENGER CAR 1985-94</p>	 <p style="text-align: center;">ST-3988 STRUT MOUNT(Rear) (RIGHT) SUBARU PASSENGER CAR 1995-96</p>	 <p style="text-align: center;">ST-3992 STRUT MOUNT(Front) TOYOTA PASSENGER CAR 1994-99</p>
 <p style="text-align: center;">ST-3982 STRUT MOUNT(Rear) (UPPER SPR SEAT) HONDA PASSENGER CAR 1992-01</p>	 <p style="text-align: center;">ST-3985 STRUT MOUNT(Rear) SUBARU PASSENGER CAR 1985-91</p>	 <p style="text-align: center;">ST-3989 STRUT MOUNT(Rear) (LEFT) SUBARU PASSENGER CAR 1995-96</p>	 <p style="text-align: center;">ST-3993 STRUT MOUNT(Rear) TOYOTA PASSENGER CAR 1986-93</p>
 <p style="text-align: center;">ST-3986 STRUT MOUNT(Rear) (RIGHT) SUBARU PASSENGER CAR 1995-03 SUBARU SPORT UTILITY 1998-02</p>	 <p style="text-align: center;">ST-3990 STRUT MOUNT(Front) TOYOTA PASSENGER CAR 1991-95</p>	 <p style="text-align: center;">ST-3994 STRUT MOUNT(Front) TOYOTA PASSENGER CAR 1986-93</p>	

BUYER'S GUIDE

NUMERICAL LISTING - ILLUSTRATIONS

 <p>ST-3995</p> <p>ST-3995 STRUT MOUNT(Front)</p> <p>TOYOTA SPORT UTILITY 1996-05</p>	 <p>ST-4900</p> <p>ST-4900 STRUT MOUNT(Front)</p> <p>TOYOTA SPORT UTILITY 1996-02</p>	 <p>ST-4905</p> <p>ST-4905 STRUT MOUNT(Front)</p> <p>AUDI PASSENGER CAR 2000-06 VOLKSWAGEN PASSENGER CAR 1998-10</p>	 <p>ST-4909</p> <p>ST-4909 STRUT MOUNT(Rear)</p> <p>AUDI PASSENGER CAR 1997-04 VOLKSWAGEN PASSENGER CAR 1998-05</p>
 <p>ST-3997</p> <p>ST-3997 STRUT MOUNT(Front)</p> <p>LEXUS PASSENGER CAR 1993-08</p>	 <p>ST-4902</p> <p>ST-4902 STRUT MOUNT(Rear)</p> <p>LEXUS PASSENGER CAR 1992-00 TOYOTA PASSENGER CAR 1994-98</p>	 <p>ST-4906</p> <p>ST-4906 STRUT MOUNT(Rear)</p> <p>VOLKSWAGEN PASSENGER CAR 1987-93</p>	 <p>ST-4910</p> <p>ST-4910 STRUT MOUNT(Rear)</p> <p>AUDI PASSENGER CAR 2000-06 SHOCK MOUNT (REAR)</p> <p>SEAT PASSENGER CAR 2001-19 STRUT MOUNT(Rear)</p> <p>VOLKSWAGEN PASSENGER CAR 1998-10</p>
 <p>ST-3998</p> <p>ST-3998 STRUT MOUNT(Front)</p> <p>LEXUS PASSENGER CAR 1990-04</p>	 <p>ST-4903</p> <p>ST-4903 STRUT MOUNT(Front)</p> <p>VOLVO PASSENGER CAR 1993-07 VOLVO SPORT UTILITY 2003-14</p>	 <p>ST-4907</p> <p>ST-4907 STRUT MOUNT(Rear)</p> <p>AUDI PASSENGER CAR 1996-06 VOLKSWAGEN PASSENGER CAR 1982-88</p>	 <p>ST-4911</p> <p>ST-4911 STRUT MOUNT(Rear)</p>
 <p>ST-3999</p> <p>ST-3999 STRUT MOUNT(Rear)</p> <p>LEXUS PASSENGER CAR 1995-00</p>	 <p>ST-4904</p> <p>ST-4904 STRUT MOUNT(Rear)</p> <p>VOLVO PASSENGER CAR 1993-04</p>	 <p>ST-4908</p> <p>ST-4908 STRUT MOUNT(Front)</p> <p>AUDI PASSENGER CAR 1996-07 VOLKSWAGEN PASSENGER CAR 1998-00</p>	 <p>ST-4911</p> <p>ST-4911 STRUT MOUNT(Front)</p> <p>LINCOLN PASSENGER CAR 1997-02</p>

BUYER'S GUIDE

NUMERICAL LISTING - ILLUSTRATIONS

 <p style="text-align: center;">ST-4912 STRUT MOUNT(Front)</p> <table style="width: 100%; border-collapse: collapse;"> <tr> <td>BUICK PASSENGER CAR</td> <td>1995-98</td> </tr> <tr> <td>CHEVROLET PASSENGER CAR</td> <td>1995-99</td> </tr> <tr> <td>OLDSMOBILE PASSENGER CAR</td> <td>1995-98</td> </tr> <tr> <td>PONTIAC PASSENGER CAR</td> <td>1995-99</td> </tr> </table>	BUICK PASSENGER CAR	1995-98	CHEVROLET PASSENGER CAR	1995-99	OLDSMOBILE PASSENGER CAR	1995-98	PONTIAC PASSENGER CAR	1995-99	 <p style="text-align: center;">ST-4916 STRUT MOUNT(Front) (UPPER SPR SEAT & ISO)</p> <table style="width: 100%; border-collapse: collapse;"> <tr> <td>CHRYSLER PASSENGER CAR</td> <td>1986-95</td> </tr> <tr> <td>CHRYSLER VAN</td> <td>1990-95</td> </tr> <tr> <td>DODGE PASSENGER CAR</td> <td>1986-95</td> </tr> <tr> <td>DODGE VAN</td> <td>1986-95</td> </tr> <tr> <td>PLYMOUTH PASSENGER CAR</td> <td>1986-95</td> </tr> <tr> <td>PLYMOUTH VAN</td> <td>1986-95</td> </tr> </table>	CHRYSLER PASSENGER CAR	1986-95	CHRYSLER VAN	1990-95	DODGE PASSENGER CAR	1986-95	DODGE VAN	1986-95	PLYMOUTH PASSENGER CAR	1986-95	PLYMOUTH VAN	1986-95	 <p style="text-align: center;">ST-4920 STRUT MOUNT(Front) (LOWER SPR ISO)</p> <table style="width: 100%; border-collapse: collapse;"> <tr> <td>FORD PASSENGER CAR</td> <td>1989-97</td> </tr> <tr> <td>MERCURY PASSENGER CAR</td> <td>1989-97</td> </tr> </table>	FORD PASSENGER CAR	1989-97	MERCURY PASSENGER CAR	1989-97	 <p style="text-align: center;">ST-4923 STRUT MOUNT(Front) (LOWER SPR ISO)</p> <table style="width: 100%; border-collapse: collapse;"> <tr> <td>BUICK PASSENGER CAR</td> <td>1985-90</td> </tr> <tr> <td>CADILLAC PASSENGER CAR</td> <td>1985-90</td> </tr> <tr> <td>OLDSMOBILE PASSENGER CAR</td> <td>1985-90</td> </tr> <tr> <td>PONTIAC PASSENGER CAR</td> <td>1987-90</td> </tr> </table>	BUICK PASSENGER CAR	1985-90	CADILLAC PASSENGER CAR	1985-90	OLDSMOBILE PASSENGER CAR	1985-90	PONTIAC PASSENGER CAR	1987-90
BUICK PASSENGER CAR	1995-98																																		
CHEVROLET PASSENGER CAR	1995-99																																		
OLDSMOBILE PASSENGER CAR	1995-98																																		
PONTIAC PASSENGER CAR	1995-99																																		
CHRYSLER PASSENGER CAR	1986-95																																		
CHRYSLER VAN	1990-95																																		
DODGE PASSENGER CAR	1986-95																																		
DODGE VAN	1986-95																																		
PLYMOUTH PASSENGER CAR	1986-95																																		
PLYMOUTH VAN	1986-95																																		
FORD PASSENGER CAR	1989-97																																		
MERCURY PASSENGER CAR	1989-97																																		
BUICK PASSENGER CAR	1985-90																																		
CADILLAC PASSENGER CAR	1985-90																																		
OLDSMOBILE PASSENGER CAR	1985-90																																		
PONTIAC PASSENGER CAR	1987-90																																		
 <p style="text-align: center;">ST-4913 STRUT MOUNT(Front)</p> <table style="width: 100%; border-collapse: collapse;"> <tr> <td>FORD PASSENGER CAR</td> <td>1997-03</td> </tr> <tr> <td>MERCURY PASSENGER CAR</td> <td>1997-99</td> </tr> </table> <p style="text-align: center;">STRUT MOUNT(Rear)</p> <table style="width: 100%; border-collapse: collapse;"> <tr> <td>AUDI PASSENGER CAR</td> <td>1995-97</td> </tr> </table>	FORD PASSENGER CAR	1997-03	MERCURY PASSENGER CAR	1997-99	AUDI PASSENGER CAR	1995-97	 <p style="text-align: center;">ST-4918 STRUT MOUNT(Rear)</p> <table style="width: 100%; border-collapse: collapse;"> <tr> <td>LEXUS PASSENGER CAR</td> <td>1990-94</td> </tr> </table>	LEXUS PASSENGER CAR	1990-94	 <p style="text-align: center;">ST-4921 STRUT MOUNT(Front) (LOWER SPR ISO)</p> <table style="width: 100%; border-collapse: collapse;"> <tr> <td>CHRYSLER VAN</td> <td>1995-00</td> </tr> <tr> <td>DODGE VAN</td> <td>1995-00</td> </tr> <tr> <td>PLYMOUTH VAN</td> <td>1995-00</td> </tr> </table>	CHRYSLER VAN	1995-00	DODGE VAN	1995-00	PLYMOUTH VAN	1995-00	 <p style="text-align: center;">ST-4924 STRUT MOUNT(Front) (LOWER SPR ISO)</p> <table style="width: 100%; border-collapse: collapse;"> <tr> <td>BUICK PASSENGER CAR</td> <td>1983-91</td> </tr> <tr> <td>CADILLAC PASSENGER CAR</td> <td>1983-88</td> </tr> <tr> <td>CHEVROLET PASSENGER CAR</td> <td>1983-91</td> </tr> <tr> <td>OLDSMOBILE PASSENGER CAR</td> <td>1983-91</td> </tr> <tr> <td>PONTIAC PASSENGER CAR</td> <td>1982-91</td> </tr> </table>	BUICK PASSENGER CAR	1983-91	CADILLAC PASSENGER CAR	1983-88	CHEVROLET PASSENGER CAR	1983-91	OLDSMOBILE PASSENGER CAR	1983-91	PONTIAC PASSENGER CAR	1982-91								
FORD PASSENGER CAR	1997-03																																		
MERCURY PASSENGER CAR	1997-99																																		
AUDI PASSENGER CAR	1995-97																																		
LEXUS PASSENGER CAR	1990-94																																		
CHRYSLER VAN	1995-00																																		
DODGE VAN	1995-00																																		
PLYMOUTH VAN	1995-00																																		
BUICK PASSENGER CAR	1983-91																																		
CADILLAC PASSENGER CAR	1983-88																																		
CHEVROLET PASSENGER CAR	1983-91																																		
OLDSMOBILE PASSENGER CAR	1983-91																																		
PONTIAC PASSENGER CAR	1982-91																																		
 <p style="text-align: center;">ST-4915 STRUT MOUNT(Front)</p> <table style="width: 100%; border-collapse: collapse;"> <tr> <td>SATURN PASSENGER CAR</td> <td>2000-05</td> </tr> </table>	SATURN PASSENGER CAR	2000-05	 <p style="text-align: center;">ST-4919 STRUT MOUNT(Front)</p> <table style="width: 100%; border-collapse: collapse;"> <tr> <td>CHEVROLET PASSENGER CAR</td> <td>2000-05</td> </tr> <tr> <td>PONTIAC PASSENGER CAR</td> <td>1999-05</td> </tr> </table>	CHEVROLET PASSENGER CAR	2000-05	PONTIAC PASSENGER CAR	1999-05	 <p style="text-align: center;">ST-4922 STRUT MOUNT(Front) (LOWER SPR ISO)</p> <table style="width: 100%; border-collapse: collapse;"> <tr> <td>FORD PASSENGER CAR</td> <td>1997-03</td> </tr> </table> <p style="text-align: center;">STRUT MOUNT(Rear) (LOWER SPR ISO)</p> <table style="width: 100%; border-collapse: collapse;"> <tr> <td>FORD PASSENGER CAR</td> <td>1991-96</td> </tr> <tr> <td>MERCURY PASSENGER CAR</td> <td>1991-99</td> </tr> </table>	FORD PASSENGER CAR	1997-03	FORD PASSENGER CAR	1991-96	MERCURY PASSENGER CAR	1991-99	 <p style="text-align: center;">ST-4925 STRUT MOUNT(Front) (LOWER SPR ISO)</p> <table style="width: 100%; border-collapse: collapse;"> <tr> <td>BUICK PASSENGER CAR</td> <td>1990-99</td> </tr> <tr> <td>CADILLAC PASSENGER CAR</td> <td>1991-93</td> </tr> <tr> <td>OLDSMOBILE PASSENGER CAR</td> <td>1990-99</td> </tr> <tr> <td>PONTIAC PASSENGER CAR</td> <td>1990-99</td> </tr> </table>	BUICK PASSENGER CAR	1990-99	CADILLAC PASSENGER CAR	1991-93	OLDSMOBILE PASSENGER CAR	1990-99	PONTIAC PASSENGER CAR	1990-99												
SATURN PASSENGER CAR	2000-05																																		
CHEVROLET PASSENGER CAR	2000-05																																		
PONTIAC PASSENGER CAR	1999-05																																		
FORD PASSENGER CAR	1997-03																																		
FORD PASSENGER CAR	1991-96																																		
MERCURY PASSENGER CAR	1991-99																																		
BUICK PASSENGER CAR	1990-99																																		
CADILLAC PASSENGER CAR	1991-93																																		
OLDSMOBILE PASSENGER CAR	1990-99																																		
PONTIAC PASSENGER CAR	1990-99																																		

BUYER'S GUIDE

NUMERICAL LISTING - ILLUSTRATIONS

 <p style="text-align: center;">ST-4927 STRUT MOUNT(Rear)</p> <p>FORD PASSENGER CAR 2000-11</p>	 <p style="text-align: center;">ST-4935 STRUT MOUNT(Front)</p> <p>PONTIAC PASSENGER CAR 2003-08 TOYOTA PASSENGER CAR 2000-08</p>	 <p style="text-align: center;">ST-4938 STRUT MOUNT(Front)</p> <p>FORD SPORT UTILITY 2001-12 MAZDA SPORT UTILITY 2001-11 MERCURY SPORT UTILITY 2005-11</p>	<p>ST-4941 (Continued)</p> <p>PONTIAC PASSENGER CAR 1997-03</p>  <p style="text-align: center;">ST-4942 STRUT MOUNT(Front) (UPPER SPR ISO)</p> <p>BUICK PASSENGER CAR 1997-05 BUICK SPORT UTILITY 2002-07 BUICK VAN 2005-07 CHEVROLET PASSENGER CAR 2000-13 CHEVROLET VAN 1997-09 OLDSMOBILE VAN 1997-04 PONTIAC PASSENGER CAR 1997-03 PONTIAC SPORT UTILITY 2001-05 PONTIAC VAN 1997-09 SATURN VAN 2005-07</p>
 <p style="text-align: center;">ST-4932 STRUT MOUNT(Front)</p> <p>CHEVROLET SPORT UTILITY 1999-04 SUZUKI SPORT UTILITY 1999-06</p>	 <p style="text-align: center;">ST-4936 STRUT MOUNT(Front) (UPPER SPR SEAT & ISO)</p> <p>FORD PASSENGER CAR 1997-03 MERCURY PASSENGER CAR ... 1997-99</p>	 <p style="text-align: center;">ST-4939 STRUT MOUNT(Front) (UPPER SPR ISO)</p> <p>CHEVROLET PASSENGER CAR 1995-05 PONTIAC PASSENGER CAR 1999-05</p>	 <p style="text-align: center;">ST-4943 STRUT MOUNT(Front) (LOWER SPR ISO)</p> <p>BUICK PASSENGER CAR 1997-05 BUICK SPORT UTILITY 2002-07 BUICK VAN 2005-07 CHEVROLET PASSENGER CAR 2000-13 CHEVROLET VAN 1997-09 OLDSMOBILE VAN 1997-04 PONTIAC PASSENGER CAR 1997-03 PONTIAC SPORT UTILITY 2001-05 PONTIAC VAN 1997-09 SATURN VAN 2005-07</p>
 <p style="text-align: center;">ST-4933 STRUT MOUNT(Front)</p> <p>CHEVROLET SPORT UTILITY 1999-02 SUZUKI SPORT UTILITY 1999-02</p>	 <p style="text-align: center;">ST-4937 STRUT MOUNT(Front) (LOWER SPR ISO)</p> <p>FORD PASSENGER CAR 1996-07 MERCURY PASSENGER CAR ... 1996-05</p>	 <p style="text-align: center;">ST-4940 STRUT MOUNT(Front) (LOWER SPR ISO)</p> <p>CHEVROLET PASSENGER CAR 1995-05 PONTIAC PASSENGER CAR 1995-05</p>	 <p style="text-align: center;">ST-4944 STRUT MOUNT(Front) (UPPER SPR ISO)</p> <p>CHEVROLET PASSENGER CAR 1997-05 OLDSMOBILE PASSENGER CAR 1997-04</p>
 <p style="text-align: center;">ST-4934 STRUT MOUNT(Rear)</p> <p>SUBARU PASSENGER CAR 2000-09 SUBARU SPORT UTILITY 2000-09</p>	 <p style="text-align: center;">ST-4941 STRUT MOUNT(Rear) (LOWER SPR ISO)</p> <p>BUICK PASSENGER CAR 1997-05 CHEVROLET PASSENGER CAR 2000-13</p> <p style="text-align: center;">(Continued Next Column)</p>	 <p style="text-align: center;">ST-4941 STRUT MOUNT(Rear) (LOWER SPR ISO)</p> <p>BUICK PASSENGER CAR 1997-05 CHEVROLET PASSENGER CAR 2000-13</p> <p style="text-align: center;">(Continued Next Page)</p>	<p style="text-align: center;">ST-4941 STRUT MOUNT(Rear) (LOWER SPR ISO)</p> <p>BUICK PASSENGER CAR 1997-05 CHEVROLET PASSENGER CAR 2000-13</p> <p style="text-align: center;">(Continued Next Page)</p>

BUYER'S GUIDE

NUMERICAL LISTING - ILLUSTRATIONS

<p>ST-4944 (Continued) PONTIAC PASSENGER CAR 1999-05</p>  <p style="text-align: center;">ST-4945</p> <p>ST-4945 STRUT MOUNT(Front) (LOWER SPR ISO) CHEVROLET PASSENGER CAR 1997-05 OLDSMOBILE PASSENGER CAR 1997-04 PONTIAC PASSENGER CAR 1999-05</p>  <p style="text-align: center;">ST-4948</p> <p>ST-4948 STRUT MOUNT(Rear) (LOWER SPR ISO) DODGE PASSENGER CAR 1995-99 PLYMOUTH PASSENGER CAR 1995-99</p>  <p style="text-align: center;">ST-4949</p> <p>ST-4949 STRUT MOUNT(Front) (LOWER SPR ISO) FORD VAN 1995-03</p>  <p style="text-align: center;">ST-4950</p> <p>ST-4950 STRUT MOUNT(Front) (UPPER SPR SEAT & ISO) LEXUS PASSENGER CAR 1995-03 (Continued Next Column)</p>	<p>ST-4950 (Continued) TOYOTA PASSENGER CAR 1995-03</p>  <p style="text-align: center;">ST-4951</p> <p>ST-4951 STRUT MOUNT(Front) (LOWER SPR ISO) LEXUS PASSENGER CAR 1995-03 TOYOTA PASSENGER CAR 1995-03</p>  <p style="text-align: center;">ST-4952</p> <p>ST-4952 STRUT MOUNT(Rear) (UPPER SPR ISO) LEXUS PASSENGER CAR 1992-96 TOYOTA PASSENGER CAR 1992-96</p>  <p style="text-align: center;">ST-4953</p> <p>ST-4953 STRUT MOUNT(Rear) (LOWER SPR ISO) LEXUS PASSENGER CAR 1992-03 TOYOTA PASSENGER CAR 1992-03</p>	 <p style="text-align: center;">ST-4954</p> <p>ST-4954 STRUT MOUNT(Front) (LEFT) MAZDA PASSENGER CAR 1998-02</p>  <p style="text-align: center;">ST-4955</p> <p>ST-4955 STRUT MOUNT(Rear) NISSAN PASSENGER CAR 2000-06</p>  <p style="text-align: center;">ST-4956</p> <p>ST-4956 STRUT MOUNT(Front) (UPPER SPR SEAT & ISO) DODGE PASSENGER CAR 2000-05</p>  <p style="text-align: center;">ST-4957</p> <p>ST-4957 STRUT MOUNT(Front) CHRYSLER PASSENGER CAR 2001-05 DODGE PASSENGER CAR 2001-05 HYUNDAI SPORT UTILITY 2001-10 MITSUBISHI PASSENGER CAR 1999-05</p>	 <p style="text-align: center;">ST-4958</p> <p>ST-4958 STRUT MOUNT(Front) MAZDA VAN 2000-06</p>  <p style="text-align: center;">ST-4962</p> <p>ST-4962 STRUT MOUNT(Front) (LOWER SPR SEAT) CHEVROLET PASSENGER CAR 1993-02 ISUZU SPORT UTILITY 2003-08 PONTIAC PASSENGER CAR 1993-02</p>  <p style="text-align: center;">ST-4965</p> <p>ST-4965 STRUT MOUNT(Rear) AUDI PASSENGER CAR 2001-07</p>  <p style="text-align: center;">ST-4966</p> <p>ST-4966 STRUT MOUNT(Rear) BMW PASSENGER CAR 2000-06</p>
---	--	---	---

BUYER'S GUIDE

NUMERICAL LISTING - ILLUSTRATIONS

 <p style="text-align: center;">ST-4968 STRUT MOUNT(Front)</p> <p>BUICK SPORT UTILITY 2004-07 CHEVROLET SPORT UTILITY 2002-09 CHEVROLET TRUCK 2004-06 GMC SPORT UTILITY 2002-08 ISUZU SPORT UTILITY 2003-08 OLDSMOBILE SPORT UTILITY .. 2002-04 SAAB SUV 2005-09</p>	 <p style="text-align: center;">ST-4973 STRUT MOUNT(Rear)</p> <p>FORD SPORT UTILITY 2003-06</p>	 <p style="text-align: center;">ST-4977 STRUT MOUNT(Rear)</p> <p>ACURA PASSENGER CAR 1996-04</p>	 <p style="text-align: center;">ST-4983 STRUT MOUNT(Front)</p> <p>MAZDA PASSENGER CAR 1999-03</p>
 <p style="text-align: center;">ST-4970 STRUT MOUNT(Front)</p> <p>FORD TRUCK 2004-08 LINCOLN TRUCK 2006-08</p>	 <p style="text-align: center;">ST-4974 STRUT MOUNT(Front)</p> <p>FORD SPORT UTILITY 2003-06</p>	 <p style="text-align: center;">ST-4979 STRUT MOUNT(Rear)</p> <p>INFINITI PASSENGER CAR 2000-04 NISSAN PASSENGER CAR 2000-03</p>	 <p style="text-align: center;">ST-4984 STRUT MOUNT(Front)</p> <p>MITSUBISHI SPORT UTILITY 2001-03</p>
 <p style="text-align: center;">ST-4971 STRUT MOUNT(Front)</p> <p>FORD VAN 2004-07 MERCURY VAN 2004-07</p>	 <p style="text-align: center;">ST-4975 STRUT MOUNT(Front)</p> <p>ACURA SPORT UTILITY 2001-06 HONDA SPORT UTILITY 2003-08 HONDA VAN 1999-04</p>	 <p style="text-align: center;">ST-4980 STRUT MOUNT(Front)</p> <p>KIA PASSENGER CAR 2001-02</p>	 <p style="text-align: center;">ST-4985 STRUT MOUNT(Rear)</p> <p>NISSAN PASSENGER CAR 2002-08</p>
 <p style="text-align: center;">ST-4972 STRUT MOUNT(Front)</p> <p>FORD PASSENGER CAR 2002-05 JAGUAR 2000-05 LINCOLN PASSENGER CAR 2000-06</p> <p style="text-align: center;">STRUT MOUNT(Rear)</p> <p>FORD PASSENGER CAR 2002-05 JAGUAR 2000-05 LINCOLN PASSENGER CAR 2000-06</p>	 <p style="text-align: center;">ST-4976 STRUT MOUNT(Front)</p> <p>ACURA PASSENGER CAR 1996-04</p>	 <p style="text-align: center;">ST-4981 STRUT MOUNT(Front)</p> <p>KIA SPORT UTILITY 1995-02</p>	 <p style="text-align: center;">ST-4987 STRUT MOUNT(Rear)</p> <p>SATURN PASSENGER CAR 2000-05</p>

BUYER'S GUIDE

NUMERICAL LISTING - ILLUSTRATIONS

 <p style="text-align: center;">ST-4988 STRUT MOUNT(Front)</p> <p>SCION PASSENGER CAR 2004-05 SCION VAN 2004-06 TOYOTA PASSENGER CAR 2000-05</p>	 <p style="text-align: center;">ST-4992 STRUT MOUNT(Front)</p> <p>AUDI PASSENGER CAR 2007 VOLKSWAGEN PASSENGER CAR 2001-05</p>	 <p style="text-align: center;">ST-4996 STRUT MOUNT(Front) (RIGHT)</p> <p>ACURA PASSENGER CAR 2005-06 HONDA PASSENGER CAR 2002-05</p>	 <p style="text-align: center;">ST-5900 STRUT MOUNT(Front)</p> <p>TOYOTA PASSENGER CAR 2000-05</p>
 <p style="text-align: center;">ST-4989 STRUT MOUNT(Front)</p> <p>LEXUS PASSENGER CAR 2004-06 STRUT MOUNT(Front) (LEFT)</p> <p>LEXUS SPORT UTILITY 2004-06 STRUT MOUNT(Front)</p> <p>TOYOTA PASSENGER CAR 2002-08 TOYOTA SPORT UTILITY 2001-07 TOYOTA VAN 2004-05</p>	 <p style="text-align: center;">ST-4993 STRUT MOUNT(Rear)</p> <p>HONDA PASSENGER CAR 1990-97</p>	 <p style="text-align: center;">ST-4997 STRUT MOUNT(Front) (LEFT)</p> <p>ACURA PASSENGER CAR 2005-06 HONDA PASSENGER CAR 2002-05</p>	 <p style="text-align: center;">ST-5901 STRUT MOUNT(Front)</p> <p>HONDA PASSENGER CAR 1990-97</p>
 <p style="text-align: center;">ST-4990 STRUT MOUNT(Rear)</p> <p>PONTIAC PASSENGER CAR 2003-10 SCION PASSENGER CAR 2005-10 TOYOTA PASSENGER CAR 2000-17</p>	 <p style="text-align: center;">ST-4994 STRUT MOUNT(Rear)</p> <p>MAZDA PASSENGER CAR 1999-03</p>	 <p style="text-align: center;">ST-4998 STRUT MOUNT(Rear) (RIGHT)</p> <p>MAZDA PASSENGER CAR 2000-02</p>	 <p style="text-align: center;">ST-5902 STRUT MOUNT(Front) (RIGHT)</p> <p>DODGE SPORT UTILITY 2007-11 JEEP SPORT UTILITY 2002-12</p>
 <p style="text-align: center;">ST-4991 STRUT MOUNT(Front)</p> <p>TOYOTA PASSENGER CAR 2001-03</p>	 <p style="text-align: center;">ST-4995 STRUT MOUNT(Rear)</p> <p>MAZDA PASSENGER CAR 1999-03</p>	 <p style="text-align: center;">ST-4999 STRUT MOUNT(Rear) (LEFT)</p> <p>MAZDA PASSENGER CAR 2000-02</p>	 <p style="text-align: center;">ST-5903 STRUT MOUNT(Front) (LEFT)</p> <p>DODGE SPORT UTILITY 2007-11 JEEP SPORT UTILITY 2002-12</p>





BUYER'S GUIDE

NUMERICAL LISTING - ILLUSTRATIONS

 <p style="text-align: center;">ST-5904 STRUT MOUNT(Front)</p> <p>HONDA SPORT UTILITY 2009-15 HONDA VAN 2005-17</p>	<p>ST-5908 (Continued)</p> <p>PONTIAC PASSENGER CAR 2005-10 SATURN PASSENGER CAR 2007-09</p>  <p style="text-align: center;">ST-5909 STRUT MOUNT(Front) (LEFT)</p> <p>CHEVROLET PASSENGER CAR 2004-12 PONTIAC PASSENGER CAR 2005-10 SATURN PASSENGER CAR 2007-09</p>	 <p style="text-align: center;">ST-5913 STRUT MOUNT(Front)</p> <p>DODGE TRUCK 2005-09</p>	 <p style="text-align: center;">ST-5918 STRUT MOUNT(Front)</p> <p>FORD PASSENGER CAR 2006-12 LINCOLN PASSENGER CAR 2006-12 MAZDA PASSENGER CAR 2005-08 MERCURY PASSENGER CAR ... 2006-11</p>
 <p style="text-align: center;">ST-5905 STRUT MOUNT(Front)</p> <p>BMW PASSENGER CAR 2003-06</p>	 <p style="text-align: center;">ST-5910 STRUT MOUNT(Front)</p> <p>CADILLAC SPORT UTILITY 2007-14 CHEVROLET SPORT UTILITY 2007-13 CHEVROLET TRUCK 2007-13 GMC SPORT UTILITY 2007-14 GMC TRUCK 2007-14</p>	 <p style="text-align: center;">ST-5914 STRUT MOUNT(Front)</p> <p>DODGE TRUCK 2006-08</p>	 <p style="text-align: center;">ST-5919 STRUT MOUNT(Front)</p> <p>HONDA PASSENGER CAR 1992-95</p>
 <p style="text-align: center;">ST-5906 STRUT MOUNT(Front)</p> <p>CHEVROLET PASSENGER CAR 2004-11 PONTIAC PASSENGER CAR 2005-09 SUZUKI PASSENGER CAR 2004-08</p>	 <p style="text-align: center;">ST-5911 STRUT MOUNT(Front)</p> <p>CHRYSLER SUV 2004-08 CHRYSLER VAN 2001-07 DODGE VAN 2001-07</p>	 <p style="text-align: center;">ST-5915 STRUT MOUNT(Front)</p> <p>FORD PASSENGER CAR 2005-10 MERCURY PASSENGER CAR ... 2005-07</p>	 <p style="text-align: center;">ST-5920 STRUT MOUNT(Front) (UPPER SPR ISO)</p> <p>HONDA PASSENGER CAR 1990-93</p>
 <p style="text-align: center;">ST-5907 STRUT MOUNT(Front)</p> <p>CHEVROLET PASSENGER CAR 2005-11 PONTIAC PASSENGER CAR 2005-09</p>	 <p style="text-align: center;">ST-5912 STRUT MOUNT(Front)</p> <p>CHEVROLET PASSENGER CAR 1998-02 GEO PASSENGER CAR 1989-97 TOYOTA PASSENGER CAR 1988-02</p>	 <p style="text-align: center;">ST-5916 STRUT MOUNT(Front)</p> <p>HYUNDAI PASSENGER CAR 2003-08</p>	 <p style="text-align: center;">ST-5921 STRUT MOUNT(Front) (UPPER SPR SEAT)</p> <p>MERCURY VAN 1993-98</p>
 <p style="text-align: center;">ST-5908 STRUT MOUNT(Front) (RIGHT)</p> <p>CHEVROLET PASSENGER CAR 2004-12</p> <p style="text-align: center;">(Continued Next Column)</p>	 <p style="text-align: center;">ST-5917 STRUT MOUNT(Front)</p> <p>MAZDA PASSENGER CAR 2003-04</p>		

BUYER'S GUIDE

NUMERICAL LISTING - ILLUSTRATIONS

 <p>ST-5922 STRUT MOUNT(Front) JEEP SPORT UTILITY 2005-10</p>	 <p>ST-5927 STRUT MOUNT(Front) KIA SPORT UTILITY 2003-06</p>	 <p>ST-5933 STRUT MOUNT(Front) LEXUS PASSENGER CAR 1995-00</p>	 <p>ST-5937 STRUT MOUNT(Rear) (LEFT) LEXUS SPORT UTILITY 2004-06 TOYOTA SPORT UTILITY 2004-07</p>
 <p>ST-5923 STRUT MOUNT(Front) KIA PASSENGER CAR 2004-06 STRUT MOUNT(Rear) KIA PASSENGER CAR 2004-06</p>	 <p>ST-5929 STRUT MOUNT(Rear) LAND ROVER SPORT UTILITY .. 2002-05</p>	 <p>ST-5934 STRUT MOUNT(Front) LEXUS PASSENGER CAR 2001-06</p>	 <p>ST-5938 STRUT MOUNT(Front) LEXUS PASSENGER CAR 1992-00</p>
 <p>ST-5924 STRUT MOUNT(Front) (LOWER SPR ISO) MERCURY VAN 1993-98</p>	 <p>ST-5930 STRUT MOUNT(Rear) LEXUS PASSENGER CAR 1998-05</p>	 <p>ST-5935 STRUT MOUNT(Rear) LEXUS PASSENGER CAR 2001-06</p>	 <p>ST-5939 STRUT MOUNT(Rear) NISSAN PASSENGER CAR 1995-99</p>
 <p>ST-5925 STRUT MOUNT(Front) (RIGHT) KIA PASSENGER CAR 2001-05</p>	 <p>ST-5931 STRUT MOUNT(Rear) LEXUS PASSENGER CAR 1993-97</p>	 <p>ST-5936 STRUT MOUNT(Rear) (RIGHT) LEXUS SPORT UTILITY 2004-06 TOYOTA SPORT UTILITY 2004-07</p>	 <p>ST-5940 STRUT MOUNT(Rear) LEXUS PASSENGER CAR 2002-08</p>
 <p>ST-5926 STRUT MOUNT(Front) (LEFT) KIA PASSENGER CAR 2001-05</p>	 <p>ST-5932 STRUT MOUNT(Front) LEXUS PASSENGER CAR 2001-05</p>		

BUYER'S GUIDE

NUMERICAL LISTING - ILLUSTRATIONS

 <p style="text-align: center;">ST-5941 STRUT MOUNT(Rear)</p> <p>MITSUBISHI PASSENGER CAR 1992-96</p>	<p>ST-5944 (Continued) MITSUBISHI SPORT UTILITY 2003-06</p>  <p style="text-align: center;">ST-5945 STRUT MOUNT(Rear)</p> <p>MITSUBISHI PASSENGER CAR 2002-07</p>	 <p style="text-align: center;">ST-5948 STRUT MOUNT(Front) (Bushing)</p> <p>SATURN PASSENGER CAR 2003-07</p>	 <p style="text-align: center;">ST-5952 STRUT MOUNT(Rear)</p> <p>SUZUKI PASSENGER CAR 1995-99</p>
 <p style="text-align: center;">ST-5942 STRUT MOUNT(Rear)</p> <p>MITSUBISHI PASSENGER CAR 1997-03</p>	 <p style="text-align: center;">ST-5946 STRUT MOUNT(Front) (UPPER SPR SEAT)</p> <p>VOLKSWAGEN PASSENGER CAR 1993-98</p>	 <p style="text-align: center;">ST-5949 STRUT MOUNT(Front)</p> <p>SATURN SUV 2002-07</p>	 <p style="text-align: center;">ST-5953 STRUT MOUNT(Rear)</p> <p>SUZUKI PASSENGER CAR 2000-07</p>
 <p style="text-align: center;">ST-5943 STRUT MOUNT(Front)</p> <p>MITSUBISHI PASSENGER CAR 2002-06</p>	 <p style="text-align: center;">ST-5947 STRUT MOUNT(Front) (UPPER SPR ISO)</p> <p>TOYOTA PASSENGER CAR 1993-02</p>	 <p style="text-align: center;">ST-5950 STRUT MOUNT(Rear)</p> <p>SUBARU PASSENGER CAR 2004-07 SUBARU SPORT UTILITY 2003-08</p>	 <p style="text-align: center;">ST-5954 STRUT MOUNT(Front) (LOWER SPR ISO)</p> <p>CHRYSLER PASSENGER CAR 1993-97 DODGE PASSENGER CAR 1993-97 EAGLE PASSENGER CAR 1993-97</p>
 <p style="text-align: center;">ST-5944 STRUT MOUNT(Front)</p> <p>MITSUBISHI PASSENGER CAR 2002-07 (Continued Next Column)</p>		 <p style="text-align: center;">ST-5951 STRUT MOUNT(Front)</p> <p>SUZUKI PASSENGER CAR 1995-07</p>	 <p style="text-align: center;">ST-5955 STRUT MOUNT(Rear) (LOWER SPR ISO)</p> <p>CHRYSLER PASSENGER CAR 1993-97 (Continued Next Page)</p>

BUYER'S GUIDE

NUMERICAL LISTING - ILLUSTRATIONS

ST-5955 (Continued)

DODGE PASSENGER CAR 1993-97
 EAGLE PASSENGER CAR 1993-97



ST-5956
STRUT MOUNT(Rear)

HONDA PASSENGER CAR 1992-95



ST-5957
STRUT MOUNT(Front)

TOYOTA PASSENGER CAR 2000-09



ST-5958
STRUT MOUNT(Front)

VOLVO PASSENGER CAR 2000



ST-5959
STRUT MOUNT(Front)

VOLVO PASSENGER CAR 2000-04



ST-5960
STRUT MOUNT(Front) (LOWER SPR ISO)

TOYOTA PASSENGER CAR 1993-02



ST-5961
STRUT MOUNT(Rear) (LOWER SPR ISO)

TOYOTA PASSENGER CAR 1993-02



ST-5962
STRUT MOUNT(Front)

NISSAN PASSENGER CAR 1995-99



ST-5963
STRUT MOUNT(Rear) (UPPER SPR ISO)

VOLKSWAGEN PASSENGER CAR 1993-98



ST-5964
STRUT MOUNT(Rear) (LOWER SPR ISO)

FORD PASSENGER CAR 1996-07
 MERCURY PASSENGER CAR ... 1986-95



ST-5965
STRUT MOUNT(Front) (LOWER SPR ISO)

FORD PASSENGER CAR 1986-95
 MERCURY PASSENGER CAR ... 1986-95



ST-5966
STRUT MOUNT(Front)

CHRYSLER PASSENGER CAR 2005-14
 DODGE PASSENGER CAR 2005-14



ST-5967
STRUT MOUNT(Front) (LEFT)

CHRYSLER PASSENGER CAR 2005-14
 DODGE PASSENGER CAR 2005-14



ST-5968
STRUT MOUNT(Front) (RIGHT)

CHRYSLER PASSENGER CAR 2005-14
 DODGE PASSENGER CAR 2005-14



ST-5969
STRUT MOUNT(Rear)

CHRYSLER PASSENGER CAR 2005-10
 DODGE PASSENGER CAR 2005-10



ST-5970
STRUT MOUNT(Rear) (Bushing)

CHRYSLER PASSENGER CAR 2005-14
 DODGE PASSENGER CAR 2005-14

BUYER'S GUIDE

NUMERICAL LISTING - ILLUSTRATIONS



ST-5971
STRUT MOUNT(Front) (LOWER SPR ISO)

CHRYSLER VAN 2001-07
DODGE VAN 2001-07



ST-5975
STRUT MOUNT(Rear) (LOWER SPR ISO)

HONDA PASSENGER CAR 1994-97



ST-5978
STRUT MOUNT(Front) (UPPER SPR ISO)

NISSAN PASSENGER CAR 1995-99



ST-5981
STRUT MOUNT(Rear)

CHEVROLET PASSENGER CAR 2004-11
PONTIAC PASSENGER CAR 2005-09
SUZUKI PASSENGER CAR 2004-08



ST-5972
STRUT MOUNT(Front) (UPPER SPR ISO)

CHRYSLER VAN 2001-07
DODGE VAN 2001-07



ST-5976
STRUT MOUNT(Front) (UPPER SPR ISO)

HONDA PASSENGER CAR 1992-00



ST-5979
STRUT MOUNT(Rear) (UPPER SPR ISO)

NISSAN PASSENGER CAR 1995-99



ST-5982
STRUT MOUNT(Rear) (LOWER SPR ISO)

CHRYSLER PASSENGER CAR 1998-04
DODGE PASSENGER CAR 1998-04



ST-5973
STRUT MOUNT(Rear) (UPPER SPR ISO)

CHRYSLER PASSENGER CAR 1998-04
DODGE PASSENGER CAR 1998-04



ST-5977
STRUT MOUNT(Rear) (UPPER SPR ISO)

HONDA PASSENGER CAR 1992-00



ST-5980
STRUT MOUNT(Front)

CHEVROLET SPORT UTILITY 2005-06
PONTIAC SPORT UTILITY 2006



ST-5983
STRUT MOUNT(Front)

HYUNDAI PASSENGER CAR 2006-11
KIA PASSENGER CAR 2007-09



ST-5974
STRUT MOUNT(Rear) (UPPER SPR ISO)

HONDA PASSENGER CAR 1994-97

BUYER'S GUIDE

NUMERICAL LISTING - ILLUSTRATIONS

 <p style="text-align: center;">ST-5984 STRUT MOUNT(Rear)</p> <p>HYUNDAI PASSENGER CAR 2006-11 KIA PASSENGER CAR 2007-11</p>	 <p style="text-align: center;">ST-5988 STRUT MOUNT(Front) (LOWER SPR ISO)</p> <p>CHRYSLER PASSENGER CAR 1998-04 DODGE PASSENGER CAR 1998-04</p>	 <p style="text-align: center;">ST-5992 STRUT MOUNT(Front) (LOWER SPR ISO)</p> <p>CHRYSLER PASSENGER CAR 2000-02 DODGE PASSENGER CAR 2000-05</p>	 <p style="text-align: center;">ST-5995 STRUT MOUNT(Rear) (UPPER SPR ISO)</p> <p>NISSAN PASSENGER CAR 1993-99</p>
 <p style="text-align: center;">ST-5985 STRUT MOUNT(Front)</p> <p>NISSAN PASSENGER CAR 2003-08</p>	 <p style="text-align: center;">ST-5989 STRUT MOUNT(Front) (UPPER SPR ISO)</p> <p>CHRYSLER PASSENGER CAR 1998-04 DODGE PASSENGER CAR 1998-04</p>	 <p style="text-align: center;">ST-5993 STRUT MOUNT(Front) (UPPER SPR ISO)</p> <p>HONDA PASSENGER CAR 1998-02</p>	 <p style="text-align: center;">ST-5996 STRUT MOUNT(Front) (LOWER SPR ISO)</p> <p>NISSAN PASSENGER CAR 1991-99</p> <p style="text-align: center;">STRUT MOUNT(Rear) (LOWER SPR ISO)</p> <p>NISSAN PASSENGER CAR 1991-01</p>
 <p style="text-align: center;">ST-5986 STRUT MOUNT(Front)</p> <p>HONDA PASSENGER CAR 1998-02</p>	 <p style="text-align: center;">ST-5990 STRUT MOUNT(Rear)</p> <p>KIA PASSENGER CAR 2001-06</p>	 <p style="text-align: center;">ST-5994 STRUT MOUNT(Rear) (UPPER SPR ISO)</p> <p>HONDA PASSENGER CAR 1998-02</p>	 <p style="text-align: center;">ST-5997 STRUT MOUNT(Front) (LOWER SPR SEAT & ISO)</p> <p>LEXUS PASSENGER CAR 1992-94 TOYOTA PASSENGER CAR 1992-94</p>
 <p style="text-align: center;">ST-5987 STRUT MOUNT(Rear)</p> <p>HONDA PASSENGER CAR 1998-02</p>			

BUYER'S GUIDE

NUMERICAL LISTING - ILLUSTRATIONS

 <p style="text-align: center;">ST-6914 STRUT MOUNT(Front)</p> <table style="width: 100%; border-collapse: collapse;"> <tr><td>INFINITI PASSENGER CAR</td><td>2000-04</td></tr> <tr><td>INFINITI SPORT UTILITY</td><td>2003-08</td></tr> <tr><td>NISSAN PASSENGER CAR</td><td>2000-08</td></tr> <tr><td>NISSAN SPORT UTILITY</td><td>2003-07</td></tr> <tr><td>NISSAN VAN</td><td>2004-09</td></tr> </table>	INFINITI PASSENGER CAR	2000-04	INFINITI SPORT UTILITY	2003-08	NISSAN PASSENGER CAR	2000-08	NISSAN SPORT UTILITY	2003-07	NISSAN VAN	2004-09	 <p style="text-align: center;">ST-6918 STRUT MOUNT(Front)</p> <table style="width: 100%; border-collapse: collapse;"> <tr><td>FORD SPORT UTILITY</td><td>2002-05</td></tr> <tr><td>MERCURY SPORT UTILITY</td><td>2002-05</td></tr> </table>	FORD SPORT UTILITY	2002-05	MERCURY SPORT UTILITY	2002-05	 <p style="text-align: center;">ST-6922 STRUT MOUNT(Front) (UPPER SPR SEAT)</p> <table style="width: 100%; border-collapse: collapse;"> <tr><td>SATURN SUV</td><td>2006-07</td></tr> </table>	SATURN SUV	2006-07	 <p style="text-align: center;">ST-6925 STRUT MOUNT(Rear) (UPPER SPR ISO)</p> <table style="width: 100%; border-collapse: collapse;"> <tr><td>FORD SPORT UTILITY</td><td>2002-05</td></tr> <tr><td>MERCURY SPORT UTILITY</td><td>2002-05</td></tr> </table>	FORD SPORT UTILITY	2002-05	MERCURY SPORT UTILITY	2002-05
INFINITI PASSENGER CAR	2000-04																						
INFINITI SPORT UTILITY	2003-08																						
NISSAN PASSENGER CAR	2000-08																						
NISSAN SPORT UTILITY	2003-07																						
NISSAN VAN	2004-09																						
FORD SPORT UTILITY	2002-05																						
MERCURY SPORT UTILITY	2002-05																						
SATURN SUV	2006-07																						
FORD SPORT UTILITY	2002-05																						
MERCURY SPORT UTILITY	2002-05																						
 <p style="text-align: center;">ST-6915 STRUT MOUNT(Rear) (Lower Bushing)</p> <table style="width: 100%; border-collapse: collapse;"> <tr><td>ACURA PASSENGER CAR</td><td>1986-90</td></tr> <tr><td>HONDA PASSENGER CAR</td><td>1984-93</td></tr> <tr><td>HONDA VAN</td><td>1984-87</td></tr> </table>	ACURA PASSENGER CAR	1986-90	HONDA PASSENGER CAR	1984-93	HONDA VAN	1984-87	 <p style="text-align: center;">ST-6919 STRUT MOUNT(Front) (RIGHT)</p> <table style="width: 100%; border-collapse: collapse;"> <tr><td>ACURA PASSENGER CAR</td><td>2001-06</td></tr> <tr><td>HONDA PASSENGER CAR</td><td>2001-05</td></tr> <tr><td>HONDA SPORT UTILITY</td><td>2002-11</td></tr> </table>	ACURA PASSENGER CAR	2001-06	HONDA PASSENGER CAR	2001-05	HONDA SPORT UTILITY	2002-11	 <p style="text-align: center;">ST-6923 STRUT MOUNT(Front) (UPPER SPR ISO)</p> <table style="width: 100%; border-collapse: collapse;"> <tr><td>FORD SPORT UTILITY</td><td>2002-05</td></tr> <tr><td>MERCURY SPORT UTILITY</td><td>2002-05</td></tr> </table>	FORD SPORT UTILITY	2002-05	MERCURY SPORT UTILITY	2002-05	 <p style="text-align: center;">ST-6926 STRUT MOUNT(Rear) (UPPER SPR ISO)</p> <table style="width: 100%; border-collapse: collapse;"> <tr><td>FORD SPORT UTILITY</td><td>2002-05</td></tr> <tr><td>MERCURY SPORT UTILITY</td><td>2002-05</td></tr> </table>	FORD SPORT UTILITY	2002-05	MERCURY SPORT UTILITY	2002-05
ACURA PASSENGER CAR	1986-90																						
HONDA PASSENGER CAR	1984-93																						
HONDA VAN	1984-87																						
ACURA PASSENGER CAR	2001-06																						
HONDA PASSENGER CAR	2001-05																						
HONDA SPORT UTILITY	2002-11																						
FORD SPORT UTILITY	2002-05																						
MERCURY SPORT UTILITY	2002-05																						
FORD SPORT UTILITY	2002-05																						
MERCURY SPORT UTILITY	2002-05																						
 <p style="text-align: center;">ST-6916 STRUT MOUNT(Rear) (Lower Bushing)</p> <table style="width: 100%; border-collapse: collapse;"> <tr><td>ACURA PASSENGER CAR</td><td>1990-03</td></tr> <tr><td>HONDA PASSENGER CAR</td><td>1989-97</td></tr> </table>	ACURA PASSENGER CAR	1990-03	HONDA PASSENGER CAR	1989-97	 <p style="text-align: center;">ST-6920 STRUT MOUNT(Front) (LEFT)</p> <table style="width: 100%; border-collapse: collapse;"> <tr><td>ACURA PASSENGER CAR</td><td>2001-06</td></tr> <tr><td>HONDA PASSENGER CAR</td><td>2001-05</td></tr> <tr><td>HONDA SPORT UTILITY</td><td>2002-11</td></tr> </table>	ACURA PASSENGER CAR	2001-06	HONDA PASSENGER CAR	2001-05	HONDA SPORT UTILITY	2002-11	 <p style="text-align: center;">ST-6924 STRUT MOUNT(Front) (UPPER SPR SEAT)</p> <table style="width: 100%; border-collapse: collapse;"> <tr><td>FORD SPORT UTILITY</td><td>2002-05</td></tr> <tr><td>MERCURY SPORT UTILITY</td><td>2002-05</td></tr> </table>	FORD SPORT UTILITY	2002-05	MERCURY SPORT UTILITY	2002-05	 <p style="text-align: center;">ST-6927 STRUT MOUNT(Rear)</p> <table style="width: 100%; border-collapse: collapse;"> <tr><td>FORD SPORT UTILITY</td><td>2002-05</td></tr> <tr><td>MERCURY SPORT UTILITY</td><td>2002-05</td></tr> </table>	FORD SPORT UTILITY	2002-05	MERCURY SPORT UTILITY	2002-05		
ACURA PASSENGER CAR	1990-03																						
HONDA PASSENGER CAR	1989-97																						
ACURA PASSENGER CAR	2001-06																						
HONDA PASSENGER CAR	2001-05																						
HONDA SPORT UTILITY	2002-11																						
FORD SPORT UTILITY	2002-05																						
MERCURY SPORT UTILITY	2002-05																						
FORD SPORT UTILITY	2002-05																						
MERCURY SPORT UTILITY	2002-05																						
 <p style="text-align: center;">ST-6917 STRUT MOUNT(Rear)</p> <table style="width: 100%; border-collapse: collapse;"> <tr><td>CHRYSLER PASSENGER CAR</td><td>2001-06</td></tr> <tr><td>DODGE PASSENGER CAR</td><td>2001-06</td></tr> </table>	CHRYSLER PASSENGER CAR	2001-06	DODGE PASSENGER CAR	2001-06	 <p style="text-align: center;">ST-6921 STRUT MOUNT(Front) (UPPER SPR ISO)</p> <table style="width: 100%; border-collapse: collapse;"> <tr><td>SATURN SUV</td><td>2006-07</td></tr> </table>	SATURN SUV	2006-07																
CHRYSLER PASSENGER CAR	2001-06																						
DODGE PASSENGER CAR	2001-06																						
SATURN SUV	2006-07																						

BUYER'S GUIDE

NUMERICAL LISTING - ILLUSTRATIONS

 <p>ST-6928 STRUT MOUNT(Front) (UPPER SPR SEAT) SATURN PASSENGER CAR 1991-02</p>	 <p>ST-6931 STRUT MOUNT(Rear) (UPPER SPR SEAT Right) NISSAN PASSENGER CAR 1993-99</p>	 <p>ST-6935 STRUT MOUNT(Front) (LOWER SPR ISO) LEXUS PASSENGER CAR 2004-09 TOYOTA PASSENGER CAR 2004-11 STRUT MOUNT(Rear) (LOWER SPR ISO) LEXUS PASSENGER CAR 2004-06 TOYOTA PASSENGER CAR 2004-06</p>	 <p>ST-6938 STRUT MOUNT(Front) (LOWER SPR ISO) CHRYSLER PASSENGER CAR 2001-05 DODGE PASSENGER CAR 2001-05 MITSUBISHI PASSENGER CAR 1997-05</p>
 <p>ST-6929 STRUT MOUNT(Front) (UPPER SPR SEAT) NISSAN PASSENGER CAR 1993-99</p>	 <p>ST-6932 STRUT MOUNT(Front) (UPPER SPR SEAT) FORD PASSENGER CAR 2000-05</p>	 <p>ST-6936 STRUT MOUNT(Front) (LOWER SPR ISO) LEXUS PASSENGER CAR 1990-91 PONTIAC PASSENGER CAR 2003-08 TOYOTA PASSENGER CAR 1987-08 STRUT MOUNT(Rear) (LOWER SPR ISO) HYUNDAI PASSENGER CAR 1997-05 SUBARU PASSENGER CAR 2002-03</p>	 <p>ST-6939 STRUT MOUNT(Rear) (LOWER SPR ISO) HYUNDAI PASSENGER CAR 1996-01</p>
 <p>ST-6930 STRUT MOUNT(Rear) (UPPER SPR SEAT Left) NISSAN PASSENGER CAR 1993-99</p>	 <p>ST-6934 STRUT MOUNT(Front) MERCEDES-BENZ PASSENGER CAR 2001-05</p>	 <p>ST-6937 STRUT MOUNT(Front) (LOWER SPR ISO) LEXUS PASSENGER CAR 1992-94 TOYOTA PASSENGER CAR 1992-94</p>	 <p>ST-6940 STRUT MOUNT(Front) (LOWER SPR ISO) MAZDA PASSENGER CAR 1995-98</p>

BUYER'S GUIDE

NUMERICAL LISTING - ILLUSTRATIONS

			
<p>ST-6941 STRUT MOUNT(Front) (LOWER SPR ISO)</p> <p><small>VOLVO PASSENGER CAR 1999-07</small></p>	<p>ST-6944 STRUT MOUNT(Front) (LOWER SPR ISO)</p> <p><small>BMW PASSENGER CAR 1992-00</small></p>	<p>ST-6947 STRUT MOUNT(Front) (LOWER SPR ISO)</p> <p><small>TOYOTA PASSENGER CAR 1995-99</small></p>	<p>ST-6950 STRUT MOUNT(Front) (LOWER SPR ISO)</p> <p><small>ACURA PASSENGER CAR 2004-14 HONDA PASSENGER CAR 2003-07</small></p>
			
<p>ST-6942 STRUT MOUNT(Front) (LOWER SPR ISO)</p> <p><small>MAZDA PASSENGER CAR 1999-03</small></p>	<p>ST-6945 STRUT MOUNT(Front) (LOWER SPR ISO)</p> <p><small>NISSAN PASSENGER CAR 2002-08</small></p>	<p>ST-6948 STRUT MOUNT(Rear) (LOWER SPR ISO)</p> <p><small>HYUNDAI PASSENGER CAR 2001-06</small></p>	<p>ST-6951 STRUT MOUNT(Rear) (LOWER SPR ISO)</p> <p><small>ACURA PASSENGER CAR 2004-08 HONDA PASSENGER CAR 2003-07</small></p>
			
<p>ST-6943 STRUT MOUNT(Front) (LOWER SPR ISO)</p> <p><small>HYUNDAI PASSENGER CAR 1996-01</small></p>	<p>ST-6946 STRUT MOUNT(Front) (LOWER SPR ISO)</p> <p><small>SUBARU PASSENGER CAR 1992-99 SUBARU SPORT UTILITY 1998-02</small></p>	<p>ST-6949 STRUT MOUNT(Rear) (LOWER SPR ISO)</p> <p><small>ACURA PASSENGER CAR 1997-03 HONDA PASSENGER CAR 1998-02</small></p>	<p>ST-6952 STRUT MOUNT(Rear) (LOWER SPR ISO)</p> <p><small>SUBARU PASSENGER CAR 1990-01</small></p>

BUYER'S GUIDE

NUMERICAL LISTING - ILLUSTRATIONS

 <p style="text-align: center;">ST-6953 STRUT MOUNT(Front) (LOWER SPR ISO)</p> <p>BMW PASSENGER CAR 1994-01</p>	 <p style="text-align: center;">ST-6957 STRUT MOUNT(Rear)</p> <p>CHRYSLER PASSENGER CAR 1996-00</p>	 <p style="text-align: center;">ST-6961 STRUT MOUNT(Front) (UPPER SPR SEAT)</p> <p>FORD PASSENGER CAR 2006-12</p>	 <p style="text-align: center;">ST-6964 STRUT MOUNT(Front)</p> <p>ACURA PASSENGER CAR 2006-18 HONDA PASSENGER CAR 2006-11</p>
 <p style="text-align: center;">ST-6955 STRUT MOUNT(Rear)</p> <p>CHRYSLER PASSENGER CAR 2001-06</p>	 <p style="text-align: center;">ST-6958 STRUT MOUNT(Front)</p> <p>CHRYSLER PASSENGER CAR 2007-14 DODGE PASSENGER CAR 2008-14</p>	 <p style="text-align: center;">ST-6962 STRUT MOUNT(Front)</p> <p>FORD PASSENGER CAR 2008-11 FORD SPORT UTILITY 2007-10 LINCOLN SPORT UTILITY 2007-10 MERCURY PASSENGER CAR ... 2008-09</p>	 <p style="text-align: center;">ST-6965 STRUT MOUNT(Front)</p> <p>HONDA PASSENGER CAR 2007-12</p>
 <p style="text-align: center;">ST-6956 STRUT MOUNT(Front)</p> <p>CHEVROLET SPORT UTILITY ... 2007-17 GMC SPORT UTILITY 2010-16 PONTIAC SPORT UTILITY 2007-09 SATURN SUV 2008-10 SUZUKI SPORT UTILITY 2007-09</p>	 <p style="text-align: center;">ST-6959 STRUT MOUNT(Rear) (Bushing)</p> <p>CHRYSLER PASSENGER CAR 2007-14 DODGE PASSENGER CAR 2007-14 JEEP SPORT UTILITY 2007-16</p>	 <p style="text-align: center;">ST-6963 STRUT MOUNT(Front)</p> <p>FORD SPORT UTILITY 2007-18 FORD TRUCK 2009-18</p>	 <p style="text-align: center;">ST-6966 STRUT MOUNT(Front)</p> <p>ACURA SPORT UTILITY 2007-12 HONDA SPORT UTILITY 2007-14</p>
 <p style="text-align: center;">ST-6960 STRUT MOUNT(Front)</p> <p>CHRYSLER VAN 2008-15 DODGE VAN 2008-15 RAM VAN 2012-15 VOLKSWAGEN VAN 2009-12</p>	 <p style="text-align: center;">ST-6967 STRUT MOUNT(Front)</p> <p>HYUNDAI PASSENGER CAR 2007-12</p>		

BUYER'S GUIDE

NUMERICAL LISTING - ILLUSTRATIONS



ST-6968
STRUT MOUNT(Front)

DODGE VAN 2010-13
 HYUNDAI SPORT UTILITY 2007-12
 HYUNDAI VAN 2007-09
 KIA VAN 2006-11



ST-6973
STRUT MOUNT(Front) (LEFT)

KIA PASSENGER CAR 2006-11



ST-6977
STRUT MOUNT(Front)

KIA VAN 2002-05



ST-6983
STRUT MOUNT(Front)

MINI 2002-06



ST-6969
STRUT MOUNT(Front) (RIGHT)

HYUNDAI PASSENGER CAR 2006-11



ST-6974
STRUT MOUNT(Front) (RIGHT)

KIA PASSENGER CAR 2006-11



ST-6980
STRUT MOUNT(Front)

MAZDA PASSENGER CAR 2004-12
 MAZDA VAN 2006-14
 VOLVO PASSENGER CAR 2004-12



ST-6984
STRUT MOUNT(Rear)

MINI 2002-06



ST-6970
STRUT MOUNT(Front) (LEFT)

HYUNDAI PASSENGER CAR 2006-11



ST-6975
STRUT MOUNT(Front) (RIGHT)

KIA PASSENGER CAR 2006-11



ST-6981
SHOCK MOUNT (REAR)

FORD PASSENGER CAR 2012-18
 FORD SPORT UTILITY 2013-18
 LINCOLN SPORT UTILITY 2015-19



ST-6985
STRUT MOUNT(Front)

SAAB PASSENGER CAR 2003-11



ST-6971
STRUT MOUNT(Rear)

HYUNDAI PASSENGER CAR 2006-11
 KIA PASSENGER CAR 2006-11



ST-6976
STRUT MOUNT(Front) (LEFT)

KIA PASSENGER CAR 2006-11



ST-6982
STRUT MOUNT(Front)
STRUT MOUNT(Rear)

MAZDA PASSENGER CAR 2004-12
 MAZDA PASSENGER CAR 2004-12



ST-6986
STRUT MOUNT(Front)

LEXUS PASSENGER CAR 2007-12
 TOYOTA PASSENGER CAR 2006-12
 TOYOTA SPORT UTILITY 2008-13

BUYER'S GUIDE

NUMERICAL LISTING - ILLUSTRATIONS

 <p style="text-align: center;">ST-6987 STRUT MOUNT(Front)</p> <p>SCION PASSENGER CAR 2011-16 TOYOTA PASSENGER CAR 2010-15 TOYOTA SPORT UTILITY 2006-12</p>	 <p style="text-align: center;">ST-6994 STRUT MOUNT(Front) (UPPER SPR SEAT)</p> <p>FORD VAN 2004-07</p>	 <p style="text-align: center;">ST-6998 STRUT MOUNT(Rear) (LEFT)</p> <p>FORD PASSENGER CAR 2005-09 MERCURY PASSENGER CAR ... 2008-09</p>	 <p style="text-align: center;">ST-7902 STRUT MOUNT(Front) (UPPER SPR SEAT)</p> <p>NISSAN PASSENGER CAR 2002-06</p>
 <p style="text-align: center;">ST-6988 STRUT MOUNT(Front)</p> <p>Lexus PASSENGER CAR 2011-17 SCION PASSENGER CAR 2016 SCION VAN 2008-15 TOYOTA SPORT UTILITY 2006-08</p>	 <p style="text-align: center;">ST-6995 STRUT MOUNT(Front) (LOWER SPR ISO)</p> <p>CHRYSLER PASSENGER CAR 2005-14 DODGE PASSENGER CAR 2005-14</p>	 <p style="text-align: center;">ST-6999 STRUT MOUNT(Rear) (RIGHT)</p> <p>FORD PASSENGER CAR 2005-09 MERCURY PASSENGER CAR ... 2008-09</p>	 <p style="text-align: center;">ST-7903 STRUT MOUNT(Front) (UPPER SPR ISO)</p> <p>NISSAN PASSENGER CAR 2002-06</p>
 <p style="text-align: center;">ST-6989 STRUT MOUNT(Front)</p> <p>SCION PASSENGER CAR 2008-14 TOYOTA PASSENGER CAR 2007-13</p>	 <p style="text-align: center;">ST-6996 STRUT MOUNT(Rear) (LEFT)</p> <p>FORD PASSENGER CAR 2005-07 MERCURY PASSENGER CAR ... 2005-07</p>	 <p style="text-align: center;">ST-7900 STRUT MOUNT(Rear) (LEFT)</p> <p>FORD PASSENGER CAR 2005-09 MERCURY PASSENGER CAR ... 2005-09</p>	 <p style="text-align: center;">ST-7904 STRUT MOUNT(Front) (UPPER SPR SEAT)</p> <p>NISSAN PASSENGER CAR 2002-06</p>
 <p style="text-align: center;">ST-6990 STRUT MOUNT(Rear)</p> <p>VOLVO PASSENGER CAR 2000-04</p>	 <p style="text-align: center;">ST-6997 STRUT MOUNT(Rear) (RIGHT)</p> <p>FORD PASSENGER CAR 2005-07 MERCURY PASSENGER CAR ... 2005-07</p>	 <p style="text-align: center;">ST-7901 STRUT MOUNT(Rear) (RIGHT)</p> <p>FORD PASSENGER CAR 2005-09 MERCURY PASSENGER CAR ... 2005-09</p>	

BUYER'S GUIDE

NUMERICAL LISTING - ILLUSTRATIONS

 <p>ST-7905 STRUT MOUNT(Front) (UPPER SPR SEAT)</p> <p>FORD SPORT UTILITY 2001-12 MAZDA SPORT UTILITY 2001-11 MERCURY SPORT UTILITY 2005-11</p>	 <p>ST-7908 STRUT MOUNT(Front) (UPPER SPR SEAT)</p> <p>CHEVROLET PASSENGER CAR 2005-10 PONTIAC PASSENGER CAR 2005-06</p>	 <p>ST-7911 STRUT MOUNT(Rear) (LOWER SPR ISO)</p> <p>CHRYSLER PASSENGER CAR 2001-06 DODGE PASSENGER CAR 2001-06</p>	 <p>ST-7914 STRUT MOUNT(Rear) (UPPER SPR ISO)</p> <p>HONDA PASSENGER CAR 2001-05 HONDA SPORT UTILITY 2002-11</p>	
 <p>ST-7906 STRUT MOUNT(Front) (UPPER SPR ISO)</p> <p>FORD SPORT UTILITY 2001-12 MAZDA SPORT UTILITY 2001-11 MERCURY SPORT UTILITY 2005-11</p>	 <p>ST-7909 STRUT MOUNT(Front) (UPPER SPR ISO)</p> <p>CHEVROLET PASSENGER CAR 2005-10 PONTIAC PASSENGER CAR 2005-06</p>	 <p>ST-7912 STRUT MOUNT(Rear)</p> <p>CHRYSLER PASSENGER CAR 1996-00</p>	 <p>ST-7915 STRUT MOUNT(Rear)</p> <p>HONDA PASSENGER CAR 2001-05</p>	
 <p>ST-7907 STRUT MOUNT(Front) (LOWER SPR ISO)</p> <p>FORD SPORT UTILITY 2001-12 MAZDA SPORT UTILITY 2001-11 MERCURY SPORT UTILITY 2005-11</p>	 <p>ST-7910 STRUT MOUNT(Front) (LOWER SPR ISO)</p> <p>CHEVROLET PASSENGER CAR 2005-10 PONTIAC PASSENGER CAR 2005-06</p>	 <p>ST-7913 STRUT MOUNT(Rear) (UPPER SPR ISO)</p> <p>CHRYSLER PASSENGER CAR 1996-00</p>	 <p>ST-7916 STRUT MOUNT(Front) (UPPER SPR SEAT)</p> <p>HONDA PASSENGER CAR 2001-05</p>	
				 <p>ST-7917 STRUT MOUNT(Front) (UPPER SPR ISO)</p> <p>HONDA PASSENGER CAR 2002-05</p>

BUYER'S GUIDE

NUMERICAL LISTING - ILLUSTRATIONS

 <p>ST-7919 STRUT MOUNT(Front) (UPPER SPR ISO) HONDA VAN 1999-04</p>	 <p>ST-7923 STRUT MOUNT(Front) TOYOTA SPORT UTILITY 2008-17 TOYOTA TRUCK 2007-16</p>	<p>ST-7926 (Continued) TOYOTA TRUCK 2000-06</p>  <p>ST-7927 STRUT MOUNT(Front) TOYOTA TRUCK 1995-04</p>	 <p>ST-7930 STRUT MOUNT(Front) DODGE TRUCK 2009-10</p>
 <p>ST-7920 STRUT MOUNT(Front) (LOWER SPR ISO) HONDA VAN 1999-04</p>	 <p>ST-7924 STRUT MOUNT(Front) (UPPER SPR ISO) TOYOTA TRUCK 2007-16</p>	 <p>ST-7928 STRUT MOUNT(Front) NISSAN SPORT UTILITY 2005-11 NISSAN TRUCK 2005-11</p>	 <p>ST-7931 STRUT MOUNT(Front) (UPPER SPR SEAT) DODGE TRUCK 2009-10</p>
 <p>ST-7921 STRUT MOUNT(Front) TOYOTA TRUCK 2005-15</p>	 <p>ST-7925 STRUT MOUNT(Front) TOYOTA TRUCK 2000-06</p>	 <p>ST-7929 STRUT MOUNT(Front) (UPPER SPR ISO) NISSAN SPORT UTILITY 2005-11 NISSAN TRUCK 2005-11</p>	 <p>ST-7932 STRUT MOUNT(Front) NISSAN SPORT UTILITY 2005-15 NISSAN TRUCK 2004-15</p>
 <p>ST-7922 STRUT MOUNT(Front) TOYOTA SPORT UTILITY 2003-11</p>	 <p>ST-7926 STRUT MOUNT(Front) (UPPER SPR ISO) (Continued Next Column)</p>	 <p>ST-7933 STRUT MOUNT(Front) (UPPER SPR ISO) NISSAN SPORT UTILITY 2005-15 NISSAN TRUCK 2004-15</p>	

BUYER'S GUIDE

NUMERICAL LISTING - ILLUSTRATIONS

 <p style="text-align: center;">ST-7934 STRUT MOUNT(Rear) FORD SPORT UTILITY 2007-18</p>	<p>ST-7937 (Continued) MERCURY SPORT UTILITY 2006-10</p>  <p style="text-align: center;">ST-7938 STRUT MOUNT(Front) (UPPER SPR SEAT) FORD SPORT UTILITY 2006-10 MERCURY SPORT UTILITY 2006-10</p>	 <p style="text-align: center;">ST-7941 STRUT MOUNT(Rear) (UPPER SPR ISO) FORD SPORT UTILITY 2006-10 MERCURY SPORT UTILITY 2006-10</p>	 <p style="text-align: center;">ST-7945 STRUT MOUNT(Front) (UPPER SPR SEAT & ISO) FORD PASSENGER CAR 2003-11 LINCOLN PASSENGER CAR 2003-11 MERCURY PASSENGER CAR ... 2003-11</p>
 <p style="text-align: center;">ST-7935 STRUT MOUNT(Rear) (UPPER SPR SEAT) FORD SPORT UTILITY 2007-18</p>	 <p style="text-align: center;">ST-7939 STRUT MOUNT(Front) (UPPER SPR ISO) FORD SPORT UTILITY 2006-10 MERCURY SPORT UTILITY 2006-10</p>	 <p style="text-align: center;">ST-7942 STRUT MOUNT(Front) (UPPER SPR ISO) CADILLAC SPORT UTILITY 2007-14 CHEVROLET SPORT UTILITY ... 2007-13 CHEVROLET TRUCK 2007-13 GMC SPORT UTILITY 2007-14 GMC TRUCK 2007-14</p>	 <p style="text-align: center;">ST-7946 STRUT MOUNT(Rear) VOLVO PASSENGER CAR 1999-07</p>
 <p style="text-align: center;">ST-7936 STRUT MOUNT(Rear) (UPPER SPR ISO) FORD SPORT UTILITY 2007-18</p>	 <p style="text-align: center;">ST-7940 STRUT MOUNT(Rear) FORD SPORT UTILITY 2006-10 MERCURY SPORT UTILITY 2006-10</p>	 <p style="text-align: center;">ST-7943 STRUT MOUNT(Front) SCION PASSENGER CAR 2005-10</p>	 <p style="text-align: center;">ST-7947 STRUT MOUNT(Rear) AUDI PASSENGER CAR 2006-13 VOLKSWAGEN PASSENGER CAR 2005-19</p>
 <p style="text-align: center;">ST-7937 STRUT MOUNT(Front) FORD SPORT UTILITY 2006-10</p> <p>(Continued Next Column)</p>	 <p style="text-align: center;">ST-7944 STRUT MOUNT(Front) FORD PASSENGER CAR 2003-11 LINCOLN PASSENGER CAR 2003-11 MERCURY PASSENGER CAR ... 2003-11</p>	 <p style="text-align: center;">ST-7948 STRUT MOUNT(Front) (UPPER SPR ISO) FORD PASSENGER CAR 2005-10 FORD SPORT UTILITY 2007-10 LINCOLN SPORT UTILITY 2007-10 MERCURY PASSENGER CAR ... 2005-07</p>	

BUYER'S GUIDE

NUMERICAL LISTING - ILLUSTRATIONS

 <p style="text-align: center;">ST-7949 STRUT MOUNT(Front)</p> <p>AUDI PASSENGER CAR 2006-15 VOLKSWAGEN PASSENGER CAR 2005-19</p>	 <p style="text-align: center;">ST-7953 STRUT MOUNT(Front) (LOWER SPR ISO)</p> <p>HYUNDAI PASSENGER CAR 2007-12 KIA PASSENGER CAR 2006-11</p>	 <p style="text-align: center;">ST-7957 STRUT MOUNT(Front) (LOWER SPR ISO)</p> <p>ACURA PASSENGER CAR 2006-11 HONDA PASSENGER CAR 2006-15</p>	 <p style="text-align: center;">ST-7961 STRUT MOUNT(Rear) (LOWER SPR ISO)</p> <p>LEXUS PASSENGER CAR 1993-97</p>
 <p style="text-align: center;">ST-7950 STRUT MOUNT(Front) (LOWER SPR ISO)</p> <p>HYUNDAI PASSENGER CAR 2006-11 KIA PASSENGER CAR 2006-11</p>	 <p style="text-align: center;">ST-7954 STRUT MOUNT(Front) (LOWER SPR ISO)</p> <p>KIA VAN 2002-05</p>	 <p style="text-align: center;">ST-7958 STRUT MOUNT(Front) (LOWER SPR ISO)</p> <p>ACURA PASSENGER CAR 1995-04</p>	 <p style="text-align: center;">ST-7962 STRUT MOUNT(Rear) (LOWER SPR ISO)</p> <p>MITSUBISHI PASSENGER CAR 2002-07</p>
 <p style="text-align: center;">ST-7951 STRUT MOUNT(Front) (LOWER SPR ISO)</p> <p>KIA PASSENGER CAR 2005-09 STRUT MOUNT(Rear) (LOWER SPR ISO)</p> <p>KIA PASSENGER CAR 2004-09</p>	 <p style="text-align: center;">ST-7955 STRUT MOUNT(Front) (LOWER SPR ISO RIGHT)</p> <p>HONDA PASSENGER CAR 2006-15</p>	 <p style="text-align: center;">ST-7959 STRUT MOUNT (Rear) (LOWER SPR ISO LEFT)</p> <p>LEXUS PASSENGER CAR 2007-12 TOYOTA PASSENGER CAR 2006-12</p>	 <p style="text-align: center;">ST-7963 STRUT MOUNT(Front) (LOWER SPR ISO)</p> <p>MITSUBISHI PASSENGER CAR 2002-06</p>
 <p style="text-align: center;">ST-7952 STRUT MOUNT(Front) (LOWER SPR ISO)</p> <p>HYUNDAI SPORT UTILITY 2007-09</p>	 <p style="text-align: center;">ST-7956 STRUT MOUNT(Front) (LOWER SPR ISO LEFT)</p> <p>HONDA PASSENGER CAR 2006-15</p>	 <p style="text-align: center;">ST-7960 STRUT MOUNT (Rear) (LOWER SPR ISO RIGHT)</p> <p>LEXUS PASSENGER CAR 2007-12 TOYOTA PASSENGER CAR 2006-12</p>	 <p style="text-align: center;">ST-7964 STRUT MOUNT(Front) (LOWER SPR ISO)</p> <p>MITSUBISHI PASSENGER CAR 2002-05 MITSUBISHI SPORT UTILITY 2003-06</p>

BUYER'S GUIDE

NUMERICAL LISTING - ILLUSTRATIONS

 <p>ST-7965 STRUT MOUNT(Front) (LOWER SPR ISO) MITSUBISHI PASSENGER CAR 2004-12</p>	 <p>ST-7969 STRUT MOUNT(Rear) (LOWER SPR ISO) MINI 2002-06</p>	 <p>ST-7976 STRUT MOUNT(Front) HONDA PASSENGER CAR 2003-07</p>	 <p>ST-7980 STRUT MOUNT(Front) (UPPER SPR ISO) INFINITI SPORT UTILITY 1999-01 NISSAN SPORT UTILITY 1999-01</p>
 <p>ST-7966 STRUT MOUNT(Front) (LOWER SPR ISO) MITSUBISHI PASSENGER CAR 2008-17</p>	 <p>ST-7973 STRUT MOUNT(Front) (UPPER SPR SEAT) BMW PASSENGER CAR 2001-06</p>	 <p>ST-7977 STRUT MOUNT(Front) (UPPER SPR ISO) HONDA PASSENGER CAR 2003-07</p>	 <p>ST-7981 STRUT MOUNT(Front) (UPPER SPR SEAT) PONTIAC PASSENGER CAR 2003-08 TOYOTA PASSENGER CAR 2003-08</p>
 <p>ST-7967 STRUT MOUNT(Front) (LOWER SPR ISO) BMW PASSENGER CAR 2007-13</p>	 <p>ST-7974 STRUT MOUNT(Front) (UPPER SPR ISO) BMW PASSENGER CAR 2001-06</p>	 <p>ST-7978 STRUT MOUNT(Front) INFINITI SPORT UTILITY 1999-01 NISSAN SPORT UTILITY 1999-01</p>	 <p>ST-7982 STRUT MOUNT(Front) (UPPER SPR ISO) PONTIAC PASSENGER CAR 2003-08 TOYOTA PASSENGER CAR 2003-08</p>
 <p>ST-7968 STRUT MOUNT(Rear) (LOWER SPR ISO) ACURA PASSENGER CAR 1996-04</p>	 <p>ST-7975 STRUT MOUNT(Front) (LOWER SPR ISO) BMW PASSENGER CAR 2001-06</p>	 <p>ST-7979 STRUT MOUNT(Front) (UPPER SPR SEAT) INFINITI SPORT UTILITY 1999-01 NISSAN SPORT UTILITY 1999-01</p>	 <p>ST-7983 STRUT MOUNT(Front) ACURA SPORT UTILITY 2007-13 HONDA TRUCK 2006-14</p>

BUYER'S GUIDE

NUMERICAL LISTING - ILLUSTRATIONS

 <p style="text-align: center;">ST-7984 STRUT MOUNT(Front) (Upper Bushing)</p> <p>BMW PASSENGER CAR 2007-13</p>	 <p style="text-align: center;">ST-7988 SHOCK MOUNT (REAR) (LEFT UPPER)</p> <p>BUICK PASSENGER CAR 2010-16 CHEVROLET PASSENGER CAR 2016 SAAB PASSENGER CAR 2010-11</p>	 <p style="text-align: center;">ST-7991 STRUT MOUNT(Front)</p> <p>BUICK PASSENGER CAR 2011-12 CHEVROLET PASSENGER CAR 2010-13</p>	 <p style="text-align: center;">ST-7994 STRUT MOUNT(Front)</p> <p>DODGE PASSENGER CAR 2007-12 JEEP SPORT UTILITY 2007-16</p>
 <p style="text-align: center;">ST-7985 SHOCK MOUNT (REAR)</p> <p>BMW PASSENGER CAR 2007-13 BMW SPORT UTILITY 2013-15</p>	 <p style="text-align: center;">ST-7989 SHOCK MOUNT (REAR) (RIGHT UPPER)</p> <p>BUICK PASSENGER CAR 2010-16 CHEVROLET PASSENGER CAR 2016 SAAB PASSENGER CAR 2010-11</p>	 <p style="text-align: center;">ST-7992 STRUT MOUNT(Rear)</p> <p>CHEVROLET PASSENGER CAR 2010-13</p>	 <p style="text-align: center;">ST-7995 STRUT MOUNT(Rear) (Bushing)</p> <p>DODGE SPORT UTILITY 2009-15</p>
 <p style="text-align: center;">ST-7986 STRUT MOUNT(Front)</p> <p>BUICK SPORT UTILITY 2008-16 CHEVROLET SPORT UTILITY 2009-16 GMC SPORT UTILITY 2007-16 SATURN SUV 2007-10</p>	 <p style="text-align: center;">ST-7990 STRUT MOUNT(Rear)</p> <p>CHEVROLET PASSENGER CAR 2004-12 PONTIAC PASSENGER CAR 2005-10 SATURN PASSENGER CAR 2007-09</p>	 <p style="text-align: center;">ST-7993 STRUT MOUNT(Rear) (UPPER SPR ISO)</p> <p>CHRYSLER PASSENGER CAR 1995-06 DODGE PASSENGER CAR 1995-06 EAGLE PASSENGER CAR 1995-98 MITSUBISHI PASSENGER CAR 1994-99</p>	 <p style="text-align: center;">ST-7996 STRUT MOUNT(Front)</p> <p>FORD PASSENGER CAR 2011-18 FORD SPORT UTILITY 2013-16 MAZDA PASSENGER CAR 2011-16</p>
 <p style="text-align: center;">ST-7987 STRUT MOUNT(Front)</p> <p>BUICK PASSENGER CAR 2010-17 CHEVROLET PASSENGER CAR 2013-20</p>	 <p style="text-align: center;">ST-7997 STRUT MOUNT(Rear)</p> <p>FORD PASSENGER CAR 2011-18 MAZDA PASSENGER CAR 2011-16</p>		

BUYER'S GUIDE

NUMERICAL LISTING - ILLUSTRATIONS

 <p style="text-align: center;">ST-7998 STRUT MOUNT(Rear) (UPPER SPR ISO)</p> <p>FORD PASSENGER CAR 2005-09 MERCURY PASSENGER CAR ... 2005-09</p>	 <p style="text-align: center;">ST-8904 STRUT MOUNT(Rear) (LEFT)</p> <p>KIA PASSENGER CAR 2001-04</p>	 <p style="text-align: center;">ST-8909 STRUT MOUNT(Rear)</p> <p>MAZDA PASSENGER CAR 1995</p>	 <p style="text-align: center;">ST-8913 STRUT MOUNT(Front)</p> <p>NISSAN PASSENGER CAR 2007-14</p>
 <p style="text-align: center;">ST-7999 STRUT MOUNT(Front) (LOWER SPR ISO)</p> <p>FORD PASSENGER CAR 2008-11 LINCOLN PASSENGER CAR 2010-11 LINCOLN SPORT UTILITY 2010-11 MERCURY PASSENGER CAR ... 2008-09</p>	 <p style="text-align: center;">ST-8905 STRUT MOUNT(Rear) (RIGHT)</p> <p>KIA PASSENGER CAR 2001-04</p>	 <p style="text-align: center;">ST-8910 STRUT MOUNT(Front)</p> <p>MINI 2007-17</p>	 <p style="text-align: center;">ST-8914 STRUT MOUNT(Front) (LEFT)</p> <p>CHEVROLET VAN 2015-18 NISSAN PASSENGER CAR 2007-12</p>
 <p style="text-align: center;">ST-8900 STRUT MOUNT(Front)</p> <p>FORD VAN 2010-13</p>	 <p style="text-align: center;">ST-8907 STRUT MOUNT(Front)</p> <p>MAZDA SPORT UTILITY 2007-14</p>	 <p style="text-align: center;">ST-8911 STRUT MOUNT(Rear)</p> <p>BMW SPORT UTILITY 2016-18 MINI 2007-18</p>	 <p style="text-align: center;">ST-8915 STRUT MOUNT(Front) (RIGHT)</p> <p>CHEVROLET VAN 2015-18 NISSAN PASSENGER CAR 2007-12</p>
 <p style="text-align: center;">ST-8903 STRUT MOUNT(Front)</p> <p>KIA PASSENGER CAR 2001-04</p>	 <p style="text-align: center;">ST-8908 STRUT MOUNT(Rear)</p> <p>MAZDA PASSENGER CAR 1997-00</p>	 <p style="text-align: center;">ST-8912 STRUT MOUNT(Front)</p> <p>MITSUBISHI PASSENGER CAR 2008-17 MITSUBISHI SPORT UTILITY 2007-19</p>	 <p style="text-align: center;">ST-8916 STRUT MOUNT(Front) (LEFT)</p> <p>NISSAN PASSENGER CAR 2007-18 NISSAN SPORT UTILITY 2008-12</p>

BUYER'S GUIDE

NUMERICAL LISTING - ILLUSTRATIONS

 <p>ST-8917 STRUT MOUNT(Front) (RIGHT) NISSAN PASSENGER CAR 2007-18 NISSAN SPORT UTILITY 2008-12</p>	 <p>ST-8921 STRUT MOUNT(Rear) (LEFT) TOYOTA SPORT UTILITY 2008-13</p>	 <p>ST-8925 SHOCK MOUNT (REAR) (RIGHT UPPER) BUICK PASSENGER CAR 2011-16 CHEVROLET PASSENGER CAR 2013-20</p>	 <p>ST-8929 STRUT MOUNT(Front) (UPPER SPR SEAT) HYUNDAI PASSENGER CAR 2000-05</p>
 <p>ST-8918 STRUT MOUNT(Rear) SUBARU SPORT UTILITY 2006-14</p>	 <p>ST-8922 STRUT MOUNT(Rear) TOYOTA PASSENGER CAR 2000-05</p>	 <p>ST-8926 STRUT MOUNT(Front) SUBARU PASSENGER CAR 2005-13 SUBARU SPORT UTILITY 2005-13</p>	 <p>ST-8930 STRUT MOUNT(Front) (UPPER SPR ISO) HYUNDAI PASSENGER CAR 2000-05</p>
 <p>ST-8919 STRUT MOUNT(Front) SUZUKI SPORT UTILITY 2006-13</p>	 <p>ST-8923 STRUT MOUNT(Rear) AUDI PASSENGER CAR 2008-15 VOLKSWAGEN PASSENGER CAR 2009-15</p>	 <p>ST-8927 STRUT BUMPER(Front) CHRYSLER PASSENGER CAR 1998-04 DODGE PASSENGER CAR 1998-04</p>	 <p>ST-8931 STRUT MOUNT(Front) (UPPER SPR SEAT) HYUNDAI PASSENGER CAR 1997-06 KIA PASSENGER CAR 2005-09</p>
 <p>ST-8920 STRUT MOUNT(Rear) (RIGHT) TOYOTA SPORT UTILITY 2008-13</p>	 <p>ST-8924 STRUT MOUNT(Rear) (LEFT) BUICK PASSENGER CAR 2011-17 SHOCK MOUNT (REAR) (LEFT UPPER) CHEVROLET PASSENGER CAR 2013-20</p>	 <p>ST-8928 STRUT MOUNT SPACER(Front) FORD VAN 1995-03</p>	 <p>ST-8932 STRUT MOUNT(Front) (UPPER SPR ISO) HYUNDAI PASSENGER CAR 2001-06</p>

BUYER'S GUIDE

NUMERICAL LISTING - ILLUSTRATIONS

 <p>ST-8933 STRUT MOUNT(Front) (UPPER SPR SEAT) MAZDA PASSENGER CAR 1999-03</p>	 <p>ST-8939 STRUT MOUNT(Rear) HYUNDAI PASSENGER CAR 1997-05</p>	 <p>ST-8944 STRUT MOUNT(Front) MITSUBISHI PASSENGER CAR 2004-12 MITSUBISHI SPORT UTILITY 2004-11</p>	 <p>ST-8950 STRUT MOUNT(Rear) (UPPER SPR ISO) HYUNDAI PASSENGER CAR 1996-06</p>
 <p>ST-8934 STRUT MOUNT(Front) (UPPER SPR ISO) MAZDA PASSENGER CAR 1999-03</p>	 <p>ST-8941 STRUT MOUNT WASHER(Front Upper) VOLVO PASSENGER CAR 1993-07 VOLVO SPORT UTILITY 2003-07</p>	 <p>ST-8946 STRUT MOUNT(Front) SUZUKI PASSENGER CAR 2004-08</p>	 <p>ST-8951 STRUT BUMPER(Rear Lower) MAZDA PASSENGER CAR 1999-03</p>
 <p>ST-8937 STRUT MOUNT(Front) (UPPER SPR SEAT) HYUNDAI SPORT UTILITY 2005-10 KIA SPORT UTILITY 2005-10</p>	 <p>ST-8942 STRUT MOUNT(Front) PONTIAC PASSENGER CAR 2009-10 TOYOTA PASSENGER CAR 2009-17</p>	 <p>ST-8947 STRUT MOUNT(Rear) SUZUKI PASSENGER CAR 2004-08</p> <p>ST-8948 STRUT MOUNT(Front) BUICK PASSENGER CAR 2006-11 CADILLAC PASSENGER CAR 2006-11</p>	 <p>ST-8952 STRUT MOUNT(Front) (UPPER SPR SEAT) SATURN PASSENGER CAR 2003-07</p>
 <p>ST-8938 STRUT MOUNT(Front) (UPPER SPR ISO) HYUNDAI SPORT UTILITY 2005-10 KIA SPORT UTILITY 2005-10</p>	 <p>ST-8943 STRUT MOUNT(Rear) (UPPER SPR ISO) CHRYSLER PASSENGER CAR 2007-14 DODGE PASSENGER CAR 2008-14 DODGE SPORT UTILITY 2009-15 JEEP SPORT UTILITY 2007-16</p>	 <p>ST-8949 STRUT MOUNT(Front) (LOWER SPR ISO) JEEP SPORT UTILITY 2005-10</p>	 <p>ST-8953 STRUT MOUNT(Front) SATURN PASSENGER CAR 2003-07</p>

BUYER'S GUIDE

NUMERICAL LISTING - ILLUSTRATIONS

 <p style="text-align: center;">ST-8954 STRUT MOUNT(Front) (UPPER SPR ISO)</p> <p>CHEVROLET SPORT UTILITY 2005-06 PONTIAC SPORT UTILITY 2006</p>	 <p style="text-align: center;">ST-8958 STRUT MOUNT(Front) (LOWER SPR ISO)</p> <p>CHRYSLER SUV 2004-08</p>	 <p style="text-align: center;">ST-8962 CONTROL ARM BUSHING (Front)</p> <p>DODGE TRUCK 2009-10 RAM TRUCK 2011-18</p>	 <p style="text-align: center;">ST-8968 STRUT MOUNT(Front)</p> <p>FORD PASSENGER CAR 2008-11</p>
 <p style="text-align: center;">ST-8955 STRUT MOUNT(Front) (UPPER SPR SEAT)</p> <p>INFINITI PASSENGER CAR 2000-04 NISSAN PASSENGER CAR 2000-03</p>	 <p style="text-align: center;">ST-8959 STRUT MOUNT(Front) (UPPER SPR SEAT)</p> <p>CHRYSLER SUV 2004-08</p>	 <p style="text-align: center;">ST-8965 STRUT MOUNT(Rear) (RIGHT)</p> <p>LEXUS PASSENGER CAR 2007-12 TOYOTA PASSENGER CAR 2006-12</p>	 <p style="text-align: center;">ST-8969 STRUT MOUNT(Front) (UPPER SPR SEAT)</p> <p>DODGE PASSENGER CAR 2007-12</p>
 <p style="text-align: center;">ST-8956 STRUT MOUNT(Front)</p> <p>INFINITI PASSENGER CAR 2000-04 NISSAN PASSENGER CAR 2000-03</p>	 <p style="text-align: center;">ST-8960 STRUT MOUNT(Front) (UPPER SPR ISO)</p> <p>CHRYSLER SUV 2004-08</p>	 <p style="text-align: center;">ST-8966 STRUT MOUNT(Rear) (LEFT)</p> <p>LEXUS PASSENGER CAR 2007-12 TOYOTA PASSENGER CAR 2006-12</p>	 <p style="text-align: center;">ST-8970 STRUT MOUNT(Front) (UPPER SPR ISO)</p> <p>DODGE PASSENGER CAR 2007-12</p>
 <p style="text-align: center;">ST-8957 STRUT MOUNT(Front) (UPPER SPR ISO)</p> <p>INFINITI PASSENGER CAR 2000-04 NISSAN PASSENGER CAR 2000-03</p>	 <p style="text-align: center;">ST-8961 STRUT MOUNT(Front)</p> <p>FORD PASSENGER CAR 2012-18 FORD SPORT UTILITY 2013-18 FORD VAN 2014-19 LINCOLN SPORT UTILITY 2015-19</p>	 <p style="text-align: center;">ST-8967 STRUT MOUNT(Front)</p> <p>JAGUAR 2002-08</p>	 <p style="text-align: center;">ST-8971 STRUT MOUNT(Front) (LOWER SPR ISO)</p> <p>DODGE PASSENGER CAR 2007-12 DODGE SPORT UTILITY 2009-15 DODGE VAN 2008-12</p>

BUYER'S GUIDE

NUMERICAL LISTING - ILLUSTRATIONS

 <p>ST-8972 STRUT MOUNT(Rear)</p> <p>CHRYSLER PASSENGER CAR 2007-14 DODGE PASSENGER CAR 2007-14 DODGE SPORT UTILITY 2009-15 JEEP SPORT UTILITY 2007-16</p>	 <p>ST-8977 STRUT MOUNT WASHER (Front Lower)</p> <p>HYUNDAI PASSENGER CAR 2000-05</p>	 <p>ST-8981 STRUT MOUNT(Front) (LOWER SPR ISO)</p> <p>HYUNDAI SPORT UTILITY 2001-06</p>	 <p>ST-8988 STRUT MOUNT(Rear) (RIGHT)</p> <p>TOYOTA PASSENGER CAR 2003-08</p>
 <p>ST-8973 STRUT MOUNT(Rear) (UPPER SPR ISO)</p> <p>DODGE PASSENGER CAR 2007-12</p>	 <p>ST-8978 STRUT MOUNT(Front) (UPPER SPR ISO)</p> <p>HYUNDAI PASSENGER CAR 2000-05</p>	 <p>ST-8982 STRUT MOUNT(Front) (UPPER SPR ISO)</p> <p>DODGE VAN 2008-12</p>	 <p>ST-8989 STRUT MOUNT(Rear) (LEFT)</p> <p>TOYOTA PASSENGER CAR 2003-08</p>
 <p>ST-8975 STRUT MOUNT(Front) (UPPER SPR ISO)</p> <p>NISSAN SPORT UTILITY 2003-07</p>	 <p>ST-8979 STRUT MOUNT(Front) (UPPER SPR SEAT)</p> <p>HYUNDAI SPORT UTILITY 2001-06</p>	 <p>ST-8983 STRUT MOUNT(Front) (UPPER SPR ISO)</p> <p>DODGE SPORT UTILITY 2009-15</p>	 <p>ST-8990 STRUT MOUNT(Rear) (UPPER SPR ISO)</p> <p>TOYOTA PASSENGER CAR 2009-13</p>
 <p>ST-8976 STRUT MOUNT(Front)</p> <p>HYUNDAI PASSENGER CAR 2000-05</p>	 <p>ST-8980 STRUT MOUNT(Front) (UPPER SPR ISO)</p> <p>HYUNDAI SPORT UTILITY 2001-06</p>	 <p>ST-8984 STRUT MOUNT(Front)</p> <p>DODGE SPORT UTILITY 2009-15</p>	 <p>ST-8991 STRUT MOUNT(Rear)</p> <p>CADILLAC PASSENGER CAR 2003</p>

BUYER'S GUIDE

NUMERICAL LISTING - ILLUSTRATIONS

 <p>ST-8992 STRUT MOUNT(Rear) BMW SPORT UTILITY 2004-10</p>	<p>ST-8998 STRUT MOUNT(Front) NISSAN SPORT UTILITY 2009-14 NISSAN VAN 2011-14</p> 	 <p>ST-98003 STRUT MOUNT(Front) CHEVROLET PASSENGER CAR 1994-12</p>	 <p>ST-9902 STRUT MOUNT WASHER (Front Lower) HYUNDAI PASSENGER CAR 2006-10</p>
 <p>ST-8993 SHOCK MOUNT (REAR) BUICK PASSENGER CAR 2012-19 CADILLAC PASSENGER CAR 2014-16 CHEVROLET PASSENGER CAR 2011-16</p>	<p>ST-8999 STRUT MOUNT(Rear) DODGE SPORT UTILITY 2011-15 JEEP SPORT UTILITY 2011-13</p> 	 <p>ST-98004 STRUT MOUNT(Front) DODGE PASSENGER CAR 2005-10</p>	 <p>ST-9903 STRUT MOUNT(Front) (UPPER SPR ISO) MAZDA PASSENGER CAR 2003-04</p>
 <p>ST-8994 STRUT MOUNT(Front) MAZDA PASSENGER CAR 2009-13</p>	<p>ST-98000 STRUT MOUNT(Front) FORD PASSENGER CAR 1998-07</p> 	 <p>ST-98005 STRUT MOUNT(Front) CHEVROLET PASSENGER CAR 2000-08 CHEVROLET TRUCK 2004-11 CHEVROLET VAN 2002-06</p>	 <p>ST-9904 STRUT MOUNT(Front) (LOWER SPR ISO) NISSAN PASSENGER CAR 2007-13</p>
 <p>ST-8997 STRUT MOUNT(Front) HYUNDAI PASSENGER CAR 2011-19 KIA PASSENGER CAR 2011-17</p>	<p>ST-98001 STRUT MOUNT(Front) FORD PASSENGER CAR 2003-10 FORD SPORT UTILITY 2004-12</p> <p>ST-98002 STRUT MOUNT(Front) NISSAN PASSENGER CAR 2002-10 RENAULT PASSENGER CAR 2002-10 RENAULT VAN 2007-09</p>	 <p>ST-9901 STRUT MOUNT(Front) (LOWER SPR ISO) BUICK PASSENGER CAR 2006-11 CADILLAC PASSENGER CAR 2006-11</p>	 <p>ST-9905 STRUT MOUNT(Front) FORD SPORT UTILITY 2011-13</p>

BUYER'S GUIDE

NUMERICAL LISTING - ILLUSTRATIONS



ST-9906
STRUT MOUNT(Front)

FORD PASSENGER CAR 2011-14
 FORD SPORT UTILITY 2011-15
 LINCOLN SPORT UTILITY 2011-15



ST-9910
STRUT MOUNT(Rear) (LEFT)

CADILLAC PASSENGER CAR 2013-16



ST-9914
STRUT MOUNT(Front) (UPPER SPR ISO)

FORD PASSENGER CAR 2008-11
 FORD SPORT UTILITY 2009
 LINCOLN PASSENGER CAR 2010-11
 LINCOLN SPORT UTILITY 2010-11
 MERCURY PASSENGER CAR ... 2008-09



ST-9917
STRUT MOUNT(Front) (LEFT)

ACURA PASSENGER CAR 2009-14
 HONDA PASSENGER CAR 2008-15



ST-9907
STRUT MOUNT(Rear)

AUDI PASSENGER CAR 1997-04



ST-9911
STRUT MOUNT(Rear) (RIGHT)

CADILLAC PASSENGER CAR 2013-16



ST-9915
STRUT MOUNT(Front)

FORD PASSENGER CAR 2012
 FORD SPORT UTILITY 2012
 LINCOLN PASSENGER CAR 2012
 LINCOLN SPORT UTILITY 2012



ST-9918
STRUT MOUNT(Front) (RIGHT)

ACURA PASSENGER CAR 2009-14
 HONDA PASSENGER CAR 2008-15



ST-9908
STRUT MOUNT(Rear)

BMW PASSENGER CAR 2004-17



ST-9912
STRUT MOUNT(Rear)

ACURA PASSENGER CAR 2015-17
 HONDA PASSENGER CAR 2013-14



ST-9916
STRUT MOUNT(Front)

FORD PASSENGER CAR 2013-19
 FORD SPORT UTILITY 2013-19
 LINCOLN PASSENGER CAR 2013-16
 LINCOLN SPORT UTILITY 2013-19



ST-9920
STRUT MOUNT(Rear)

HONDA SPORT UTILITY 2003-11



ST-9909
STRUT MOUNT(Front)

CADILLAC PASSENGER CAR 2013-16



ST-9913
STRUT MOUNT(Front)

TOYOTA TRUCK 2005-13



ST-9921
STRUT MOUNT(Front) (UPPER SPR SEAT)

CHEVROLET TRUCK 2004-12
 GMC TRUCK 2004-12

BUYER'S GUIDE

NUMERICAL LISTING - ILLUSTRATIONS

 <p style="text-align: center;">ST-9922 STRUT MOUNT(Front) (UPPER SPR ISO)</p> <p>ACURA PASSENGER CAR 2009-14 HONDA PASSENGER CAR 2008-15</p>	 <p style="text-align: center;">ST-9925 STRUT MOUNT(Front) (LOWER SPR ISO)</p> <p>CHEVROLET VAN 2015-18 NISSAN PASSENGER CAR 2007-12</p>	 <p style="text-align: center;">ST-9930 STRUT MOUNT(Front) (UPPER SPR ISO)</p> <p>HONDA SPORT UTILITY 2003-11</p>	 <p style="text-align: center;">ST-9938 STRUT MOUNT(Front) (UPPER SPR ISO)</p> <p>HYUNDAI PASSENGER CAR 2006-11 KIA PASSENGER CAR 2006-11</p>
 <p style="text-align: center;">ST-9923 STRUT MOUNT(Front) (UPPER SPR ISO)</p> <p>BUICK SPORT UTILITY 2008-16 CHEVROLET SPORT UTILITY 2009-16 GMC SPORT UTILITY 2007-16 SATURN SUV 2007-10</p>	 <p style="text-align: center;">ST-9927 STRUT MOUNT(Front) (UPPER SPR SEAT)</p> <p>HONDA SPORT UTILITY 2003-11</p>	 <p style="text-align: center;">ST-9931 STRUT MOUNT(Front) (UPPER SPR ISO)</p> <p>LEXUS PASSENGER CAR 2010-12 SCION PASSENGER CAR 2005-10 TOYOTA PASSENGER CAR 2010-15 TOYOTA SPORT UTILITY 2009-12</p>	 <p style="text-align: center;">ST-9939 STRUT MOUNT(Front) (UPPER SPR SEAT)</p> <p>TOYOTA SPORT UTILITY 1996-05</p>
 <p style="text-align: center;">ST-9924 STRUT MOUNT(Front) (LOWER SPR ISO)</p> <p>BUICK SPORT UTILITY 2008-16 CHEVROLET SPORT UTILITY 2009-16 GMC SPORT UTILITY 2007-16 SATURN SUV 2007-10</p>	 <p style="text-align: center;">ST-9929 STRUT MOUNT(Front) (LOWER SPR ISO)</p> <p>FORD PASSENGER CAR 2006-12 LINCOLN PASSENGER CAR 2007-12 MAZDA PASSENGER CAR 2005-08 MERCURY PASSENGER CAR 2006-11</p>	 <p style="text-align: center;">ST-9937 STRUT MOUNT(Front) (UPPER SPR SEAT)</p> <p>HYUNDAI PASSENGER CAR 2006-11 KIA PASSENGER CAR 2006-11</p>	 <p style="text-align: center;">ST-9940 STRUT MOUNT(Front) (UPPER SPR ISO)</p> <p>TOYOTA SPORT UTILITY 1996-05</p>
			 <p style="text-align: center;">ST-9942 STRUT MOUNT(Front) (UPPER SPR SEAT)</p> <p>LEXUS PASSENGER CAR 2013-15 LEXUS SPORT UTILITY 2004-15 TOYOTA SPORT UTILITY 2004-13</p>

BUYER'S GUIDE

NUMERICAL LISTING - ILLUSTRATIONS

			
<p>ST-9943 STRUT MOUNT(Front) (UPPER SPR ISO)</p> <p>LEXUS SPORT UTILITY 2004-15 TOYOTA SPORT UTILITY 2004-13</p>	<p>ST-9948 STRUT MOUNT(Front) (UPPER SPR SEAT)</p> <p>HYUNDAI PASSENGER CAR 2007-12</p>	<p>ST-9957 STRUT MOUNT(Front) (LOWER SPR ISO)</p> <p>TOYOTA PASSENGER CAR 2009-13</p>	<p>ST-9969 (Continued) MITSUBISHI PASSENGER CAR 1999-05</p>
			
<p>ST-9945 STRUT MOUNT(Front) (UPPER SPR ISO)</p> <p>HONDA PASSENGER CAR 2006-11</p>	<p>ST-9949 STRUT MOUNT(Front) (UPPER SPR ISO)</p> <p>HYUNDAI PASSENGER CAR 2007-12</p>	<p>ST-9959 STRUT MOUNT(Rear) (UPPER SPR SEAT)</p> <p>HONDA SPORT UTILITY 2007-11</p>	<p>ST-9977 STRUT MOUNT(Front) (UPPER SPR SEAT)</p> <p>HONDA VAN 2005-07</p>
			
<p>ST-9946 STRUT MOUNT(Rear)</p> <p>HONDA SPORT UTILITY 2007-11</p>	<p>ST-9955 STRUT MOUNT(Front) (UPPER SPR SEAT)</p> <p>TOYOTA PASSENGER CAR 2009-15</p>	<p>ST-9962 STRUT MOUNT(Front) (UPPER SPR SEAT)</p> <p>SCION PASSENGER CAR 2005-10 TOYOTA PASSENGER CAR 2003-09</p>	<p>ST-9978 STRUT MOUNT(Front) (UPPER SPR ISO)</p> <p>HONDA VAN 2005-07</p>
			
<p>ST-9947 STRUT MOUNT(Rear)</p> <p>CHRYSLER PASSENGER CAR 2001-05 DODGE PASSENGER CAR 2001-05 EAGLE PASSENGER CAR 1995-98 MITSUBISHI PASSENGER CAR 1995-05</p>	<p>ST-9956 STRUT MOUNT(Front) (UPPER SPR ISO)</p> <p>TOYOTA PASSENGER CAR 2003-13</p>	<p>ST-9969 STRUT MOUNT(Rear) (UPPER SPR ISO)</p> <p>CHRYSLER PASSENGER CAR 2001-05 DODGE PASSENGER CAR 2001-05</p>	<p>ST-9989 STRUT MOUNT(Front) (LOWER SPR ISO)</p>
<p>(Continued Next Column)</p>			<p>(Continued Next Page)</p>

BUYER'S GUIDE

NUMERICAL LISTING - ILLUSTRATIONS

ST-9989 (Continued)

DODGE PASSENGER CAR 2013-16



ST-9998

**STRUT MOUNT(Front) (UPPER
SPR SEAT)**

KIA PASSENGER CAR 2006-11



ST-9999

**STRUT MOUNT(Front) (UPPER
SPR ISO)**

KIA PASSENGER CAR 2006-10



VI-7550

VIBRATION ISOLATOR KIT

FORD PASSENGER CAR 1992-11
FORD SPORT UTILITY 1997-06
LINCOLN PASSENGER CAR 1984-11
LINCOLN SPORT UTILITY 1998-06
MERCURY PASSENGER CAR ... 1990-11

CROSS REFERENCE

Mfg Part No	Our Part	Mfg Part No	Our Part	Mfg Part No	Our Part	Mfg Part No	Our Part
MONROE (cont.)		MONROE (cont.)		MONROE (cont.)		MONROE (cont.)	
903951	ST-3951	904937	ST-4937	905916	ST-5916	905987	ST-5987
903954	ST-3954	904938	ST-4938	905917	ST-5917	905988	ST-5988
903957	ST-3957	904939	ST-4939	905918	ST-5918	905989	ST-5989
903958	ST-3958	904940	ST-4940	905919	ST-5919	905990	ST-5990
903959	ST-3959	904941	ST-4941	905920	ST-5920	905992	ST-5992
903960	ST-3960	904942	ST-4942	905921	ST-5921	905993	ST-5993
903961	ST-3961	904943	ST-4943	905922	ST-5922	905994	ST-5994
903962	ST-3962	904944	ST-4944	905923	ST-5923	905995	ST-5995
903964	ST-3964	904945	ST-4945	905924	ST-5924	905996	ST-5996
903965	ST-3965	904948	ST-4948	905925	ST-5925	905997	ST-5997
903966	ST-3966	904949	ST-4949	905926	ST-5926	906914	ST-6914
903967	ST-3967	904950	ST-4950	905927	ST-5927	906915	ST-6915
903968	ST-3968	904951	ST-4951	905929	ST-5929	906916	ST-6916
903969	ST-3969	904952	ST-4952	905930	ST-5930	906917	ST-6917
903970	ST-3970	904953	ST-4953	905931	ST-5931	906918	ST-6918
903971	ST-3971	904954	ST-4954	905932	ST-5932	906919	ST-6919
903972	ST-3972	904955	ST-4955	905933	ST-5933	906920	ST-6920
903973	ST-3973	904956	ST-4956	905934	ST-5934	906921	ST-6921
903974	ST-3974	904957	ST-4957	905935	ST-5935	906922	ST-6922
903975	ST-3975	904958	ST-4958	905936	ST-5936	906923	ST-6923
903976	ST-3976	904959	ST-6919	905937	ST-5937	906924	ST-6924
903977	ST-3977	904960	ST-6920	905938	ST-5938	906925	ST-6925
903978	ST-3978	904962	ST-4962	905939	ST-5939	906926	ST-6926
903980	ST-3980	904965	ST-4965	905940	ST-5940	906927	ST-6927
903982	ST-3982	904966	ST-4966	905941	ST-5941	906928	ST-6928
903983	ST-3983	904968	ST-4968	905942	ST-5942	906929	ST-6929
903984	ST-3984	904970	ST-4970	905943	ST-5943	906930	ST-6930
903985	ST-3985	904971	ST-4971	905944	ST-5944	906931	ST-6931
903986	ST-3986	904972	ST-4972	905945	ST-5945	906932	ST-6932
903987	ST-3987	904973	ST-4973	905946	ST-5946	906934	ST-6934
903988	ST-3988	904974	ST-4974	905947	ST-5947	906935	ST-6935
903989	ST-3989	904975	ST-4975	905948	ST-5948	906936	ST-6936
903990	ST-3990	904976	ST-4976	905949	ST-5949	906937	ST-6937
903991	ST-3991	904977	ST-4977	905950	ST-5950	906938	ST-6938
903992	ST-3992	904978	ST-6914	905951	ST-5951	906939	ST-6939
903993	ST-3993	904979	ST-4979	905952	ST-5952	906940	ST-6940
903994	ST-3994	904980	ST-4980	905953	ST-5953	906941	ST-6941
903995	ST-3995	904981	ST-4981	905954	ST-5954	906942	ST-6942
903997	ST-3997	904983	ST-4983	905955	ST-5955	906943	ST-6943
903998	ST-3998	904984	ST-4984	905956	ST-5956	906944	ST-6944
903999	ST-3999	904985	ST-4985	905957	ST-5957	906945	ST-6945
904900	ST-4900	904987	ST-4987	905958	ST-5958	906946	ST-6946
904902	ST-4902	904988	ST-4988	905959	ST-5959	906947	ST-6947
904903	ST-4903	904989	ST-4989	905960	ST-5960	906948	ST-6948
904904	ST-4904	904990	ST-4990	905961	ST-5961	906949	ST-6949
904905	ST-4905	904991	ST-4991	905962	ST-5962	906950	ST-6950
904906	ST-4906	904992	ST-4992	905963	ST-5963	906951	ST-6951
904907	ST-4907	904993	ST-4993	905964	ST-5964	906952	ST-6952
904908	ST-4908	904994	ST-4994	905965	ST-5965	906953	ST-6953
904909	ST-4909	904995	ST-4995	905966	ST-5966	906955	ST-6955
904910	ST-4910	904996	ST-4996	905967	ST-5967	906956	ST-6956
904911	ST-4911	904997	ST-4997	905968	ST-5968	906957	ST-6957
904912	ST-4912	904998	ST-4998	905969	ST-5969	906958	ST-6958
904913	ST-4913	904999	ST-4999	905970	ST-5970	906959	ST-6959
904915	ST-4915	905900	ST-5900	905971	ST-5971	906960	ST-6960
904916	ST-4916	905901	ST-5901	905972	ST-5972	906961	ST-6961
904918	ST-4918	905902	ST-5902	905973	ST-5973	906962	ST-6962
904919	ST-4919	905903	ST-5903	905974	ST-5974	906963	ST-6963
904920	ST-4920	905904	ST-5904	905975	ST-5975	906964	ST-6964
904921	ST-4921	905905	ST-5905	905976	ST-5976	906965	ST-6965
904922	ST-4922	905906	ST-5906	905977	ST-5977	906966	ST-6966
904923	ST-4923	905907	ST-5907	905978	ST-5978	906967	ST-6967
904924	ST-4924	905908	ST-5908	905979	ST-5979	906968	ST-6968
904925	ST-4925	905909	ST-5909	905980	ST-5980	906969	ST-6969
904927	ST-4927	905910	ST-5910	905981	ST-5981	906970	ST-6970
904932	ST-4932	905911	ST-5911	905982	ST-5982	906971	ST-6971
904933	ST-4933	905912	ST-5912	905983	ST-5983	906973	ST-6973
904934	ST-4934	905913	ST-5913	905984	ST-5984	906974	ST-6974
904935	ST-4935	905914	ST-5914	905985	ST-5985	906975	ST-6975
904936	ST-4936	905915	ST-5915	905986	ST-5986	906976	ST-6976

CROSS REFERENCE

Mfg Part No	Our Part	Mfg Part No	Our Part	Mfg Part No	Our Part	Mfg Part No	Our Part
MONROE (cont.)		MONROE (cont.)		MONROE (cont.)		MONROE (cont.)	
906977	ST-6977	907953	ST-7953	908928	ST-8928	909911	ST-9911
906980	ST-6980	907954	ST-7954	908929	ST-8929	909912	ST-9912
906981	ST-6981	907955	ST-7955	908930	ST-8930	909913	ST-9913
906982	ST-6982	907956	ST-7956	908931	ST-8931	909914	ST-9914
906983	ST-6983	907957	ST-7957	908932	ST-8932	909915	ST-9915
906984	ST-6984	907958	ST-7958	908933	ST-8933	909916	ST-9916
906985	ST-6985	907959	ST-7959	908934	ST-8934	909917	ST-9917
906986	ST-6986	907960	ST-7960	908937	ST-8937	909918	ST-9918
906987	ST-6987	907961	ST-7961	908938	ST-8938	909920	ST-9920
906988	ST-6988	907962	ST-7962	908939	ST-8939	909921	ST-9921
906989	ST-6989	907963	ST-7963	908941	ST-8941	909922	ST-9922
906990	ST-6990	907964	ST-7964	908942	ST-8942	909923	ST-9923
906994	ST-6994	907965	ST-7965	908943	ST-8943	909924	ST-9924
906995	ST-6995	907966	ST-7966	908946	ST-8946	909925	ST-9925
906996	ST-6996	907967	ST-7967	908947	ST-8947	909927	ST-9927
906997	ST-6997	907968	ST-7968	908948	ST-8948	909929	ST-9929
906998	ST-6998	907969	ST-7969	908949	ST-8949	909930	ST-9930
906999	ST-6999	907972	ST-7972	908950	ST-8950	909931	ST-9931
907900	ST-7900	907973	ST-7973	908951	ST-8951	909937	ST-9937
907901	ST-7901	907974	ST-7974	908952	ST-8952	909938	ST-9938
907902	ST-7902	907975	ST-7975	908953	ST-8953	909939	ST-9939
907903	ST-7903	907976	ST-7976	908954	ST-8954	909940	ST-9940
907904	ST-7904	907977	ST-7977	908955	ST-8955	909942	ST-9942
907905	ST-7905	907978	ST-7978	908956	ST-8956	909943	ST-9943
907906	ST-7906	907979	ST-7979	908957	ST-8957	909945	ST-9945
907907	ST-7907	907980	ST-7980	908958	ST-8958	909946	ST-9946
907908	ST-7908	907981	ST-7981	908959	ST-8959	909947	ST-9947
907909	ST-7909	907982	ST-7982	908960	ST-8960	909948	ST-9948
907910	ST-7910	907983	ST-7983	908961	ST-8961	909949	ST-9949
907911	ST-7911	907984	ST-7984	908962	ST-8962	909955	ST-9955
907912	ST-7912	907985	ST-7985	908965	ST-8965	909956	ST-9956
907913	ST-7913	907986	ST-7986	908966	ST-8966	909957	ST-9957
907914	ST-7914	907987	ST-7987	908967	ST-8967	909959	ST-9959
907915	ST-7915	907988	ST-7988	908968	ST-8968	909962	ST-9962
907916	ST-7916	907989	ST-7989	908969	ST-8969	909969	ST-9969
907917	ST-7917	907990	ST-7990	908970	ST-8970	909977	ST-9977
907919	ST-7919	907991	ST-7991	908971	ST-8971	909978	ST-9978
907920	ST-7920	907992	ST-7992	908972	ST-8972	909988	ST-9988
907921	ST-7921	907993	ST-7993	908973	ST-8973	909989	ST-9989
907922	ST-7922	907994	ST-7994	908975	ST-8975	909998	ST-9998
907923	ST-7923	907995	ST-7995	908976	ST-8976	909999	ST-9999
907924	ST-7924	907996	ST-7996	908977	ST-8977	MA824	AS-7404
907925	ST-7925	907997	ST-7997	908978	ST-8978	MOOG	
907926	ST-7926	907998	ST-7998	908979	ST-8979	K10117	ST-2968
907927	ST-7927	907999	ST-7999	908980	ST-8980	K10118	ST-2969
907928	ST-7928	908900	ST-8900	908981	ST-8981	K160002	ST-5909
907929	ST-7929	908903	ST-8903	908982	ST-8982	K160003	ST-5908
907930	ST-7930	908904	ST-8904	908983	ST-8983	K160004	ST-7990
907931	ST-7931	908905	ST-8905	908984	ST-8984	K160005	ST-5925
907932	ST-7932	908907	ST-8907	908988	ST-8988	K160006	ST-5926
907933	ST-7933	908908	ST-8908	908989	ST-8989	K160007	ST-8903
907934	ST-7934	908909	ST-8909	908990	ST-8990	K160008	ST-8904
907935	ST-7935	908910	ST-8910	908991	ST-8991	K160009	ST-8905
907936	ST-7936	908911	ST-8911	908992	ST-8992	K160010	ST-5941
907937	ST-7937	908912	ST-8912	908993	ST-8993	K160012	ST-5948
907938	ST-7938	908913	ST-8913	908994	ST-8994	K160014	ST-4950
907939	ST-7939	908914	ST-8914	908995	ST-10004	K160019	ST-7907
907940	ST-7940	908915	ST-8915	908997	ST-8997	K160020	ST-6932
907941	ST-7941	908916	ST-8916	908998	ST-8998	K160023	ST-5920
907942	ST-7942	908917	ST-8917	908999	ST-8999	K160025	ST-5952
907943	ST-7943	908918	ST-8918	909901	ST-9901	K160026	ST-5953
907944	ST-7944	908919	ST-8919	909902	ST-9902	K160027	ST-5932
907945	ST-7945	908920	ST-8920	909903	ST-9903	K160031	ST-7946
907946	ST-7946	908921	ST-8921	909904	ST-9904	K160049	ST-5913
907947	ST-7947	908922	ST-8922	909905	ST-9905	K160050	ST-5922
907948	ST-7948	908923	ST-8923	909906	ST-9906	K160051	ST-6917
907949	ST-7949	908924	ST-8924	909907	ST-9907	K160052	ST-5907
907950	ST-7950	908925	ST-8925	909908	ST-9908	K160056	ST-5923
907951	ST-7951	908926	ST-8926	909909	ST-9909	K160058	ST-8949
907952	ST-7952	908927	ST-8927	909910	ST-9910		

CROSS REFERENCE

Mfg Part No	Our Part	Mfg Part No	Our Part	Mfg Part No	Our Part	Mfg Part No	Our Part
MOOG (cont.)		MOOG (cont.)		MOOG (cont.)		MOOG (cont.)	
K8693	ST-1999	K90296	ST-3938	K9656	ST-1944	K9799	ST-3986
K8694	ST-2951	K90298	ST-3950	K9662	ST-1981	K9800	ST-3988
K8696	ST-2952	K90299	ST-4979	K9668	ST-2911	K9801	ST-3989
K8697	ST-2936	K90301	ST-3954	K9670	ST-2925	K9843	ST-4906
K8741	ST-2953	K90304	ST-3957	K9671	ST-6916	K9844	ST-3913
K8742	ST-2944	K90307	ST-4904	K9679	ST-2933	K9845	ST-3949
K8743	ST-2954	K90322	ST-4966	K9681	ST-1992	K9847	ST-3990
K8775	ST-2970	K90323	ST-4975	K9683	ST-2919	K9848	ST-2991
K8795	ST-2976	K90326	ST-4955	K9685	ST-2902	K9849	ST-3948
K8796	ST-2989	K90327	ST-4932	K9686	ST-2903	K9850	ST-3943
K8803	ST-3905	K90328	ST-4933	K9687	ST-2915	K9851	ST-3951
K8993	ST-3905	K90329	ST-4934	K9689	ST-2964	K9904	ST-5912
K8994	ST-3964	K90330	ST-4935	K9690	ST-2957	MOTORCRAFT	
K8995	ST-4936	K90412	ST-4992	K9691	ST-2959	AD1066	ST-9914
K8996	ST-3966	K90449	ST-6920	K9692	ST-2958	AD1084	ST-9905
K8997	ST-3967	K90648	ST-4996	K9693	ST-2960	AD1095	ST-9915
K8998	ST-3968	K90648	ST-4997	K9694	ST-2962	AD1100	ST-9906
K90212	ST-3912	K90649	ST-6919	K9695	ST-2966	AD1134	ST-9916
K90214	ST-2967	K90651	ST-3909	K9697	ST-2950	McQuay	
K90215	ST-3935	K90652	ST-3908	K9701	ST-2942	SM6030	ST-1905
K90216	ST-3936	K90653	ST-4999	K9703	ST-2943	SM6031	ST-1907
K90217	ST-3940	K90654	ST-4998	K9704	ST-1975	SM6032	ST-1906
K90218	ST-3941	K90655	ST-6914	K9705	ST-2901	SM6033	ST-1908
K90219	ST-3942	K90657	ST-5950	K9706	ST-1976	SM6076	ST-1903
K90220	ST-2975	K90658	ST-4989	K9707	ST-2912	SM6077	ST-1904
K90221	ST-2974	K90721	ST-4983	K9708	ST-1977	SM6084	ST-1951
K90222	ST-6977	K90724	ST-5945	K9709	ST-2922	SM6091	ST-1913
K90225	ST-3946	K90725	ST-4951	K9710	ST-1979	SM6092	ST-1934
K90226	ST-2985	K9390	ST-2963	K9711	ST-2926	SM7000	ST-1901
K90227	ST-2978	K9392	ST-1937	K9713	ST-2927	SM7003	ST-1942
K90227	ST-2980	K9394	ST-1903	K9714	ST-1983	SM7004	ST-2903
K90228	ST-3962	K9443	ST-6915	K9715	ST-2920	SM7005	ST-2905
K90229	ST-3978	K9476	ST-1947	K9716	ST-1984	SM7006	ST-2904
K90230	ST-3982	K9478	ST-1958	K9717	ST-2921	SM7007	ST-1965
K90231	ST-3984	K9480	ST-1939	K9718	ST-1985	SM7012	ST-2920
K90232	ST-3985	K9488	ST-1943	K9719	ST-2955	SM7013	ST-1971
K90233	ST-3993	K9492	ST-1940	K9720	ST-1987	SM7013	ST-1974
K90234	ST-3994	K9498	ST-1961	K9721	ST-2961	SM7014	ST-1960
K90235	ST-2988	K9506	ST-1962	K9722	ST-1988	SM7015	ST-1956
K90236	ST-3903	K9549	ST-2904	K9723	ST-2937	SM7016	ST-1925
K90237	ST-3906	K9555	ST-2905	K9724	ST-1989	SM7019	ST-1930
K90238	ST-3995	K9557	ST-2913	K9725	ST-2935	SM7022	ST-1970
K90240	ST-4903	K9559	ST-2924	K9727	ST-2940	SM7024	ST-1954
K90241	ST-4905	K9560	ST-1911	K9728	ST-1993	SM7025	ST-1955
K90242	ST-4907	K9561	ST-2928	K9729	ST-2939	SM7026	ST-1902
K90243	ST-4908	K9562	ST-1912	K9730	ST-1994	SM7027	ST-2901
K90244	ST-4909	K9563	ST-2931	K9731	ST-2938	SM7028	ST-2901
K90245	ST-4910	K9564	ST-1909	K9732	ST-1995	SM7029	ST-1929
K90267	ST-3916	K9565	ST-2932	K9734	ST-1996	SM7030	ST-1946
K90268	ST-3917	K9566	ST-1910	K9762	ST-2990	SM7033	ST-1929
K90269	ST-3918	K9569	ST-2934	K9773	ST-3939	SM7036	ST-1973
K90270	ST-3919	K9579	ST-2918	K9774	ST-2986	SM7036	ST-1991
K90271	ST-3920	K9583	ST-2906	K9775	ST-3911	SM7037	ST-1922
K90272	ST-3921	K9585	ST-2917	K9777	ST-2956	SM7038	ST-1924
K90273	ST-3922	K9591	ST-2914	K9778	ST-3915	SM7039	ST-1923
K90274	ST-3944	K9592	ST-1904	K9779	ST-2987	SM7040	ST-1921
K90276	ST-3959	K9622	ST-1941	K9780	ST-2982	SM7043	ST-2992
K90278	ST-3960	K9624	ST-1965	K9783	ST-2983	SM7044	ST-1928
K90281	ST-3961	K9628	ST-1942	K9784	ST-2981	SM7046	ST-1934
K90282	ST-5997	K9632	ST-1966	K9785	ST-3907	SM7048	ST-1953
K90285	ST-3904	K9634	ST-1930	K9786	ST-3910	SM7049	ST-1940
K90286	ST-3997	K9636	ST-1959	K9787	ST-3983	SM7050	ST-1961
K90287	ST-3998	K9638	ST-1938	K9788	ST-3992	SM7052	ST-1939
K90288	ST-3999	K9640	ST-1948	K9789	ST-3991	SM7053	ST-6915
K90289	ST-4918	K9642	ST-1967	K9790	ST-2979	SM7054	ST-1938
K90290	ST-4900	K9644	ST-1968	K9794	ST-2984	SM7055	ST-1937
K90292	ST-4902	K9646	ST-1969	K9795	ST-3945	SM7056	ST-1932
K90293	ST-3914	K9648	ST-1932	K9796	ST-3947	SM7058	ST-1959
K90294	ST-3923	K9650	ST-1933	K9797	ST-2977	SM7059	ST-1963
K90295	ST-3937	K9652	ST-1960	K9798	ST-3987		



Westar Distribution, LLC
LIMITED WARRANTY

Any product sold by Westar Distribution, LLC, is warranted to be free from defects in material and workmanship for a period of 12 months or 12,000 miles, whichever comes first. Westar will not warrant any product that is not used in strict accordance with the manufacturer's instructions for use, operation, and installation. This limited warranty does not apply to any product which has been misused, altered, or used under excessive operating conditions beyond the manufacturer's instructions.

The liability of Westar Distribution, LLC is limited solely to the repair or replacement of defective products. Westar cannot be held responsible for the cost of any related parts, labor claims, or incidental expenses. Furthermore, Westar cannot be held responsible for any consequential damages, personal injuries, or damage to property.

Westar Distribution, LLC will not be held responsible for any transportation costs incurred due to the return of parts to Westar or the return of replacement products to the buyer. Finally, Westar cannot be held liable for any damages, losses, or delays of products due to war, government restrictions or restraints, strikes, material shortage beyond the control of Westar Distribution, LLC, or acts of God

INSTALLATION INSTRUCTIONS

Before installing any part, it is most important to check all inserts, rods, and bearings to be sure that they are properly seated and move as per manufacturer specifications. Other causes for early or unusual failure of a part can be eliminated by a close inspection for other worn or damaged parts.

IMPORTANT NOTICE

While the utmost care was used in compiling the information in this catalog, we cannot assume any responsibility for errors, omissions, or the inaccuracy in data supplied to us. All parts shown within are intended as replacement parts. The use of any manufacturer's trademarks, part number or terminology is for the sole purpose of the users of this catalog to select the correct replacement part.

 **Address**

East Coast:

350 Winmeyer Ave. Suite: B
Odenton, MD 21113
East Coast Fax to: (866)730-9718

West Coast Distribution Center:

1566 Archibald Ave.
Ontario, CA 91761
(714)909-0830

 **Toll Free**

800-WESTAR4

 **Email**

orders@westarparts.com

 **Website**

www.westarparts.com

